

SU-7 SERIES SH SERIES

Slim Body Automatic Sensitivity Setting Photoelectric Sensor **Amplifier-separated**



Simple and suitable
for compact design



Simple automatic sensitivity setting

Anyone can achieve the optimum sensitivity by just pressing two buttons.

- Aligning with the mark to be detected, press the 'ON' button.

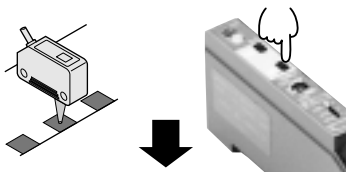

- Aligning with the background, press the 'OFF' button.

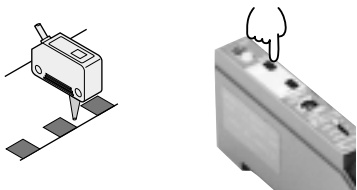

Thickness: 10 mm 0.394 in

Installation space can be greatly reduced as the SU-7 amplifier is just 10 mm 0.394 in thick.

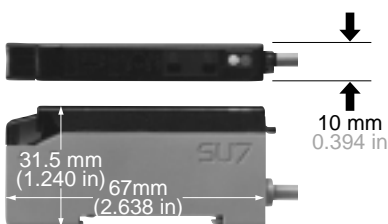

Quick wire connection

A snap of the lever secures the connection of the sensor head cables on the SU-7 amplifier. It is no longer required to strip the wire insulation. Further, the exclusive stripper (accessory) can be used to easily peel off the sensor cable outer sheath.

- Strip the cable sheaths with the exclusive stripper.
- Insert the wires into the
- Flip up and lock the lever.

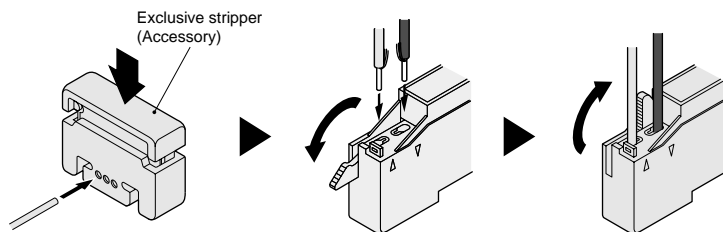

Caution: The outer fluorine sheath of the chemical resistant type sensor head, SH-61R, cannot be cut off with the dedicated stripper.

Nine advanced functions for versatile sensing

- Limit sensitivity setting** **All models**
Sensitivity for detection of minute differences can be set by the press of one button without an object being present.
- Sensitivity shift** **All models**
The set threshold level can be shifted from the center towards either ON or OFF level.
- Remote sensitivity selection** **SU-79**
The amplifier stores four channels of sensitivities. They can be selected by the remote inputs.
- Remote sensitivity setting** **SU-77**
The sensitivity can be adjusted from a remote place.
- External synchronization** **SU-75**
The timing for sensing can be specified by an external input.
- Test input (emission halt)** **SU-75**
Convenient for start-up inspection.
- Sensitivity margin indication** **All models**
The number of blinks of the stability indicator indicates the degree of sensitivity margin.
- ON-delay / OFF-delay timer** **SU-7 SU-77 SU-79 SU-7J**
The timer can be selected for either ON-delay or OFF-delay of 0 to 5 sec.
- Interference prevention** **All models**
Two sensor heads can be mounted close together.

Refer to 'PRECAUTIONS FOR PROPER USE' on p.396~ for further details.

APPLICATIONS

Determining position of lead frame

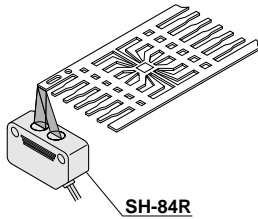

Identifying top face from bottom face of chip components

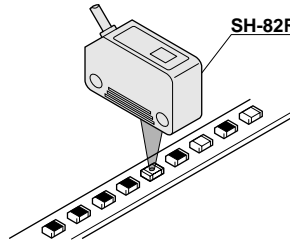

Detecting red mark on white paper

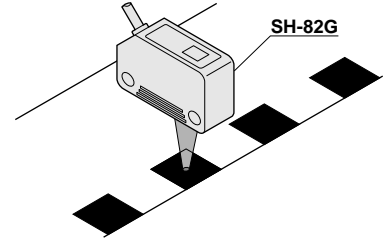

Detecting transparent glass substrates in cassette

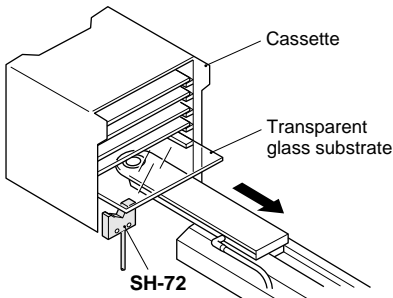

Detecting IC height

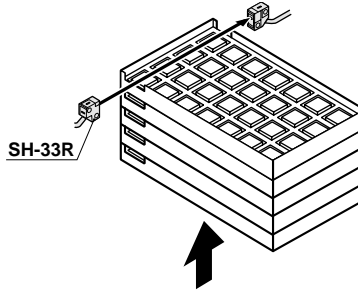

Detecting wafer cassette in quartz tank containing cleaning liquid

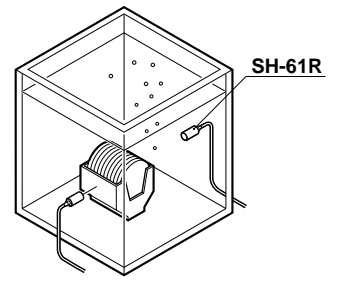

Line-focus type / SH-84R



Spot size
1 × 4 mm
0.039 × 0.157 in

- Suitable for detecting printed characters
It can be used to detect printed characters because of its line shaped projected area of 1 × 4 mm 0.039 × 0.157 in.

(e.g.) Detecting polarity marks on capacitors

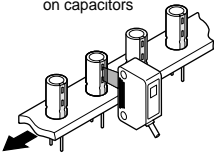

- Strong against position deviation
Since it makes a judgment based upon the total light incident on the sensing area, it is not easily affected by a deviation in sensing object position.

Pinpoint type with red LED beam / SH-82R

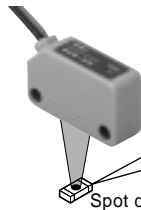

Spot diameter
φ0.7 mm φ0.028 in

- Suitable for tiny object sensing

- Spot diameter: φ0.7 mm φ0.028 in
Top / bottom face of a chip component can be easily discriminated.

Ultra-slim type / SH-2□

- Compact size: 0.3cm³ Thickness: 3 mm 0.118 in
- Versatile mounting
Diffuse reflective type sensor head
• Front sensing



Thru-beam type sensor head
• Front sensing • Side sensing

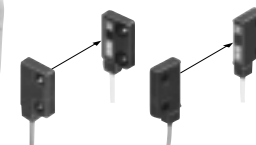

Pinpoint type with green LED beam / SH-82G



Spot diameter
φ1 mm φ0.039 in

- Red / white color discrimination

Discrimination between red / white, red / yellow or red / orange, which is difficult with the red LED type, is easy with SH-82G.

Chemical resistant type / SH-61R

- Strong against chemicals

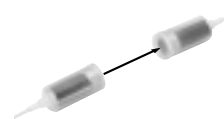

Since the sensor heads and the attached cables are covered by fluorine resin, SH-61R can be used in a harsh chemical environment. Moreover, it has a long sensing range of 2.5 m 8.202 ft.

Glass substrate detection type / SH-72



- Reliable glass substrate detection
Its unique optical system enables detection of transparent glass plate, as well as, specular film deposited glass plate at the same distance.
- No dead zone
- Repeatability: 0.03 mm 0.001 in
- Not affected by background

Ultra-small type / SH-3□

- Sensor head with indicator
An operation indicator, which enables an easy check of the operation at site, has been incorporated.

Operation indicator (Red)

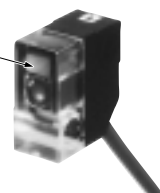







- 2 m 6.562 ft long sensing range with red LED beam (SH-33R)
Visible red LED beam makes alignment easy.

SU-7/SH

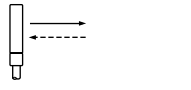
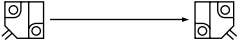
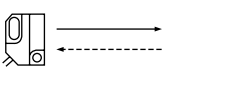
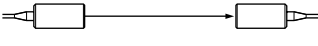
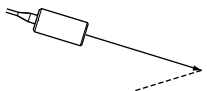
ORDER GUIDE

Sensor heads

Type	Appearance	Sensing range	Model No.	Emitting element	Operation indicator
Ultra-slim type	Thru-beam Front sensing		SH-21	Infrared LED	—
	Thru-beam Side sensing		SH-21E		
	Diffuse reflective Front sensing		SH-22		
Ultra-small type	Thru-beam	 1 m 3.281 ft 100 mm 3.937 in 2 m 6.562 ft	SH-31R SH-31G SH-33R	Red LED Green LED	Incorporated
	Diffuse reflective		SH-32R	Red LED	
	Chemical resistant type	Thru-beam		SH-61R	
Convergent reflective (Using optional mounting bracket MS-SH6-2)		 5 to 80 mm 0.197 to 3.150 in (Convergent point: 25 mm 0.984 in)			
Mark sensor	Pinpoint	 10 to 14 mm 0.394 to 0.551 in (Convergent point: 12 mm 0.472 in) (Spot diameter: φ0.7 mm φ0.028 in)	SH-82R	Red LED	
	Line-focus	 10 to 14 mm 0.394 to 0.551 in (Convergent point: 12 mm 0.472 in) (Spot diameter: φ1 mm φ0.039 in)	SH-82G	Green LED	
		 17 to 23 mm 0.669 to 0.906 in (Convergent point: 20 mm 0.787 in) (Spot size: 1 X 4 mm 0.039 X 0.157 in)	SH-84R	Red LED	
Class substrate detection sensor		0.5 to 7.5 mm 0.020 to 0.295 in (with transparent glass substrate)	SH-72	Infrared LED	—

Amplifiers

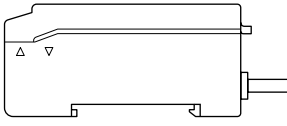
Type	Appearance	Model No.	Functions (●: Incorporated)										
			Automatic sensitivity setting	Sensitivity shift	Limit sensitivity setting	Remote sensitivity setting	Remote sensitivity selection	Sensitivity margin indication	External synchronization	Test input (emission halt)	Timer	Interference prevention	
NPN output type		Standard type	SU-7	●	●	●	—	—	●	—	—	●	●
		Plug-in connector type	SU-7J	●	●	●	—	—	●	—	—	●	●
		External synchronization input type	SU-75	●	●	●	—	—	●	●	●	—	●
		Remote sensitivity adjustment type	SU-77	●	●	●	●	—	●	—	—	●	●
		Remote sensitivity selection type	SU-79	●	●	●	—	●	●	—	—	●	●
PNP output type	Standard type	SU-7P	●	●	●	—	—	●	—	—	●	●	

ORDER GUIDE

Plug-in connector type

It is usable with the sensor & wire-saving link system **S-LINK**, sensor block for simple wiring **SL-BMW** or **SL-BW**, or with connector attached cable **CN-54-C2** or **CN-54-C5**.

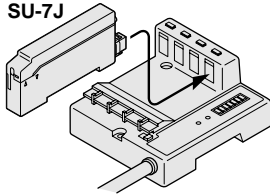

Sensor & wire-saving link system
S-LINK
(Refer to p.1030~ for details.)

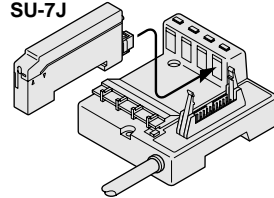

Sensor block for simple wiring
SL-BMW, SL-BW
(Refer to p.882~ for details.)

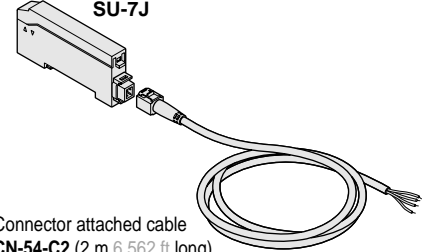

Connector attached cable
CN-54-C2 (2 m 6.562 ft long)
CN-54-C5 (5 m 16.404 ft long)

Accessories

• **MS-DIN-2** (Amplifier mounting bracket)

• **SU-CT1** (Exclusive stripper)

• **MS-SH6-1**
(Sensor head mounting bracket for **SH-61R**)

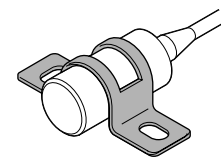
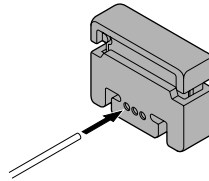
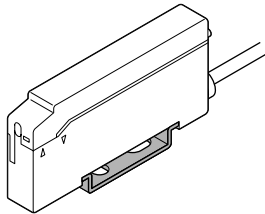

OPTIONS

Designation	Model No.	Description																													
Slit mask (For SH-31R , SH-31G and SH-33R only)	OS-SS3	This is a convenient slit mask having four types of slits.																													
		<table border="1"> <thead> <tr> <th rowspan="2">Slit size</th> <th rowspan="2">Fitting</th> <th colspan="3">Sensing range</th> <th rowspan="2">Min. sensing object</th> </tr> <tr> <th>SH-31R</th> <th>SH-31G</th> <th>SH-33R</th> </tr> </thead> <tbody> <tr> <td rowspan="2">0.5 × 3 mm 0.020 × 0.118 in</td> <td>One side</td> <td>500 mm 19.685 in</td> <td>50 mm 1.969 in</td> <td>750 mm 29.528 in</td> <td rowspan="2">φ3 mm φ0.118 in</td> </tr> <tr> <td>Both sides</td> <td>250 mm 9.843 in</td> <td>25 mm 0.984 in</td> <td>400 mm 15.748 in</td> </tr> <tr> <td rowspan="2">1 × 3 mm 0.039 × 0.118 in</td> <td>One side</td> <td>700 mm 27.559 in</td> <td>70 mm 2.756 in</td> <td>1,000 mm 39.370 in</td> <td rowspan="2">φ3 mm φ0.118 in</td> </tr> <tr> <td>Both sides</td> <td>500 mm 19.685 in</td> <td>50 mm 1.969 in</td> <td>750 mm 29.528 in</td> </tr> </tbody> </table>	Slit size	Fitting	Sensing range			Min. sensing object	SH-31R	SH-31G	SH-33R	0.5 × 3 mm 0.020 × 0.118 in	One side	500 mm 19.685 in	50 mm 1.969 in	750 mm 29.528 in	φ3 mm φ0.118 in	Both sides	250 mm 9.843 in	25 mm 0.984 in	400 mm 15.748 in	1 × 3 mm 0.039 × 0.118 in	One side	700 mm 27.559 in	70 mm 2.756 in	1,000 mm 39.370 in	φ3 mm φ0.118 in	Both sides	500 mm 19.685 in	50 mm 1.969 in	750 mm 29.528 in
		Slit size			Fitting	Sensing range			Min. sensing object																						
			SH-31R	SH-31G		SH-33R																									
		0.5 × 3 mm 0.020 × 0.118 in	One side	500 mm 19.685 in	50 mm 1.969 in	750 mm 29.528 in	φ3 mm φ0.118 in																								
Both sides	250 mm 9.843 in		25 mm 0.984 in	400 mm 15.748 in																											
1 × 3 mm 0.039 × 0.118 in	One side	700 mm 27.559 in	70 mm 2.756 in	1,000 mm 39.370 in	φ3 mm φ0.118 in																										
	Both sides	500 mm 19.685 in	50 mm 1.969 in	750 mm 29.528 in																											
Sensor head mounting bracket (For the ultra-small type only)	MS-SS3-1	Mounting bracket for the ultra-small sensor head (The thru-beam type sensor head needs two brackets)																													
Sensor head mounting bracket (For the mark sensor only)	MS-DS-1	Mounting bracket for the mark sensor head																													
Sensor head mounting bracket (For SH-61R only)	MS-SH6-2	The emitter and the receiver are fixed together at an angle for use as a convergent reflective type sensor.																													
Sensor checker (Note)	CHX-SC2	It is useful for beam alignment of thru-beam type sensors. The optimum receiver position is given by indicators, as well as an audio signal.																													

Note: Refer to p.414~ for details of the sensor checker **CHX-SC2**.

Slit mask

• OS-SS3

The sensor head and the slit mask are mounted together.

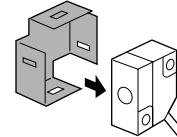

Sensor head mounting bracket

• MS-SS3-1

• MS-DS-1

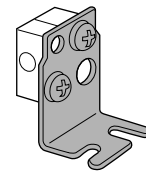

Two M3 (length 12 mm 0.472 in) screws with washers are attached.

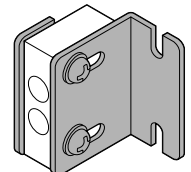

Two M3 (length 14 mm 0.551 in) screws with washers are attached.

• MS-SH6-2

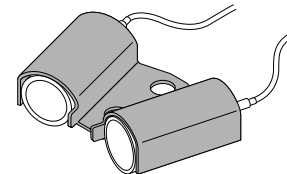

No screw is attached.

Sensor checker

• CHX-SC2

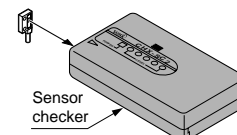

Sensor checker

SU-7/SH

SPECIFICATIONS

Sensor heads (for general use)

Item	Model No.	Ultra-slim type			Ultra-small type			
		Thru-beam		Diffuse reflective	Thru-beam			Diffuse reflective
		Front sensing	Side sensing		Red LED	Green LED	Red LED	
		SH-21	SH-21E	SH-22	SH-31R	SH-31G	SH-33R	SH-32R
Applicable amplifiers	SU-7 series							
Sensing range	300 mm 11.811 in			50 mm 1.969 in (Note 1)	1 m 3.281 ft	100 mm 3.937 in	2 m 6.562 ft	100 mm 3.937 in (Note 1)
Sensing object	Min. ϕ 0.3 mm ϕ 0.012 in opaque object (under the optimum condition) (Note 2)			Min. ϕ 0.3 mm ϕ 0.012 in copper wire (with 3 mm 0.118 in setting distance and at the max. sensitivity)	Min. ϕ 1 mm ϕ 0.039 in opaque object (with 1 m 3.281 ft setting distance and at the optimum sensitivity) (Note 3)	Min. ϕ 1 mm ϕ 0.039 in opaque object (with 100 mm 3.937 in setting distance and at the optimum sensitivity) (Note 3)	Min. ϕ 1 mm ϕ 0.039 in opaque object (with 2 m 6.562 ft setting distance and at the optimum sensitivity) (Note 3)	Opaque, translucent or transparent object
Hysteresis	—————			15 % or less of operation distance	—————			15 % or less of operation distance
Repeatability (perpendicular to sensing axis)	0.03 mm 0.001 in or less			0.15 mm 0.006 in or less	0.1 mm 0.004 in or less			0.5 mm 0.020 in or less
Operation indicator	—————			Red LED (lights up when the sensing output of the amplifier is ON, incorporated on the emitter of the thru-beam type sensor head)				
Environmental resistance	Pollution degree	—————			3 (Industrial environment)			
	Protection	IP62 (IEC)			IP66 (IEC)			
	Ambient temperature	- 10 to + 60 °C + 14 to + 140 °F (No dew condensation or icing allowed) Storage: - 20 to + 70 °C - 4 to + 158 °F			- 25 to + 60 °C - 13 to + 140 °F (No dew condensation or icing allowed) Storage: - 30 to + 70 °C - 22 to + 158 °F			
	Ambient humidity	35 to 85 % RH, Storage: 35 to 85 % RH						
	Ambient illuminance	Sunlight: 11,000 lx at the light-receiving face, Incandescent light: 3,500 lx at the light-receiving face						
	Vibration resistance	10 to 55 Hz frequency, 1.5 mm 0.059 in amplitude in X, Y and Z directions for two hours each						
	Shock resistance	500 m/s ² acceleration (50 G approx.) in X, Y and Z directions for three times each						
Emitting element	Infrared LED (modulated)			Red LED (modulated)	Green LED (modulated)	Red LED (modulated)		
Material	Enclosure: Polycarbonate (glass fiber reinforced)			Enclosure: ABS, Lens: Polycarbonate				
Cable	0.089 mm ² (ultra-slim type: 0.057 mm ²) single core (diffuse reflective type: two parallel single core wires) shielded cable, 3 m 9.843 ft long							
Cable extension	Extension up to total 5 m 16.404 ft (ultra-small type: 10 m 32.808 ft) is possible with an equivalent cable (thru-beam type: both emitter and receiver).							
Weight	Emitter: 12 g approx. Receiver: 12 g approx.		24 g approx.	Emitter: 10 g approx. Receiver: 10 g approx.			20 g approx.	
Accessory	Sensor head mounting screw: 2 sets (SH-22: 1 set)							

Notes: 1) The sensing range of the diffuse reflective type sensor is specified for white non-glossy paper (50 × 50 mm 1.969 × 1.969 in) as the object.

2) The optimum condition is the condition when the sensitivity is adjusted so that the operation indicator just lights up at the given distance in the light received condition.

3) The optimum sensitivity stands for the sensitivity level when the operation indicator just lights up in the light received condition.

SPECIFICATIONS

Sensor heads (for special use)

Item	Model No.	Chemical resistant type	Mark sensor			Glass substrate detection sensor
		Thru-beam	Pinpoint		Line-focus	
			Red LED	Green LED		
		SH-61R	SH-82R	SH-82G	SH-84R	SH-72
Applicable amplifiers		SU-7 series				
Sensing range		2.5 m 8.202 ft (5 to 80 mm 0.197 to 3.150 in when mounted on optional mounting bracket (MS-SH6-2) and used as convergent reflective type (Conv. point: 25 mm 0.984 in) (Note 2))	10 to 14 mm 0.394 to 0.551 in (Convergent point: 12 mm 0.472 in) (Spot diameter: ϕ 0.7 mm ϕ 0.028 in) (Note 1)	10 to 14 mm 0.394 to 0.551 in (Convergent point: 12 mm 0.472 in) (Spot diameter: ϕ 1 mm ϕ 0.039 mm) (Note 1)	17 to 23 mm 0.669 to 0.906 in (Convergent point: 20 mm 0.787 in) (Spot size: 1 X 4 mm 0.039 X 0.157 in) (Note 1)	0.5 to 7.5 mm 0.020 to 0.295 in (with transparent glass plate)
Sensing object		Min. ϕ 5 mm ϕ 0.197 in opaque object (Min. ϕ 1 mm ϕ 0.039 in steel wire when mounted on optional mounting bracket (MS-SH6-2) and used as convergent reflective type (with 25 mm 0.984 in setting distance) and at the max. sensitivity (Note 3))	Min. 0.07 mm 0.003 in width black line on white paper (with 12 mm 0.472 in setting distance and at the optimum sensitivity) (Note 3)	Min. 0.2 mm 0.008 in width black line on white paper (with 12 mm 0.472 in setting distance and at the optimum sensitivity) (Note 3)	Min. 0.07 mm 0.003 in width black line on white paper (Note 4) (with 20 mm 0.787 in setting distance and at the optimum sensitivity) (Note 3)	<input type="checkbox"/> 24 mm <input type="checkbox"/> 0.945 in or more transparent glass, aluminum-evaporated mirror, etc.
Hysteresis		(15 % or less of operation distance) when mounted on optional mounting bracket (MS-SH6-2) and used as convergent reflective type.	10 % or less of operation distance			5 % or less of operation distance
Repeatability (perpendicular to sensing axis)		0.1 mm 0.004 in or less (0.1 mm 0.004 in or less of operation distance when mounted on optional mounting bracket (MS-SH6-2) and used as convergent reflective type. (with 25 mm 0.984 in setting distance) and at the optimum sensitivity (Note 3))	0.02 mm 0.0008 in or less	0.03 mm 0.001 in or less	0.03 mm 0.001 in or less (Note 5)	0.03 mm 0.001 in or less (along sensing axis)
Operation indicator		Orange LED (lights up when the sensing output of the amplifier is ON, incorporated on the emitter)	Red LED (lights up when the sensing output of the amplifier is ON)			
Environmental resistance	Protection	IP67 (IEC)				
	Ambient temperature	- 10 to + 55 °C + 14 to + 131 °F (No dew condensation or icing allowed), Storage: - 20 to + 70 °C - 4 to + 158 °F				- 10 to + 60 °C + 14 to + 140 °F (No dew condensation or icing allowed) Storage: - 10 to + 60 °C + 14 to + 140 °F
	Ambient humidity	35 to 85 % RH, Storage: 35 to 85 % RH				
	Ambient illuminance	Sunlight: 11,000 lx (SH-61R: 7,000 lx) at the light-receiving face, Incandescent light: 3,500 lx (SH-61R: 2,000 lx) at the light-receiving face				
	Vibration resistance	10 to 500 Hz frequency, 3 mm 0.118 in amplitude (SH-72: 10 to 55 Hz frequency, 1.5 mm 0.059 in amplitude) in X, Y and Z directions for two hours each				
	Shock resistance	500 m/s ² acceleration (50 G approx.) in X, Y and Z directions for three times each				
Emitting element		Red LED (modulated)		Green LED (modulated)	Red LED (modulated)	Infrared LED (modulated)
Material		Enclosure: Fluorine resin Cable sheath: Fluorine resin	Enclosure: Polycarbonate, Lens: Acrylic			Enclosure: Polycarbonate
Cable		0.089 mm ² single core, two parallel (SH-61R: 0.089 mm ² single core) shielded cables, 2 m 6.562 ft long (SH-72: 3 m 9.843 ft long)				
Cable extension		Extension up to total 5 m 16.404 ft is possible with an equivalent cable (SH-61R: both emitter and receiver).				
Weight		Emitter: 15 g approx. Receiver: 15 g approx.	20 g approx.			25 g approx.
Accessory		MS-SH6-1(Sensor head mounting bracket): 2 pcs.				

- Notes: 1) The sensing range of the mark sensor is specified for white non-glossy paper (50 X 50 mm 1.969 X 1.969 in) as the object.
 2) The sensing range for the chemical resistant type sensor used in the convergent reflective mode is specified for white non-glossy paper (150 X 150 mm 5.906 X 5.906 in) as the object.
 3) The optimum sensitivity stands for the sensitivity level when the operation indicator just lights up in the light received condition.
 4) The minimum sensing object for SH-84R is specified for the case when the sensor detects a black line with respect to the spot as shown below.

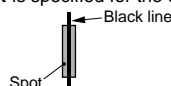

- 5) The repeatability for SH-84R is specified for the case when the sensing object approaches the spot sideways as shown below (0.12 mm 0.005 in if it approaches from above or below).

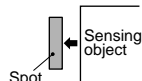

SU-7/SH

SPECIFICATIONS

Amplifiers

Item	Model No.	NPN output type				PNP output type	
		Standard type	External synchronization input type	Remote sensitivity setting type	Remote sensitivity selection type	Standard type	
		SU-7	SU-75	SU-77	SU-79	SU-7P	
Applicable sensor heads	SH series						
Supply voltage	12 to 24 V DC \pm 10 % Ripple P-P 10 % or less						
Current consumption	35 mA or less						
Sensing output	<p>NPN open-collector transistor</p> <ul style="list-style-type: none"> • Maximum sink current: 100 mA • Applied voltage: 30 V DC or less (between sensing output and 0 V) • Residual voltage: 1.0 V or less (at 100 mA sink current) 0.4 V or less (at 16 mA sink current) 					<p>PNP open-collector transistor</p> <ul style="list-style-type: none"> • Maximum source current: 100 mA • Applied voltage: 30 V DC or less (between sensing output and +V) • Residual voltage: 2.0 V or less (at 100 mA source current) 1.0 V or less (at 16 mA source current) 	
Utilization category	DC-12 or DC-13						
Output operation	Selectable either Light-ON or Dark-ON with the ON and OFF buttons (Selectable with the external inputs for SU-77)						
Short-circuit protection	Incorporated						
Self-diagnosis output	<p>NPN open-collector transistor</p> <ul style="list-style-type: none"> • Maximum sink current: 50 mA • Applied voltage: 30 V DC or less (between self-diagnosis output and 0 V) • Residual voltage: 1.0 V or less (at 50 mA sink current) 0.4 V or less (at 16 mA sink current) 					<p>PNP open-collector transistor</p> <ul style="list-style-type: none"> • Maximum source current: 50 mA • Applied voltage: 30 V DC or less (between self-diagnosis output and +V) • Residual voltage: 2.0 V or less (at 50 mA source current) 1.0 V or less (at 16 mA source current) 	
Output operation	ON under unstable sensing condition (restored automatically after 40 ms approx.), or if the sensing output is short-circuited (restored when short-circuit is rectified).						
Short-circuit protection	(For the remote sensitivity adjustment type, it turns ON for 40 ms approx. also after the remote sensitivity input is received.)						
Response time	0.6 ms or less (0.8 ms or less when the interference prevention function is used)						
Operation indicator	Red LED (lights up when the sensing output is ON)						
Stability indicator	<p>Green LED</p> <ul style="list-style-type: none"> 'RUN' mode: Lights up under stable light received condition or stable dark condition 'SET' mode: At the time of sensitivity setting, blinks twice when the difference between ON and OFF levels is greater than the hysteresis, but blinks 15 times when it is equal to or less than the hysteresis. Also blinks twice after the interference prevention is set 'SET' mode → When 'SIF' or 'RUN' mode is selected: Blinks from 0 to 5 times according to the sensitivity margin 						
Test input (emission halt) function	_____	Incorporated	_____	_____	_____		
External synchronization function	_____	Incorporated (Either gate or edge trigger is selectable)	_____	_____	_____		
Remote sensitivity setting function	_____	_____	Incorporated	_____	_____		
Remote sensitivity selection function	_____	_____	_____	Incorporated (Stores four sensitivities)	_____		
Sensitivity shift & limit sensitivity setting functions	Shifts the set sensitivity level						
Interference prevention function	Incorporated						
Timer function	ON-delay / OFF-delay timer (variable 0 to 5 sec.)	_____	ON-delay / OFF-delay timer (variable 0 to 5 sec.)				
Environmental resistance	Pollution degree	3 (Industrial environment)					
	Ambient temperature	- 10 to + 55 °C + 14 to + 131 °F (No dew condensation or icing allowed), Storage: - 20 to + 70 °C - 4 to + 158 °F					
	Ambient humidity	35 to 85 % RH, Storage: 35 to 85 % RH					
	EMC	EN 50081-2, EN 50082-2, EN 60947-5-2 (in combination with sensor heads SH-3 □.)					
	Voltage withstandability	1,000V AC for one min. between all supply terminals connected together and enclosure					
	Insulation resistance	20 M Ω , or more, with 250 V DC megger between all supply terminals connected together and enclosure					
	Vibration resistance	10 to 150 Hz frequency, 0.75 mm 0.030 in amplitude in X, Y and Z directions for two hours each					
Shock resistance	100 m/s ² acceleration (10 G approx.) in X, Y and Z directions for five times each						
Material	Enclosure: Heat-resistant ABS, Cover: Polycarbonate, Cable lock lever: PPS						
Cable	0.15 mm ² 6-core (SU-7 and SU-7P : 0.2 mm ² 4-core) cabtyre cable, 2 m 6.562 ft long						
Cable extension	Extension up to total 100 m 328.084 ft is possible with 0.3 mm ² , or more, cable.						
Weight	65 g approx.						
Accessories	MS-DIN-2 (Amplifier mounting bracket): 1 pc., SU-CT1 (Stripper): 1 pc.						

I/O CIRCUIT AND WIRING DIAGRAMS

SU-7 SU-7J Standard type • NPN output

I/O circuit diagram

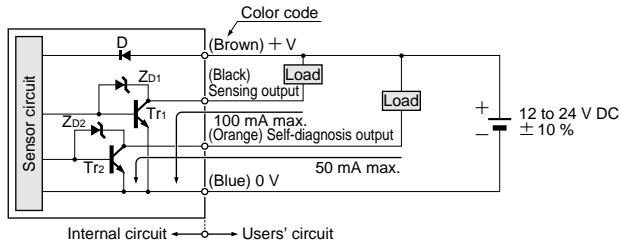

Symbols ... D: Reverse supply polarity protection diode
ZD1, ZD2: Surge absorption zener diode
Tr1, Tr2 : NPN output transistor

Wiring diagram

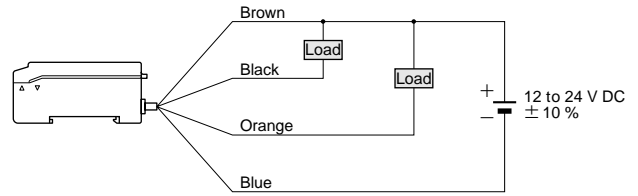

SU-75 External synchronization input type

I/O circuit diagram

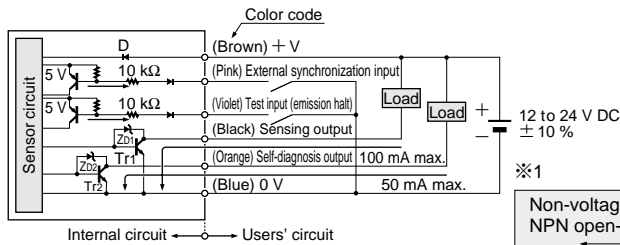

Symbols ... D: Reverse supply polarity protection diode
ZD1, ZD2: Surge absorption zener diode
Tr1, Tr2 : NPN output transistor

Wiring diagram

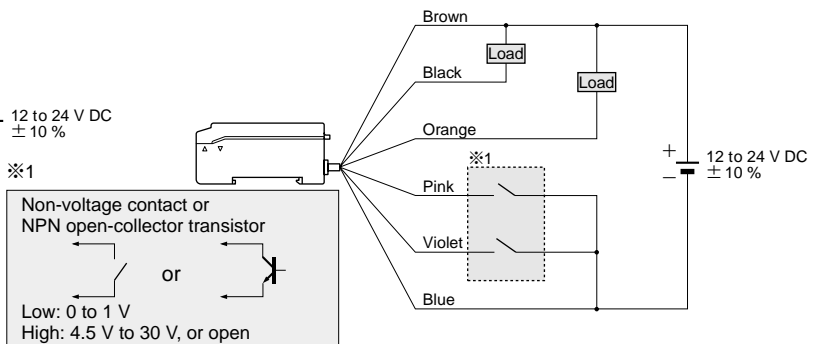

SU-77 Remote sensitivity setting type

I/O circuit diagram

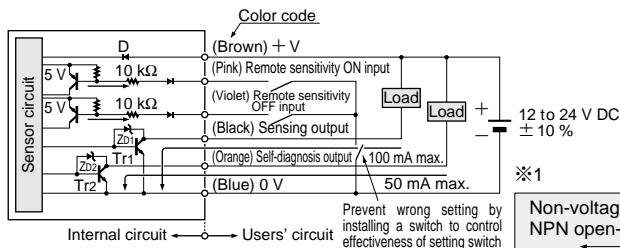

Symbols ... D: Reverse supply polarity protection diode
ZD1, ZD2: Surge absorption zener diode
Tr1, Tr2 : NPN output transistor

Wiring diagram

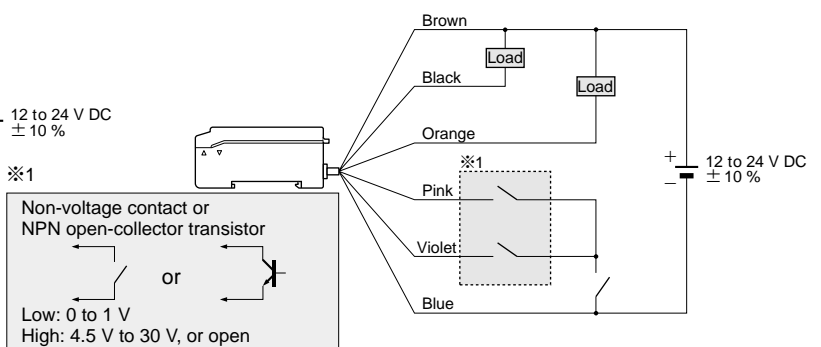

SU-79 Remote sensitivity selection type

I/O circuit diagram

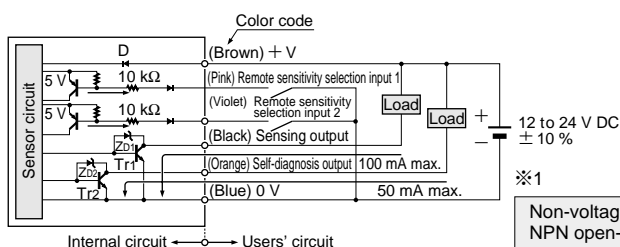

Symbols ... D: Reverse supply polarity protection diode
ZD1, ZD2: Surge absorption zener diode
Tr1, Tr2 : NPN output transistor

Wiring diagram

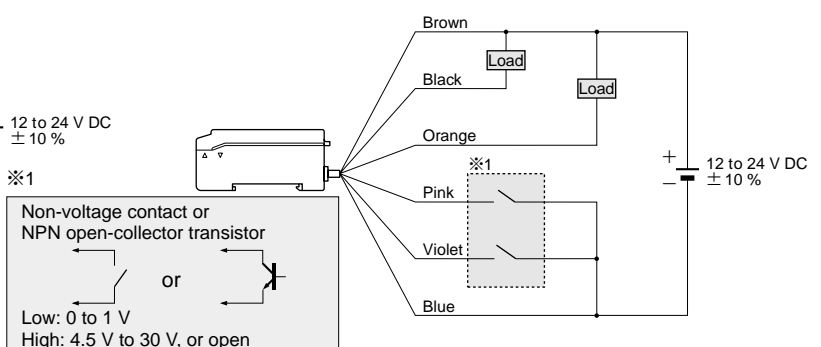

SU-7/SH

I/O CIRCUIT AND WIRING DIAGRAMS

SU-7P

Standard type • PNP output

I/O circuit diagram

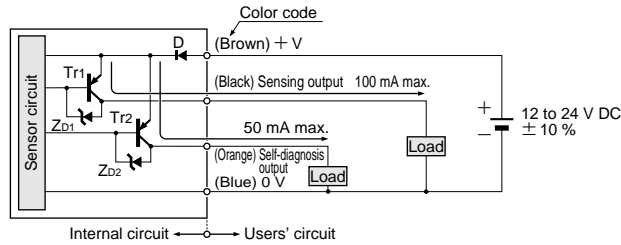

Symbols ... D: Reverse supply polarity protection diode
 ZD1, ZD2: Surge absorption zener diode
 Tr1, Tr2 : PNP output transistor

Wiring diagram

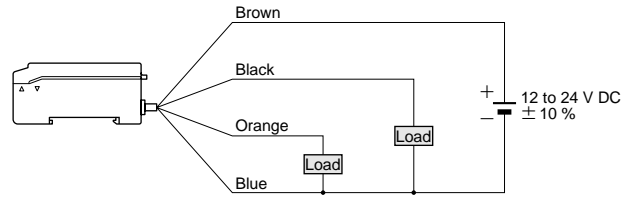

SENSING CHARACTERISTICS (TYPICAL)

SH-21 SH-21E

Thru-beam type

Parallel deviation

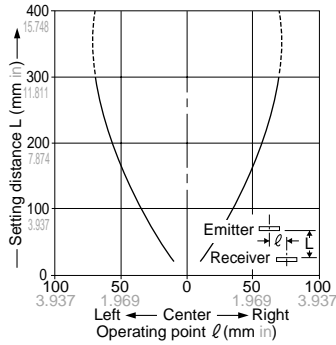

Angular deviation

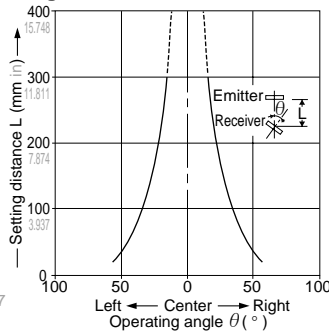

SH-31R

Thru-beam type

Parallel deviation

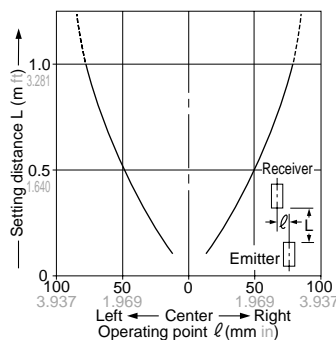

Angular deviation

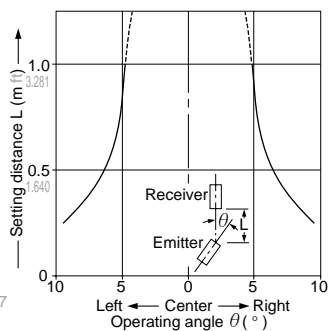

Parallel deviation with slit masks (0.5 X 3 mm 0.020 X 0.118 in)

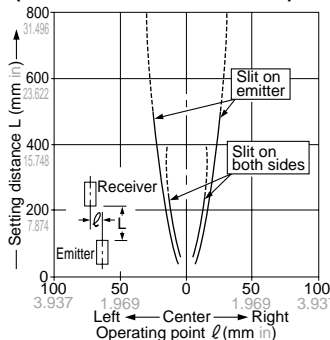

Parallel deviation with slit masks (1 X 3 mm 0.039 X 0.118 in)

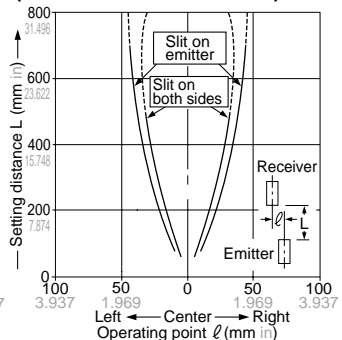

SH-31G

Thru-beam type

Parallel deviation

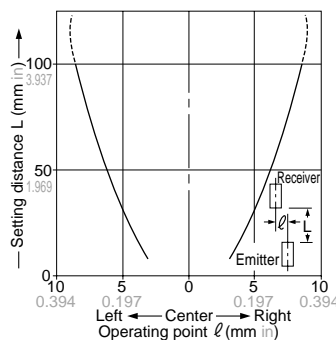

Angular deviation

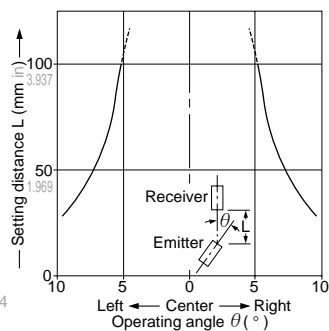

Parallel deviation with slit masks (0.5 X 3 mm 0.020 X 0.118 in)

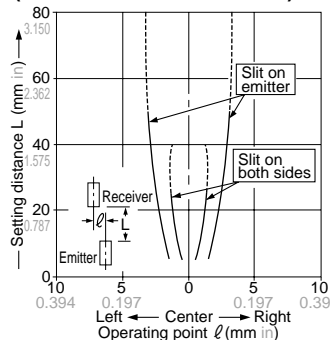

Parallel deviation with slit masks (1 X 3 mm 0.039 X 0.118 in)

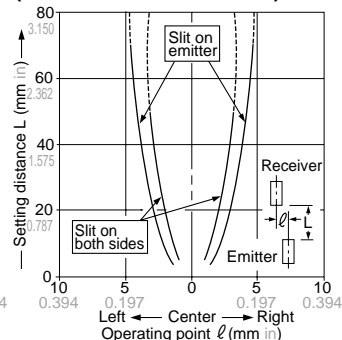

SENSING CHARACTERISTICS (TYPICAL)

SH-33R

Thru-beam type

Parallel deviation

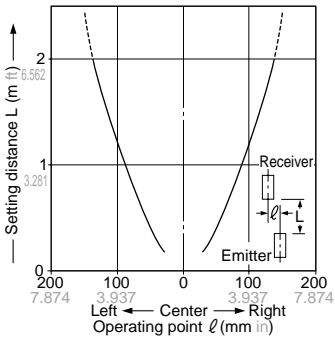

Angular deviation

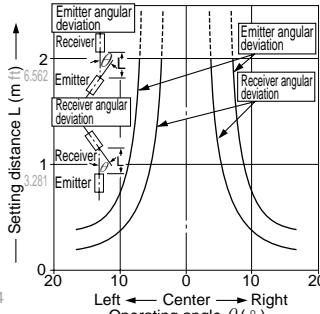

Parallel deviation with slit masks (0.5 X 3 mm 0.020 X 0.118 in)

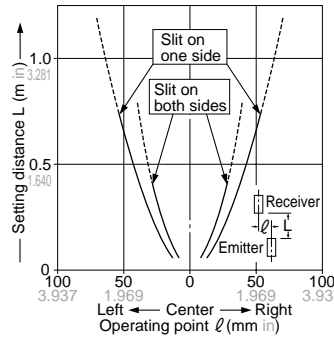

Parallel deviation with slit masks (1 X 3 mm 0.039 X 0.118 in)

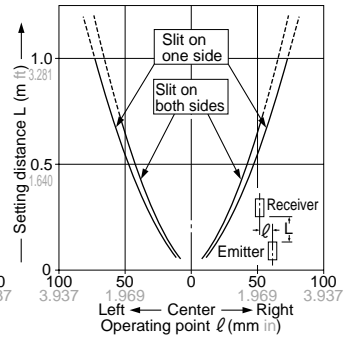

SH-22

Diffuse reflective type

Sensing field

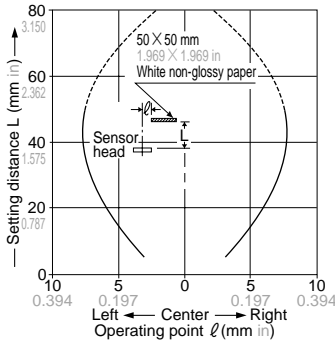

SH-32R

Diffuse reflective type

Sensing field

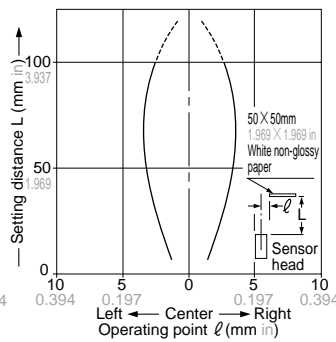

Correlation between sensing object size and sensing range

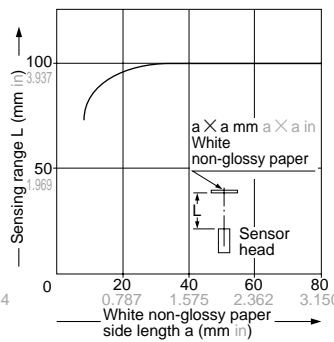

As the sensing object size becomes smaller than the standard size (white non-glossy paper 50 X 50 mm 1.969 X 1.969 in), the sensing range shortens, as shown in the left graph.

(For plotting the left graph, the sensitivity has been set such that a 50 X 50 mm 1.969 X 1.969 in white non-glossy paper is just detectable at a distance of 100 mm 3.937 in.)

SH-72

Glass substrate detection sensor

Sensing field

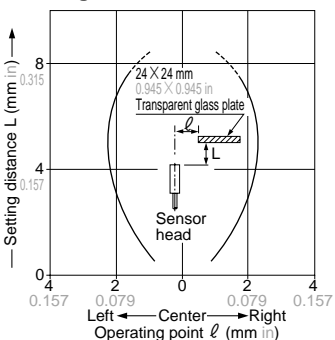

SH-82R

Mark sensor

Sensing field

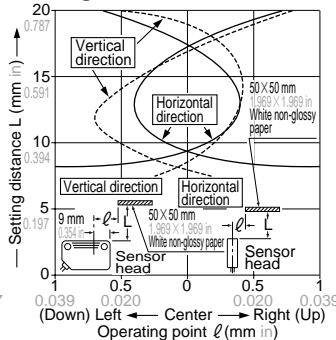

SH-82G

Mark sensor

Sensing field

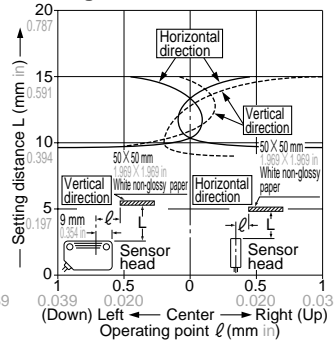

SH-84R

Mark sensor

Sensing field

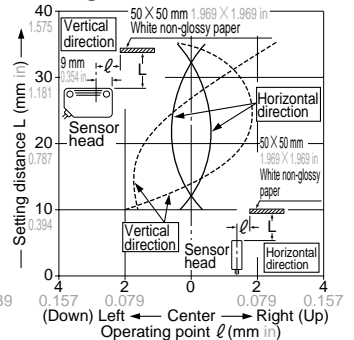

SH-61R

Chemical resistant type

Parallel deviation

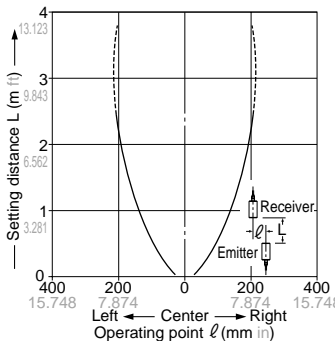

Angular deviation

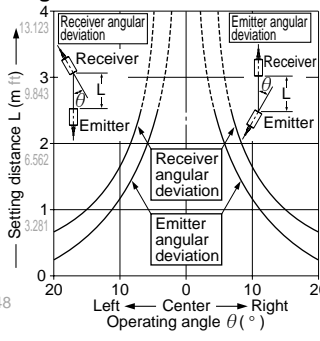

Sensing field with optional mounting bracket (MS-SH6-2)

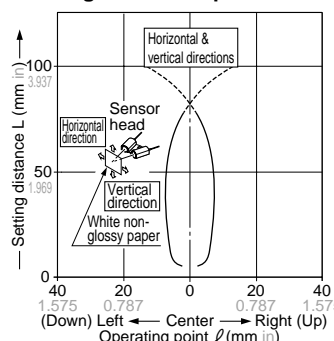

SU-7/SH

PRECAUTIONS FOR PROPER USE

Refer to p.1135~ for general precautions.

Sensor head

 This product is not a safety sensor. Its use is not intended or designed to protect life and prevent body injury or property damage from dangerous parts of machinery. It is a normal object detection sensor.

Always use the sensor head and the exclusive amplifier together as a set.

Mounting

Ultra-slim type

• With tapped screws <Side sensing>

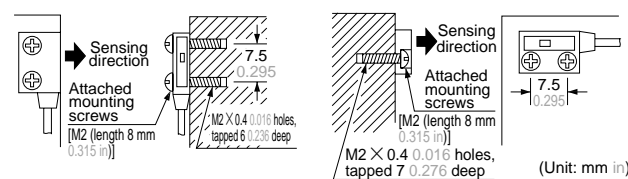

The tightening torque should be 0.14 N·m or less.

• With attached screws and nuts <Side sensing>

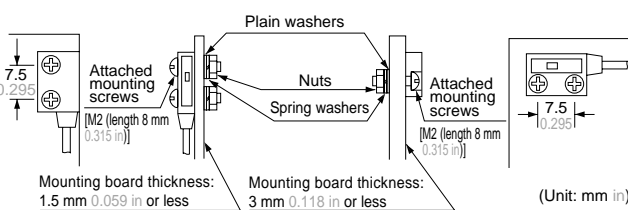

The tightening torque should be 0.14 N·m or less.

For ultra-small type, mark sensor & glass substrate detection sensor

• The tightening torque should be 0.29 N·m or less when mounting the sensor head with the screws.

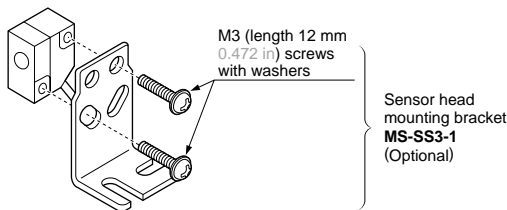

Chemical resistant type

• Use M3 screws to mount the sensor head with the attached sensor head mounting bracket.

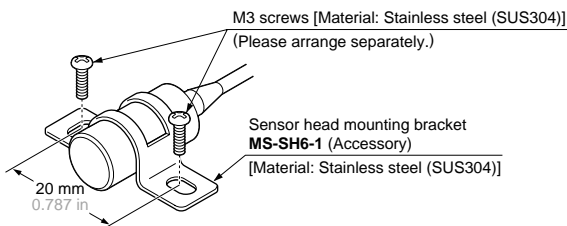

• Use M4 screws to assemble the sensor head with the optional sensor head mounting bracket **MS-SH6-2**, in order to form the convergent sensing mode.

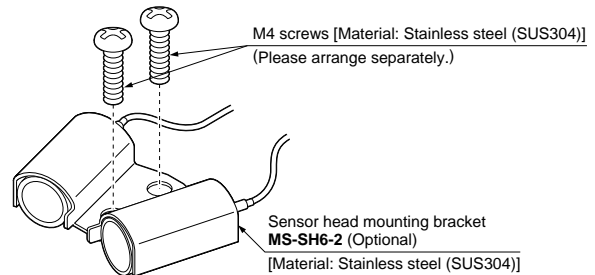

Wiring

• Trim the cable ends

The stripper **SU-CT1** helps you to cut the cable and peel the sheath off the cable.

To cut the cable or to strip the sheath, insert the cable into an appropriate hole as shown in the right figure and press the blade down.

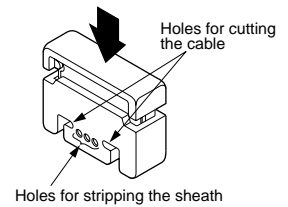

Note: The outer fluorine resin sheath of **SH-61R** cannot be peeled off with **SU-CT1**.

• If the attached sensor head cables need to be extended, use two single core shielded cables of at least equivalent quality.

If a joint terminal or connector is used for extension, refer to the figures below. (The shielded extension cable must be of $\phi 1.45$ mm $\phi 0.057$ in outer diameter.)

Connection with joint terminal

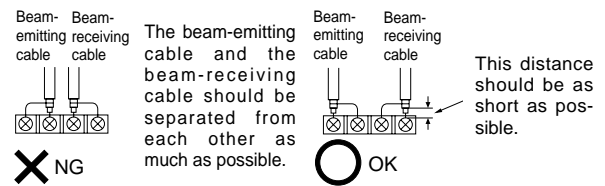

Connection with metal connector

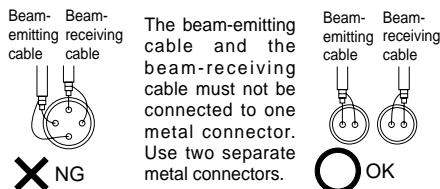

In case of chemical resistant type sensor head

• Do not use where it can be exposed to molten alkali metals (sodium, potassium, lithium, etc.), fluorine gas (F₂), ClF₃, OF₂ (including gaseous state), etc.

• In case of cable extension, the extended portion should be placed in an area where it is not exposed to chemicals.

PRECAUTIONS FOR PROPER USE

Refer to p.1135~ for general precautions.

Amplifier

Connection with the sensor head cable

Follow the procedure given below to connect the sensor heads. If the connection is not secure, the sensor will not work properly.

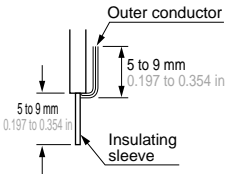
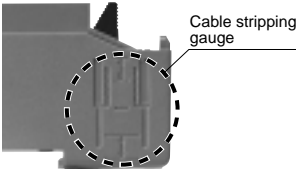
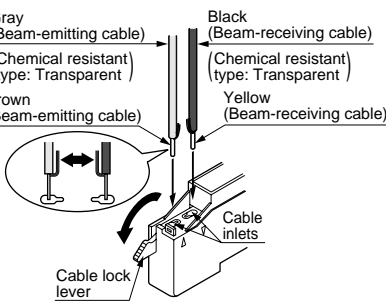
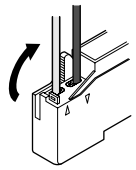
Step	Operation
①	Remove the cover.
②	<p>Trim the cable ends with the stripper SU-CT1 or a pair of nippers as shown on the right. Do not peel the insulating sleeve off the inner conductor.</p>  <p>A cable stripping gauge appears on the side of the SU-7 amplifier. Using this gauge, it is possible to obtain the given cable dimensions.</p> <div style="border: 1px solid black; padding: 5px; width: fit-content;"> <p>At the time of shipment, the inner conductor is stripped and cannot be used as it is. Make sure to trim the cables.</p> </div> 
③	<p>Snap the cable lock lever down and put the cables into the insertion holes of the amplifier with the outer shield wires facing each other. Cables should be inserted straight without bending.</p> 
④	<p>Pull the cable lock lever back to lock the cables.</p> 
⑤	Put the cover on the SU-7 amplifier.

Caution

- After locking, if the lock is released and the cable is removed, it can be locked again, as it is, only once. If the locking is repeated three times or more, repeat the process from Step ②. If the cables are locked and released repeatedly, note that the cable ends may break, resulting in a bad connection.
- If there is a shred of the cable left inside the cable inlet, remove it before connecting the sensor head cables. Turn the amplifier upside down, and tap it around the holes. If the shred still remains, peel the bottom seal off the amplifier, and drop it out. (The seal is reusable.)

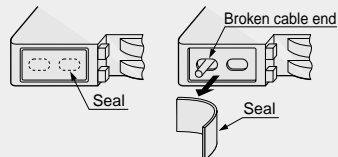

Mounting

How to mount the amplifier

- ① Fit the rear part of the amplifier on the attached amplifier mounting bracket (**MS-DIN-2**) or a 35 mm 1.378 in width DIN rail.
- ② Press down the front part of the amplifier on the amplifier mounting bracket (**MS-DIN-2**) or the DIN rail to fit it.

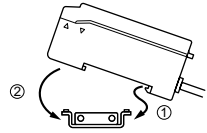

Attached amplifier mounting bracket or 35 mm 1.378 in width DIN rail

How to remove the amplifier

- ① Push the amplifier forward.
- ② Lift up the front part of the amplifier to remove it.

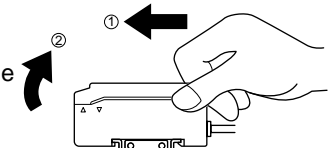

Wiring

- The self-diagnosis output does not incorporate a short-circuit protection circuit. Do not connect it directly to a power supply or a capacitive load.

Part description

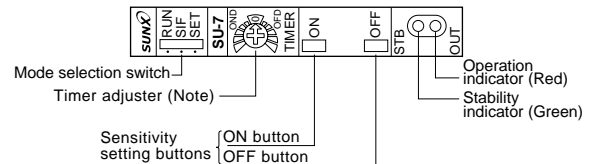

Note: In case of **SU-75**, this is the external synchronization selection switch.

SU-7/SH

PRECAUTIONS FOR PROPER USE

Refer to p.1135~ for general precautions.

Amplifier

Sensitivity setting

Normal sensitivity setting

Standard setting

The sensor recognizes the ON and OFF levels by your pressing of the buttons. The threshold level is automatically set at the middle between ON and OFF levels.

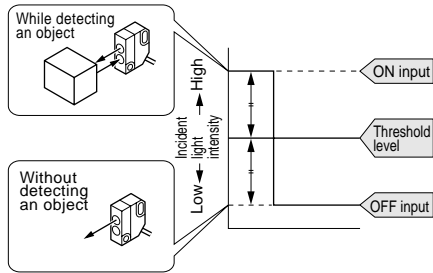

Setting procedure

<In case of sensing output ON with object present>

Step	Operation
①	Set the sensor heads within the sensing range.
②	Set the mode selection switch to 'SET'.
③	Press the ON button with the object present. (Release it within 3 sec.) <div style="display: flex; justify-content: space-around;"> Thru-beam type Diffuse reflective type </div>
④	When the ON level is recognized by the sensor, the stability indicator (green) blinks.
⑤	Press the OFF button with the object absent. (Release it within 3 sec.) <div style="display: flex; justify-content: space-around;"> Thru-beam type Diffuse reflective type </div>
⑥	<ul style="list-style-type: none"> The stability indicator blinks twice if the difference between the ON and OFF levels is sufficient for stable detection. The stability indicator blinks continuously if the difference between the ON and OFF levels is so small that stable detection is not possible. (Even though the sensitivity can be set and the sensor can work, the sensing will be ambiguous.)
⑦	Set the mode selection switch to 'RUN'. Now the sensitivity setting buttons (ON / OFF buttons) become ineffective. Even if the buttons are touched by mistake, the set sensitivity does not change.

<In case of sensing output ON with object absent>

In the above procedure, press the ON button with the object absent, and press the OFF button with the object present.

Maximum sensitivity setting

Full power setting

The maximum sensitivity is set. Take care that, in case of the diffuse reflective type, if a background object is present, the sensing output may turn ON even without the sensing object.

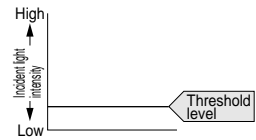

Setting procedure

Step	Operation
①	Make sure that the sensor receives no light.
②	Set the mode selection switch to 'SET'.
③	Press the 'ON' button in the Light-ON mode. Press the 'OFF' button in the Dark-ON mode.
④	When the input is recognized by the sensor, the stability indicator (green) blinks.
⑤	Press the 'OFF' button in the Light-ON mode. Press the 'ON' button in the Dark-ON mode.
⑥	When the input is recognized by the sensor, the stability indicator (green) blinks.
⑦	Set the mode selection switch to 'RUN'.

How to set sensitivity with external inputs

Remote sensitivity setting (SU-77 only)

Instead of pressing buttons, the sensitivity can be set with the remote sensitivity setting inputs.

(There is no external sensitivity shift mode.)

Setting procedure

The procedure is the same as for setting with sensitivity buttons, except that instead of pressing the buttons, the remote sensitivity setting input wire is short-circuited to 0 V. The mode selection switch is set to either the 'SET' or 'RUN' side.

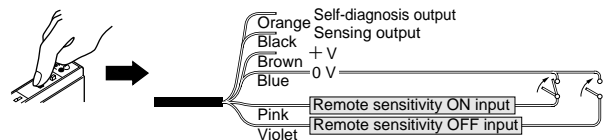

Time chart

The self-diagnosis output stays ON for approx. 40 ms after ON input or OFF input is recognized by the sensor.

(If the difference between the ON and OFF levels (the difference between incident light levels) is so small that stable detection is not possible, it does not turn ON.)

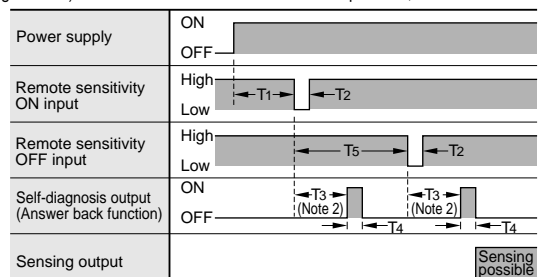

T1 ≥ 1,000 ms, 3,000 ms < T2 ≤ 5 ms, T3 ≈ 310 ms, T4 ≈ 40 ms, T5 ≥ 500 ms

Notes: 1) Signal condition ... Low: 0 to 1 V, High: 4.5 to 30 V, or open Input impedance: 10 kΩ

2) Do not move the object, etc., or change the incident light intensity during T3.

PRECAUTIONS FOR PROPER USE

Refer to p.1135~ for general precautions.

Amplifier

● Sensitivity for detecting minute differences

Limit sensitivity setting

Setting for minute detection is possible just by pressing a button once without the object being present.

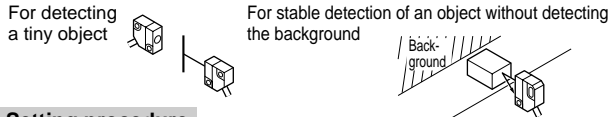

Setting procedure

Step	Operation
	Set the sensor without an object and under stable light receiving condition.
	<div style="display: flex; justify-content: space-around;"> <div style="text-align: center;"> Thru-beam type </div> <div style="text-align: center;"> Diffuse reflective type </div> <div style="text-align: center;"> Mark sensor </div> </div>
①	
②	Set the mode selection switch to 'SET'.
③	By pressing either ON or OFF button for 3 sec. or more, the threshold level is set 15% either lower or higher than the object absent level as shown in the right figure. (Please note that the output operation cannot be reversed.) For example, press the ON button for detecting a tiny object.
④	Set the mode selection switch to 'RUN'.

● For applications in which beam intensity fluctuates

Sensitivity shift

If the incident light is stable in either the object present or object absent state, by shifting the threshold level towards this state, stable sensing is possible even if the incident light is unstable in the other state. The setting level is the same as for limit sensitivity setting. However, since the operating level is shifted after the normal sensitivity setting, output operation is selectable.

Setting procedure

Step	Operation
①	Set the sensitivity by following the standard setting procedure. (If the sensitivity margin is small, sensitivity shift cannot be done.)
②	Set the mode selection switch to 'SIF'.
③	Press the sensitivity setting button which was pressed in the stable light received condition. For example, for a diffuse reflective type sensor, in case a background object is present, press the button which was pressed with only the background object being sensed.
④	Set the mode selection switch to 'RUN'.

Remote sensitivity selection function (SU-79 only)

• SU-79 can store four channels of sensitivity levels, which can be selected as per your requirement.

Sensitivity storage

Step	Operation															
①	Set the mode selection switch to 'SET'.															
	Designate the channel that is to store the sensitivity by making the remote sensitivity selection inputs 1 and 2 suitably High or Low.															
	Wiring 															
②	Signal condition Low: 0 to 1 V High: 4.5 to 30 V, or open Input impedance: 10 kΩ															
	Channel selection <table border="1"> <thead> <tr> <th>Channel</th> <th>Remote sensitivity selection input 1</th> <th>Remote sensitivity selection input 2</th> </tr> </thead> <tbody> <tr> <td>1</td> <td>Low</td> <td>Low</td> </tr> <tr> <td>2</td> <td>Low</td> <td>High</td> </tr> <tr> <td>3</td> <td>High</td> <td>Low</td> </tr> <tr> <td>4</td> <td>High</td> <td>High</td> </tr> </tbody> </table>	Channel	Remote sensitivity selection input 1	Remote sensitivity selection input 2	1	Low	Low	2	Low	High	3	High	Low	4	High	High
Channel	Remote sensitivity selection input 1	Remote sensitivity selection input 2														
1	Low	Low														
2	Low	High														
3	High	Low														
4	High	High														
③	Set the sensitivity.															
④	Designate another channel and set the sensitivity again.															
⑤	Set the mode selection switch to 'RUN'.															

Sensitivity selection

Step	Operation
①	Set the mode selection switch to 'RUN'.
②	Designate the channel you wish to select by making the remote sensitivity selection inputs 1 and 2 suitably High or Low.

Stability margin indication function

• After setting the sensitivity, the margin of stability can be determined. When the mode selection switch is changed from 'SET' to 'SIF' or 'RUN', the stability indicator (green) blinks. The number of blinks indicates the margin of stability.

Number of blinks	0	1	2	3	4	5
Margin (%) (Margin with respect to threshold level)	Under 15	15 to 30	30 to 45	45 to 60	60 to 75	Over 75

SU-7/SH

PRECAUTIONS FOR PROPER USE

Refer to p.1135~ for general precautions.

Amplifier

External synchronization function (SU-75 only)

- The external synchronization function can be used to control the timing of sensing. Edge trigger or gate trigger are available.

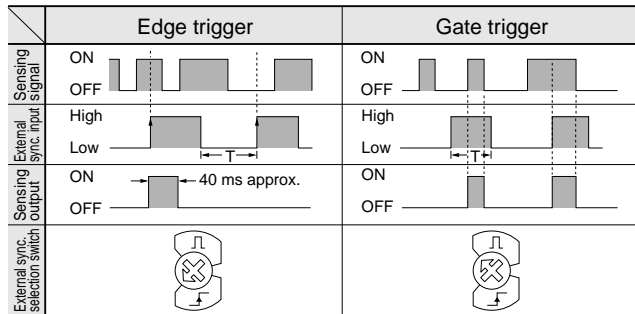

$T \geq 0.6$ ms ($T \geq 0.8$ ms when the interference prevention function is used)
 Note: The external synchronization selection switch must be turned fully clockwise or counterclockwise.

Test input (emission halt) function (SU-75 only)

- When the test input (emission halt input) (violet) is short-circuited to 0 V (Low), the beam emission is halted. This function is useful for a start-up test since the sensing output can be made ON / OFF without the sensing object. Short-circuit to 0 V and open the input, repeatedly. If the sensing output follows this operation, the sensor is working well, else not.

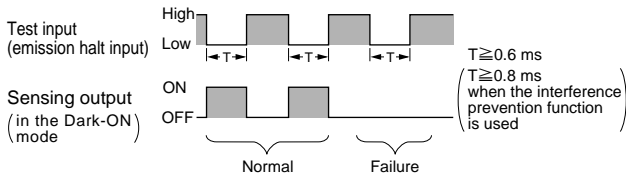

Timer function (Except for SU-75)

- Every SU-7 series amplifier (except for SU-75) is incorporated with a variable ON / OFF delay timer for 0 to 5 sec.

ON-delay

As only longer signals are extracted, this function is useful for detecting if a line is clogged, or for sensing only objects taking a long time to travel.

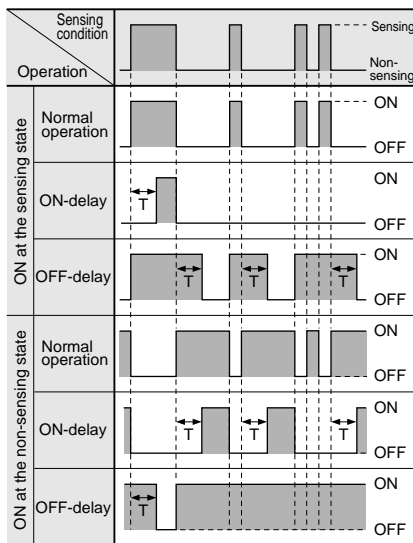

Timer period: T = 0 to 5 sec.

OFF-delay

Since the output signal is extended for a fixed time interval, this function is useful if the output signal is so short that the connected device cannot respond.

• Timer period setting

Adjust the time duration of ON or OFF delay by turning the timer adjuster.

Note: Adjust the timer under 'SET' mode. Adjustment is not allowed in 'SIF' or 'RUN' mode.

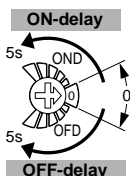

Interference prevention function

- Every SU-7 amplifier is incorporated with an interference prevention function. By setting different emission frequencies, sensor heads can be mounted close together (up to 2 units.).

Setting

Step	Operation
①	Set the mode selection switch to 'SET'.
②	Press both 'ON' and 'OFF' buttons <u>simultaneously</u> for 2 sec. or more. The stability indicator (green) blinks.
③	Press 'ON' button. (The stability indicator blinks twice.) [Response time: 0.6 ms or less (Note 1)]
④	Set the mode selection switch to 'RUN'. (This completes the setting for one amplifier.)
⑤	Apply steps ① and ② to the second amplifier.
⑥	Press the 'OFF' button. (The stability indicator blinks twice.) [Response time: 0.8 ms or less (Note 1)]
⑦	Set the mode selection switch to 'RUN'. (This completes the setting.)

Cancellation

Step	Operation
①	Press both 'ON' and 'OFF' buttons <u>simultaneously</u> for 2 sec. or more. The stability indicator (green) blinks.
②	Press both 'ON' and 'OFF' buttons simultaneously again. (The stability indicator blinks twice.)

- Notes: 1) The interference prevention function increases the hysteresis and the response time. After it is set, make sure to check the operation.
 2) When the interference prevention function is used with thru-beam type sensors, set the sensitivity by standard setting, limit setting of shift setting.

PRECAUTIONS FOR PROPER USE

Refer to p.1135~ for general precautions.

Amplifier

Self-diagnosis function

- The sensor checks the incident light intensity, and if it is reduced due to dirt or dust, or beam misalignment, an output is generated.

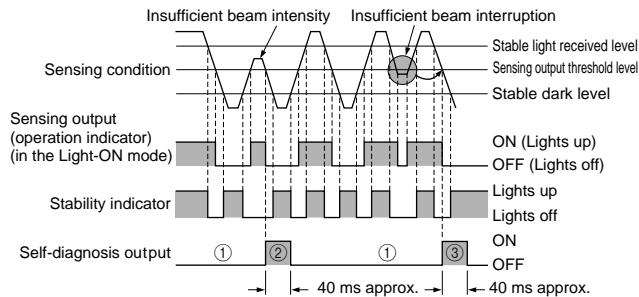

- The self-diagnosis output transistor stays in the 'OFF' state during stable sensing.
- When the sensing output changes, if the incident light intensity does not reach the stable light received level or the stable dark level, the self-diagnosis output becomes ON. It is automatically restored after 40 ms approx. Further, the self-diagnosis output changes state when the sensing output changes from Light to Dark state. (It is not affected by the output operation of the sensing) output.
- In case of insufficient beam interruption, there will be a time lag before the self-diagnosis output turns ON.

Others

- Do not use during the initial transient time (0.5 sec.) after the power supply is switched on.

SU-7/SH

DIMENSIONS (Unit: mm in) The CAD data in the dimensions can be downloaded from the SUNX website: <http://www.sunx.co.jp/>

SU-7 Amplifier

Assembly dimensions with attached amplifier mounting bracket

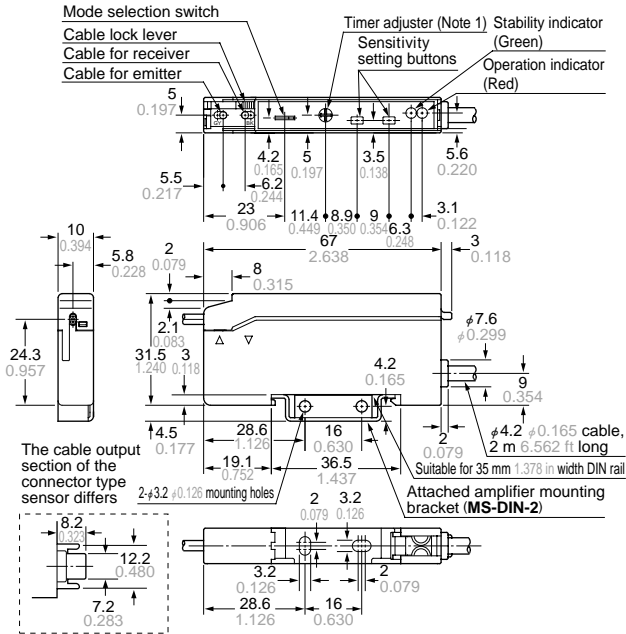

Notes: 1) It is the external synchronization selection switch on SU-75.
2) The top view is shown without the cover or the sensor head cable.

MS-DIN-2 Amplifier mounting bracket (Accessory for amplifier)

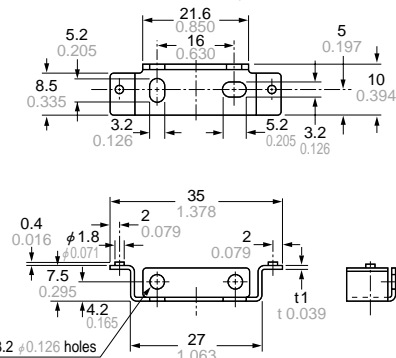

SH-21E Sensor head

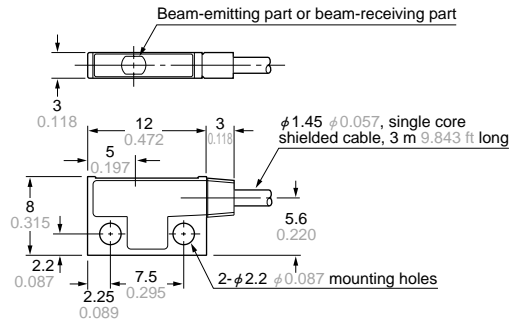

Note: The above dimensions are identical for the emitter and the receiver.

SH-21 Sensor head

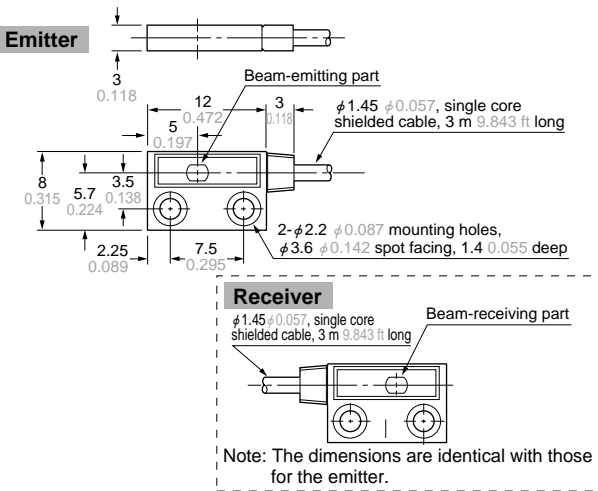

SH-22 Sensor head

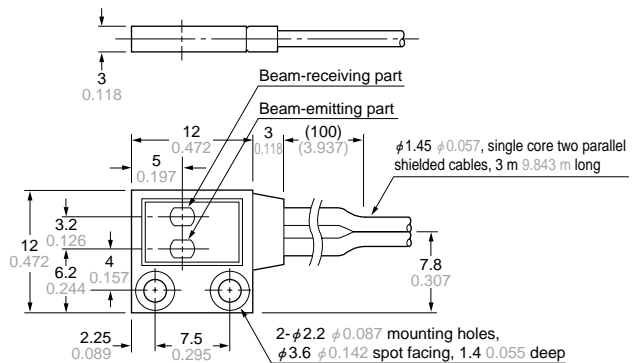

SH-31R SH-31G SH-33R Sensor head

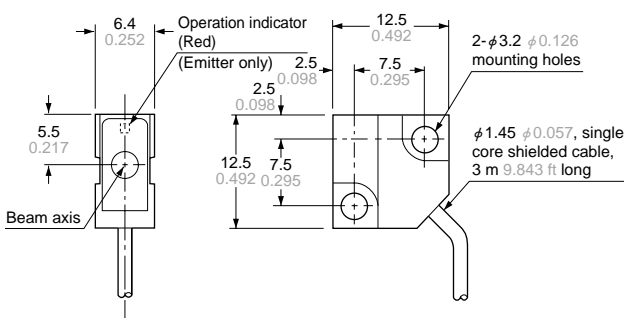

SH-32R Sensor head

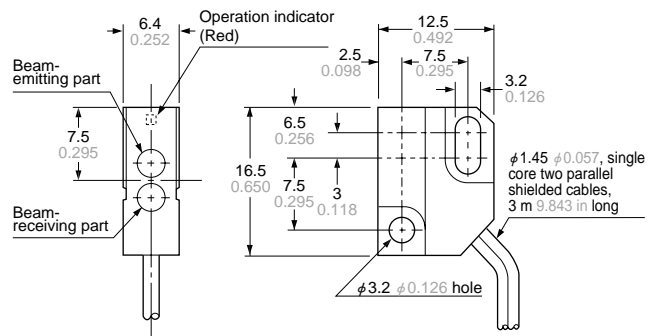

DIMENSIONS (Unit: mm in) The CAD data in the dimensions can be downloaded from the SUNX website: <http://www.sunx.co.jp/>

SH-82R SH-82G SH-84R Sensor head

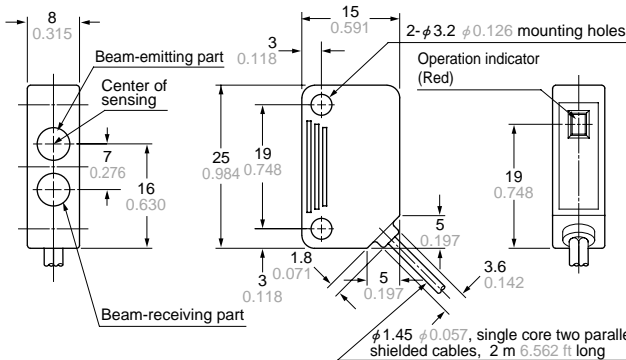

SU-CT1 Stripper (Accessory for amplifier)

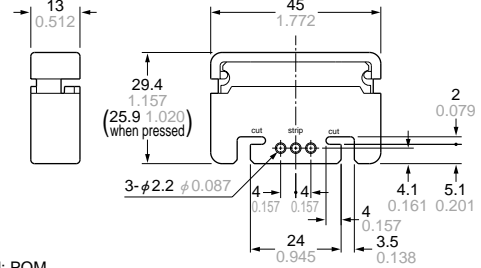

Material: POM

SH-72 Sensor head

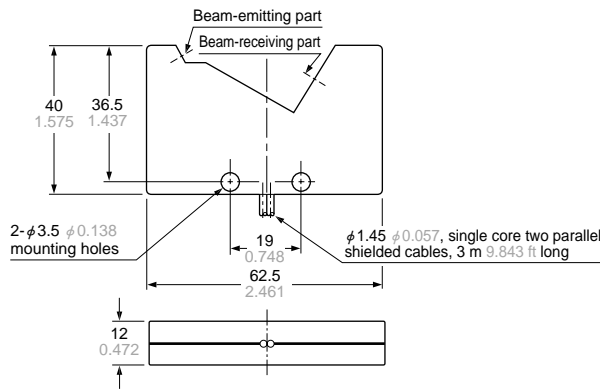

MS-DS-1 Sensor head mounting bracket (Optional)

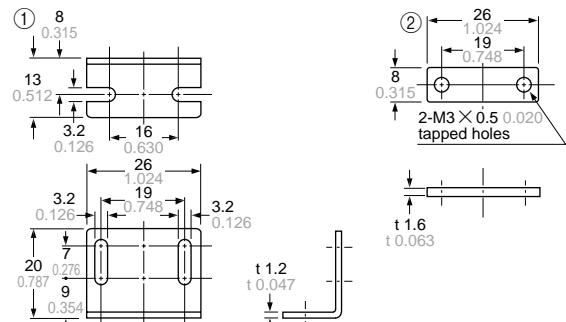

Material: Cold rolled carbon steel (SPCC) (Uni-chrome plated)

Two M3 (length 14 mm 0.551 in) screws with washers are attached.

SH-61R Sensor head

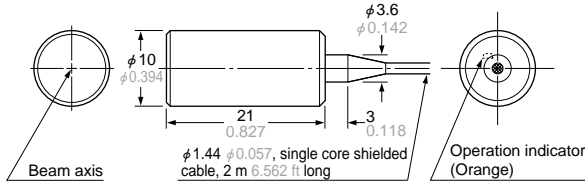

MS-SS3-1 Sensor head mounting bracket (Optional)

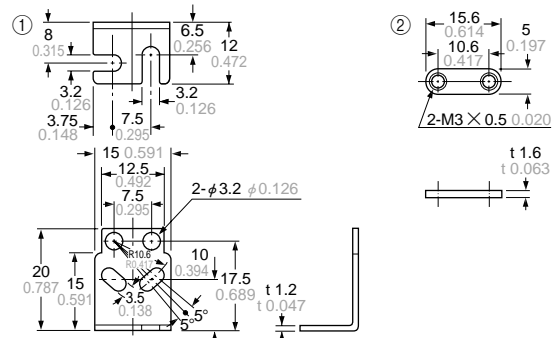

Material: Cold rolled carbon steel (SPCC) (Uni-chrome plated)

Two M3 (length 12 mm 0.472 in) screws with washers are attached.

MS-SH6-1 Sensor head mounting bracket (Accessory for SH-61R)

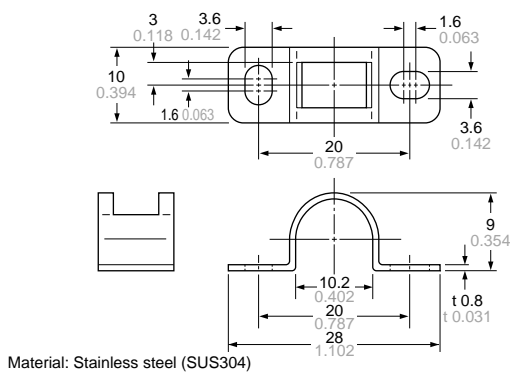

Material: Stainless steel (SUS304)

MS-SH6-2 Sensor head mounting bracket (Optional)

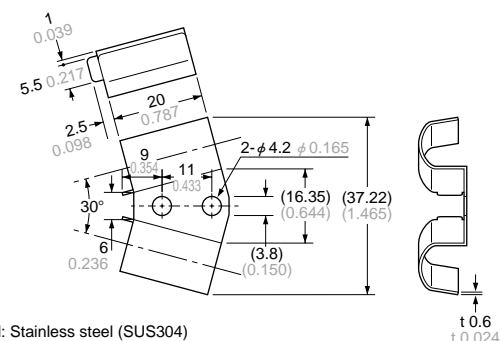

Material: Stainless steel (SUS304)