

LA-T SERIES

Orders accepted till September, 2003
Production to be discontinued from
April, 2004

Winding Wire Granular Flaw Detector



**Fast and reliable
minute granular flaw
detection in winding
wires**

Slim

LA-T11 is just 16 mm 0.630 in wide. It is mountable even on winding wire lines having a 10 mm 0.394 in pitch.

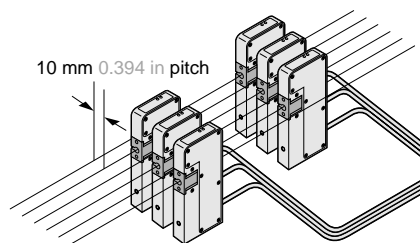

Reliable detection of 10 μm 0.394 mil high flaw

A 10 μm 0.394 mil high flaw (grain or pit) can be reliably detected at a high line speed of 500 m/min.

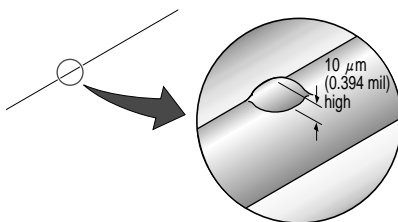

Suitable for 2,500 m/min. high line speed

It is suitable for a wide range of lines from a low speed of 5 m/min. to a high speed of 2,500 m/min.

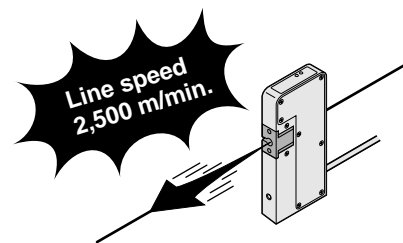

Automatic check of dust and dirt

In case small amount of dust or dirt sticks to the sensing surface, the controller automatically adjusts the sensitivity. In case the dust and dirt reduces the light intensity substantially, the alarm indicator lights up in orange. Further, the cleaning or replacement of a dirty glass filter is also simple.

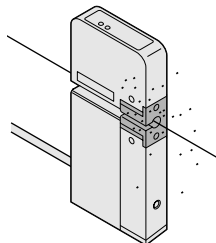

ORDER GUIDE

Sensor head

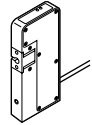
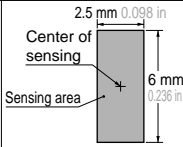
Appearance	Sensing area	Measurable wire diameter	Model No.
		$\phi 0.01$ to $\phi 1$ mm $\phi 0.0004$ to $\phi 0.039$ in	LA-T11

Make sure to use the sensor head (LA-T11) and the controller (LA-TC12) as a set.

Controller

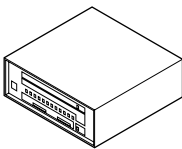
Appearance	Model No.	Output
	LA-TC12	NPN open-collector transistor

Accessories

• **LA-TH**
(Shading food, imbedded within the sensor head)

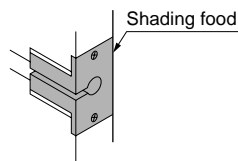

• **LA-TF**
(Glass filter, imbedded within the sensor head)

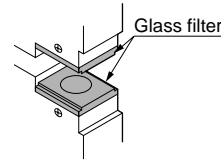

OPTIONS

Designation	Model No.	Description
Extension cable	LG-CC5	Length: 5 m 16.404 ft Weight: 300 g approx.
	LG-CC10	Length: 10 m 32.808 ft Weight: 600 g approx.

Extension cable

- LG-CC5
- LG-CC10

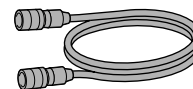

Max. 12 sensor heads connectable

Max. 12 sensor heads are connectable to one controller.

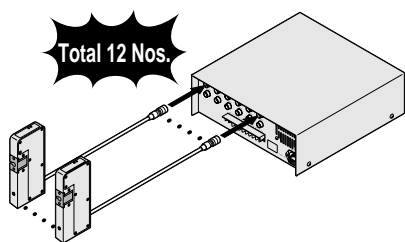

Easy Setting of Minimum Sensing Object

As the sensitivity can be set in the range 10 to 100 μm (0.394 to 3.937 mil) (10 steps of 10 μm 0.394 mil pitch), setting can be made according to the smallest object to be sensed.

Sensitivity setting switch

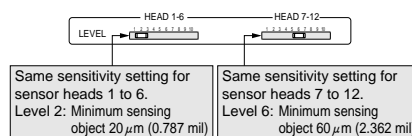

Monitoring sensor head conditions

It is possible to know, at one glance, the operating condition and the alarm output of each sensor head since they are all displayed on the controller. Further, the sensor heads which are used can be selected by the sensor head selection switch.

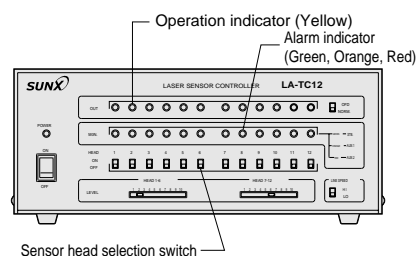

Principle of Detection

In a normal outer diameter measurement equipment, the absolute value of the wire diameter is measured, which takes time. Consequently, if the line speed is high, small grains or pits cannot be detected.

The **LA-T** series employs a differential detection technique. In this technique, a parallel beam emitted from a semiconductor laser is received by two receiving elements, and the difference in the light received is detected. Hence minute differences can be detected even at high line speeds.

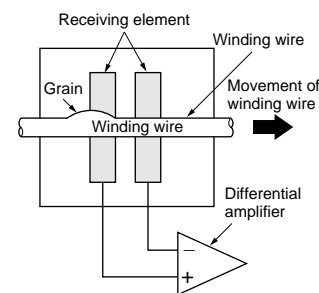

SPECIFICATIONS

Sensor head

Model No.	LA-T11	
Item	LA-TC12	
Applicable controller	LA-TC12	
Sensing area	2.5 × 6 mm 0.098 × 0.236 in (Note 1)	
Sensible object	Winding wire flaws	
Measurable wire diameter	φ 0.01 to φ 1 mm φ 0.0004 to φ 0.039 in	
Permitted wire swing amplitude (Note 1)	± 1.2 mm ± 0.047 in (sensing width direction) ± 2.9 mm ± 0.114 in (beam axis direction)	
Min. sensing object (Note 2)	Granular flaw of height 10 ± 5 μm 0.394 ± 0.197 mil (However, length: 200 μm 7.874 mil or more, line speed: 500 m/min. or less)	
Wire speed	5 m/min. (length of granular flaw: 50 μm 1.969 mil or more) to 2,500 m/min. (length of granular flaw: 250 μm 9.843 mil or more)	
Warm-up time	15 min. approx.	
Power indicator	Orange LED (lights up when the power is ON)	
Operation indicator	Yellow LED (lights up when granular flaw is detected)	
Alarm indicator	3-color LED (Green: lights up under stable light condition Orange: lights up when glass filter is defective Red: lights up when sensor head is malfunction)	
Environmental resistance	Ambient temperature	+ 5 to + 50 °C + 41 to + 122 °F (No dew condensation), Storage: + 10 to + 60 °C + 14 to + 140 °F
	Ambient humidity	35 to 85 % RH, Storage: 35 to 85 % RH
	Ambient illuminance	Sunlight: 10,000 lx at the light-receiving face, Incandescent light: 3,000 lx at the light-receiving face
	Noise immunity	Power line: 120 Vp, 10 ms cycle, and 0.5 μs pulse width; Radiation: 300 Vp, 10 ms cycle, and 0.5 μs pulse width (with noise simulator)
	Insulation resistance	20 MΩ, or more, with 250 V DC megger between all supply terminals connected together and enclosure
Vibration resistance	10 to 55 Hz frequency, 0.35 mm 0.014 in amplitude in X, Y and Z directions for two hours each	
Emitting element	Infrared semiconductor laser Class 1 (Maximum output: 0.18 mW or less, Peak emission wavelength: 780 nm 0.030 mil)	
Enclosure earthing	Capacitor earth	
Material	Enclosure: Die-cast aluminum, Window opening: Glass	
Cable	0.38 mm ² 12-core composite cable, 4 m 13.123 ft long (with a connector at the end)	
Cable extension	Extension up to total 14 m 45.932 ft is possible with exclusive cable. (Note 3)	
Weight	420 g approx.	

Notes: 1) Please note that an error in the sensing of the granular flaw is produced if the winding wire swings away from the center of sensing in the sensing width direction. Further, take care that this error due to the wire swing increases with the thickness of the wire.

Sensor head

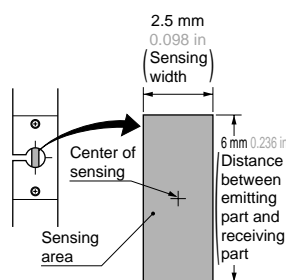

(Example)

• In case of φ 0.1 mm φ 0.004 in winding wire

Wire swing amplitude (Sensing width direction)	± 0.5 mm (± 0.020 in)	± 1.2 mm (± 0.047 in)
Sensing error	± 5 μm (± 0.197 mil)	± 15 μm (± 0.591 mil)

• In case of φ 0.5 mm φ 0.020 in winding wire

Wire swing amplitude (Sensing width direction)	± 0.1 mm (± 0.004 in)	± 0.5 mm (± 0.020 in)	± 1 mm (± 0.039 in)
Sensing error	± 5 μm (± 0.197 mil)	± 15 μm (± 0.591 mil)	± 30 μm (± 1.181 mil)

※ The actual error is the sum of the error given in the above table and the error for the smallest sensing object which is set by the sensitivity setting switch on the controller.

2) The smallest sensing object is as given below. Further, note that, depending upon the sensing conditions, an error exists in the sensing of the smallest object.



3) In case the cable is required to be extended, please use the optional extension cable (having connector on both sides).

SPECIFICATIONS

Controller

Item	Model No.	LA-TC12
Applicable sensor head		LA-T11 (Max. 12 sensor heads are connectable)
Supply voltage		100 V AC \pm 10 % 50/60 Hz
Power consumption		150 VA or less (when connecting 12 LA-T11 sensor heads)
Common power supply for sensor heads		12 V DC, 150 mA max.
Sensing output (OUT 1 to OUT 12)		NPN open-collector transistor <ul style="list-style-type: none"> • Maximum sink current: 100mA • Applied voltage: 30 V DC or less (between sensing output and GND) • Residual voltage: 1.5 V or less (at 100 mA sink current) 0.4 V or less (at 16 mA sink current)
	Output operation	ON upon sensing
	Short-circuit protection	Incorporated
Alarm output (ALM. 1, ALM. 2)		NPN open-collector transistor <ul style="list-style-type: none"> • Maximum sink current: 100 mA • Applied voltage: 30 V DC or less (between alarm output and GND) • Residual voltage: 1.5 V or less (at 100 mA sink current) 0.4 V or less (at 16 mA sink current)
	Output operation	ALM. 1: OFF when glass filter of even one of the used sensor heads is defective ALM. 2: OFF when even one of the used sensor heads is malfunction (cable disconnection, laser deterioration or sensing output short-circuit)
	Short-circuit protection	—
Response time		5 μ s or less (when line speed switch is set to HI), 25 μ s or less (when line speed switch is set to LO)
Warm-up time		15 min. approx.
Power indicator		Orange LED (lights up when the power is ON)
Operation indicator		Yellow LED (lights up when the sensing output is ON, lights up for 3 sec., 2 sec. after power supply is switched on)
Alarm indicator		3-color LED <ul style="list-style-type: none"> Green: lights up under stable light received condition Orange: lights up when ALM. 1 is OFF Red: lights up when ALM. 2 is OFF (2 sec. after the power supply is switched on, the LED lights up) in red, orange, green, in turn, at 1 sec. interval.
Timer function		2 ms approx. fixed OFF-delay timer, switchable either effective or ineffective (common for all channels)
Environmental resistance	Ambient temperature	+ 5 to + 50 °C + 41 to + 122 °F (No dew condensation), Storage: - 10 to + 60 °C + 14 to + 140 °F
	Ambient humidity	35 to 85 % RH, Storage: 35 to 85 % RH
	Noise immunity	Power line: 1,000 Vp, 10 ms cycle, and 0.5 μ s pulse width; Radiation: 300 Vp, 10 ms cycle, and 0.5 μ s pulse width (with noise simulator)
	Insulation resistance	20 M Ω , or more, with 500 V DC megger between all supply terminals connected together and enclosure
Enclosure earthing		Capacitor earth
Material		Enclosure: Electrolytic zinc-coated steel sheet (SECC)
Weight		3.6 kg approx.
Accessories		Power supply cable (3 m 9.843 ft): 1 cable., Converter plug (3 pin \rightarrow 2 pin): 1 pc.

Metal-sheet Double-feed Detection

GD

Hot Melt/Glue Detection

TH

Wire Flaw Detection

LA-T

Water Detection

EZ-10

OUTPUT CIRCUIT

Output circuit diagram

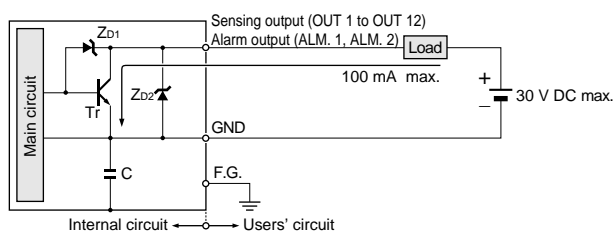

Symbols ... ZD1, ZD2: Surge absorption zener diode
Tr: NPN output transistor
C: Capacitor (1,000 pF)

Terminal arrangement of output signal terminal block

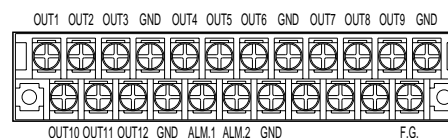

OUT 1 to OUT 12: Sensing output of each sensor head
ALM. 1, ALM. 2: Alarm output
GND: Ground for output
F.G.: Frame ground

PRECAUTIONS FOR PROPER USE

- This product is not a safety sensor. Its use is not intended or designed to protect life and prevent body injury or property damage from dangerous parts of machinery. It is a normal object detection sensor.
- Although this product corresponds to a Class 1 laser product, it is dangerous to see the laser beam which has been passed through a viewing optical system such as a lens, etc. Hence, please avoid this.
- This product has been designed to meet the specifications when the sensor head and the dedicated controller are used in combination. If it is used in any other combination, not only the specifications may not be met, but it may also be a cause for malfunction or breakdown. Hence, please ensure to use this product along with the optional dedicated controller.
- Do not use during the warm-up time (15 min. approx.) after the power supply is switched on.



Safety measures for laser beam products

- The safety standard IEC Publication 825 specifies the use of laser beam products. Please read it carefully before using the laser beam sensor.

Safety standards for laser beam products

- A laser beam can harm human being's eyes, skin, etc., because of its high energy density. IEC and JIS have classified laser products according to the degree of hazard and the stipulated safety requirements. The **LA-T** series is classified as Class 1 laser product.

Class	Degree of danger
Class 1	Intrinsically safe design.
Class 2	Visible and low power (wavelength 400 to 700 nm 0.016 to 0.028 mil). Eyes react instinctively to laser beam and protect themselves.
Class 3A	Dangerous if eyes are exposed to laser beam through optical means. Visible beam should be 5 mW or less. Invisible beam should not exceed 5 times the Class 1 power.
Class 3B	Dangerous if eyes are exposed to laser beam directly. Unfocused, pulsed laser radiation 0.5 W or less can be observed by means of diffuse reflection.
Class 4	Too intense. Even diffuse reflection is possibly dangerous. It can burn the skin or cause a fire.

Mounting

- When the sensor head is mounted on a mounting base, etc., determine the position at which the winding wire comes at the center of the sensing area and then mount the sensor with M5 screws. The tightening torque should be 1.2 N·m or less.

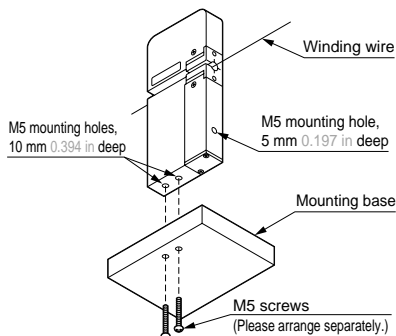

Connection of sensor heads

- Max. 12 sensor heads are connectable to one controller.

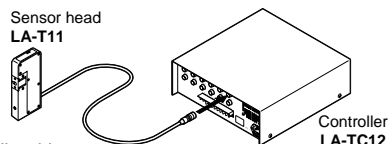

Note: Do not supply power while wiring.

Functional description

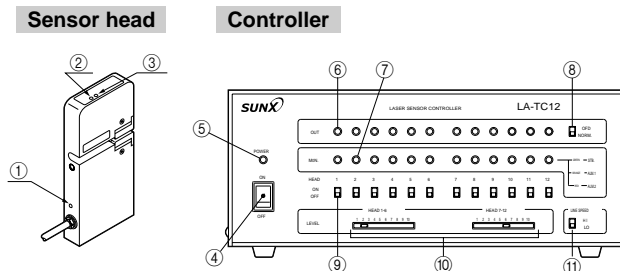

	Description	Function
Sensor head	① Power indicator (Orange LED)	Lights up when the power is ON.
	② Operation indicator (Yellow LED)	Lights up when granular flaw is sensed.
	③ Alarm indicator (3-color LED)	(Green) Lights up under stable light received condition. (Orange) Lights up when glass filter is defective. (Red) Lights up when sensor head is malfunction.
Controller	④ Power switch	The controller can be used 5 sec. approx. after the power supply is switched on. However, avoid use during the warm-up time (15 min. approx.) after the power supply is switched on.
	⑤ Power indicator (Orange LED)	Lights up when the power is ON.
	⑥ Operation indicator (Yellow LED)	Lights up when the sensing output is ON. Also lights up for 3 sec., 2 sec. after power supply is switched on.
	⑦ Alarm indicator (3-color LED)	(Green) Lights up under stable light condition. 2 sec. after the power supply is switched on, the LED lights up in red, orange, green, in turn, at 1 sec. interval. (Orange) Lights up when ALM. 1 is OFF (glass filter is defective). (Red) Lights up when ALM. 2 is OFF (sensor head is malfunction).
	⑧ Timer operation selection switch	Sets approx. 2 ms fixed OFF-delay timer at the sensing outputs (OUT 1 to OUT 12). (Alarm output is not incorporated with the timer function). OFD: OFF-delay timer operation NORM.: Normal operation
	⑨ Sensor head selection switch (Note 1)	Selects use / non-use of sensor head. When the switch of a channel not connected to a sensor head is ON, the alarm indicator (red) lights up.
	⑩ Sensitivity setting switch (Note 2)	Sets the sensitivity of a sensor head. (Left hand switch sets the same sensitivity for sensor heads 1 to 6. Right hand switch sets the same sensitivity for sensor heads 7 to 12. It is possible to set the sensitivity in the range 10 to 100 μm 0.394 to 3.937 mil (10 steps of 10 μm 0.394 mil pitch).)
	⑪ Line speed selection switch	Sets the line speed. HI: when the line speed is 500 m/min. or more, but 2,500 m/min. or less LO: when the line speed is 5 m/min. or more, but less than 500 m/min.

- Notes: 1) If the sensor head selection switch is operated when the glass filter of the connected sensor head is defective (alarm indicator lights up in orange color), the response time to the operation of the sensor head selection switch becomes slower. Further, the sensor head selection switch is not a switch to put the sensor head power supply ON / OFF.
- 2) Set the sensitivity setting switch at a position where a click is felt. If it is set in-between, it will not operate correctly.

PRECAUTIONS FOR PROPER USE



Setting of sensitivity

- Sensitivity setting switch sets the height of the smallest object to be sensed. Please note that an error exists, as given in the table below, for the smallest object to be sensed. Further, if sensing is not possible at the set sensitivity, lower the sensitivity setting switch by one step and perform the sensing once again.

Sensitivity setting switch	1	2	3	4	5	6	7	8	9	10
Minimum sensing object ($\mu\text{m mil}$)	10 0.394	20 0.787	30 1.181	40 1.575	50 1.969	60 2.362	70 2.756	80 3.150	90 3.543	100 3.937
Error ($\mu\text{m mil}$)	± 5 ± 0.197	± 6 ± 0.236	± 7 ± 0.276	± 8 ± 0.315	± 10 ± 0.394	± 11 ± 0.433	± 12 ± 0.472	± 13 ± 0.512	± 14 ± 0.551	± 15 ± 0.591

Selection of line speed

- Set the line speed selection switch according to the winding wire speed. Further, note that granular flaws will not be sensed if the use does not conform to the conditions specified in the table below.

Line speed selection switch	Corresponding winding wire speed
	500 m/min. or more, but 2,500 m/min. or less
	5 m/min. or more, but less than 500 m/min.

Timer function

- Sensing output is incorporated with an approx. 2 ms fixed OFF-delay timer. Since the output signal is extended by a fixed time period, this function is effective in cases where the response of the connected device is slow, etc.

Time chart

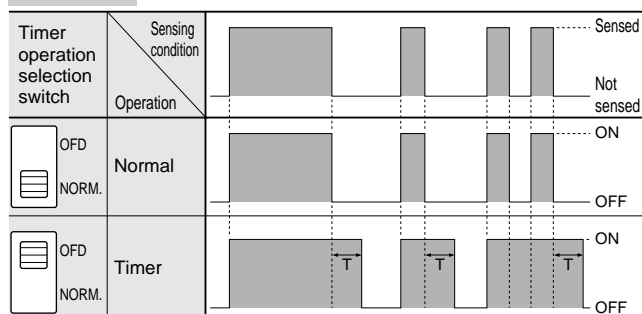

Note: Alarm output is not incorporated with the timer function.

Alarm indicator

- Please note that, although the orange alarm indicator (which lights up when glass filter is defective) responds in real time on the sensor head, it lights up after a time delay of 1.5 sec. per sensor head, as given in the table below, on the controller.

Number of connected sensor heads	1 No.	12 Nos.
Response time of controller	1.5 sec.	18 sec.

- Relation between the alarm indicator and the alarm output is as follows:

Alarm indicator (3-color LED)	Condition	Alarm output		Description
		ALM. 1	ALM. 2	
Green lights up	Stable light condition	ON	ON	The sensor is operating normally.
Orange lights up	Glass filter defective	OFF (Note 1)	ON	ALM. 1 turns OFF when glass filter is defective.
Red lights up	Sensor head malfunction	ON	OFF (Note 2)	ALM. 2 turns OFF when the sensor head cable is defective, the laser deteriorates or the sensing output is short-circuited.

Notes: 1) When several sensor heads are used, it will turn OFF when the glass filter of even one sensor head becomes defective.

2) When several sensor heads are used, it will turn OFF even if one sensor head becomes malfunction.

Maintenance

- In case the alarm indicator lights up in orange, since dust, dirt, etc., may be sticking to the glass filters (LA-TF), clean the glass filters as per the procedure given below.

- Remove the M2 pan head screws (2 pcs.) from the front face of the sensor head and pull the shading hood (LA-TH) in the direction of the arrow.
- Wipe the glass filters clean with a soft, lint-free cloth or lens paper.
- Mount the shading hood on the sensor head with the M2 pan head screws. In this case, the tightening torque should be 0.15 N·m or less.

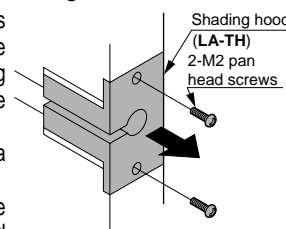

- If the alarm indicator lights up in orange even after the glass filters are cleaned, there may be a scratch on the glass filters. In this case, change the glass filters as per the procedure given below.

- After removing the shading hood (LA-TH), remove the M2 countersunk head screws (4 pcs.) from the sensor head side faces and pull the glass filters (LA-TF) in the direction of the arrow.

Note: Please take care that no dust, dirt, etc., enters the sensor head when the glass filters are removed.

- Change the glass filters and fix them to the sensor head with the M2 countersunk head screws. In this case, the tightening torque should be 0.27 N·m or less.
- Mount the shading hood on the sensor head. In this case, the tightening torque should be 0.15 N·m or less.

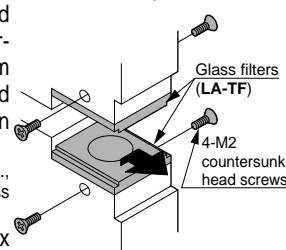

Wiring

- Make sure that the power supply is off while wiring.
- Verify that the supply voltage variation is within the rating.
- Since the internal circuit may get damaged due to a wrong connection, please ensure to check the connections before switching on the power supply.
- In case noise generating equipment (switching regulator, inverter motor, etc.) is used in the vicinity of this product, connect the frame ground (F.G.) terminal of the equipment to an actual ground.
- In this product, capacitor earth is used to enhance the noise characteristics. In case there is a high frequency noise generating equipment, such as, an ultrasonic welding machine, etc., near the sensor head and if the mounting base is electrically conducting (metallic, etc.), then insulate the sensor from the mounting base.
- If the used power supply generates a surge, connect a surge absorber to the power supply to absorb the surge.
- If an inductive load, such as, a DC relay, etc., is connected, take surge countermeasures.
- Do not run the wires together with high-voltage lines or power lines or put them in the same raceway. This can cause malfunction due to induction.
- Please make sure to connect the sensor head to the controller LA-TC12 using the exclusive cable.
- The cable of the sensor head can be extended up to total 14 m 45.932 ft with an exclusive cable.
- In order to minimize noise, make the wiring as short as possible.

Others

- Do not allow any water, oil, fingerprints, etc., which may refract light, or dust, dirt, etc., which may block light, to stick to the emitting / receiving surfaces of the sensor head. In case they are present, wipe them with a clean, soft cloth or lens paper.
- Avoid use in places where inflammable gas or corrosive gas may be emitted, where dust is excessive, where it may be exposed to water drops or where there may be excessive vibration or shock.

LA-T

DIMENSIONS (Unit: mm in) The CAD data in the dimensions can be downloaded from the SUNX website: <http://www.sunx.co.jp/>

LA-T11 Sensor head

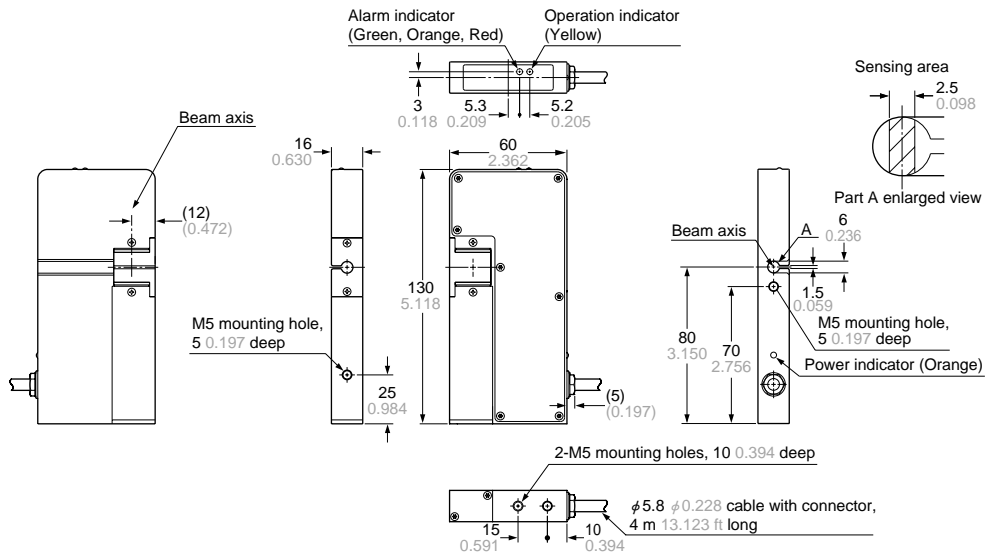

LA-TC12 Controller

