

GA-10 SERIES GH SERIES

Micro-size Inductive Proximity Sensor **Amplifier-separated**

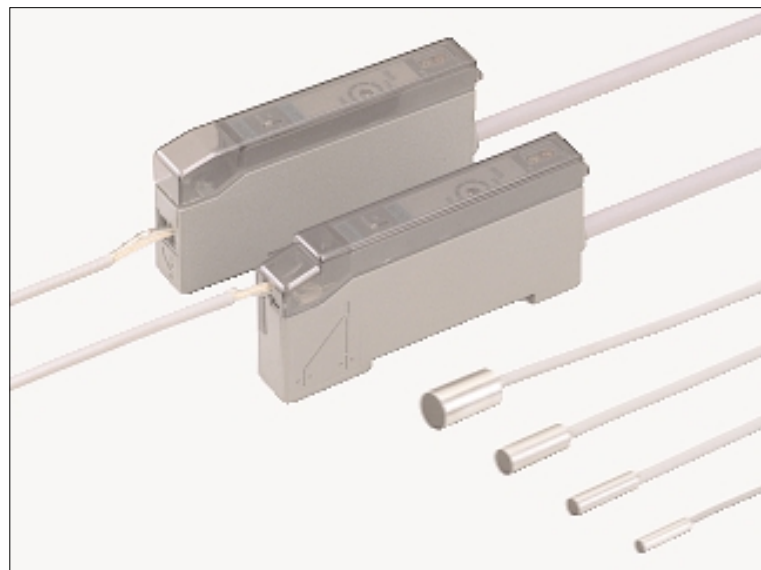

High accuracy sensing with a slim-size sensor

Slim & small

The amplifier is extremely slim, just 10 mm 0.394 in thick. This results in a compact size even if several amplifiers are mounted in a row. Moreover, the sensor head is also extremely small, the smallest being just $\phi 2.8$ mm $\phi 0.110$ in (GH-2S).

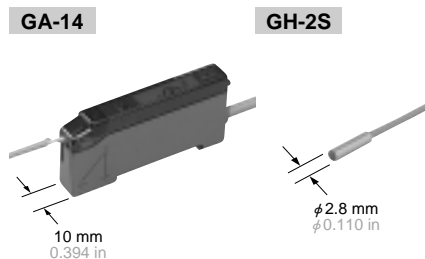

Reliable

The sensor heads (GH-3S, GH-5S, GH-8S and GH-F8S) have IP67 protection. Further, the tightening torque has been significantly improved due to its thick case.

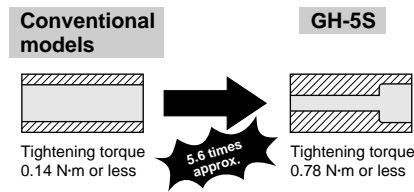

Accurate

Fine adjustments are possible by its 18-turn, wide adjustment range sensitivity adjuster. Besides, its repeatability is 1 μ m 0.039 mil or less and its temperature characteristics have been improved to twice as good as those of conventional models. Hence, it is suitable for high accuracy positioning applications.

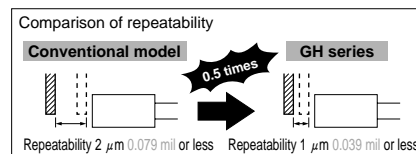
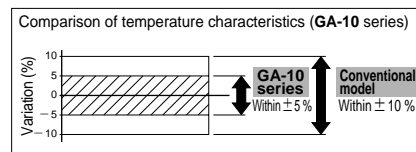

Screw tightening type available GA-15

GA-15 enables sensor head connection by screw tightening. Moreover, since the cover of the connecting portion is transparent, it is possible to confirm whether the connection is proper.

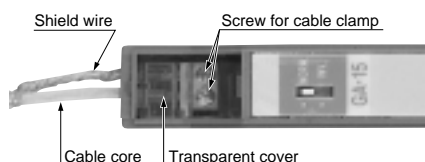

Disconnection alarm indicator

If the sensor head cable is damaged, or misconnected, the disconnection alarm indicator (orange LED) lights up for your attention.

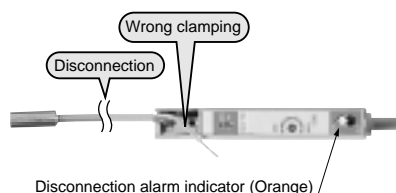

Wire-saving

Amplifier with a plug-in connector, which is connectable to the sensor block of an S-LINK system, or to the sensor block for simple wiring SL-BMW or SL-BW, or to a mating cable, is also available.

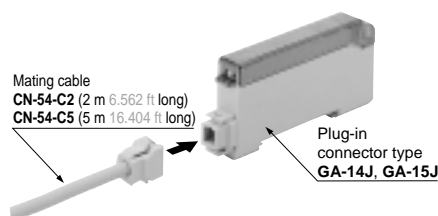

Note: The above photograph shows GA-14J.

APPLICATIONS

Inspecting presence of washer

The sensor detects the presence / absence of a washer by the height of the spring-loaded rod.

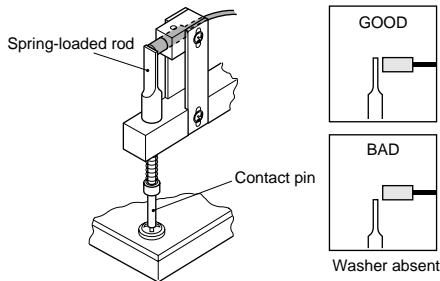

Aligning press molds

The sensor detects even a minute misalignment.

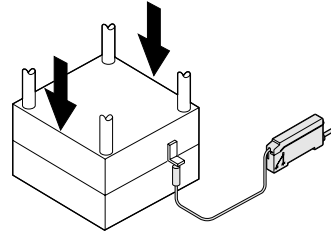

Detecting vibration of parts-feeder

The sensor detects whether the feeder is vibrating.

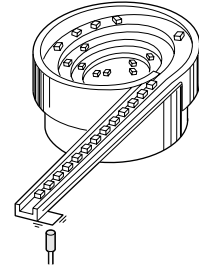

ORDER GUIDE

Sensor heads

Type	Appearance (mm in)	Sensing range (Note)	Model No.	Hysteresis
Cylindrical type		Maximum operation distance 1.2 mm 0.047 in (0 to 0.6 mm 0 to 0.024 in) ← Stable sensing range	GH-2S	0.07 mm 0.0028 in or less
		1.8 mm 0.071 in (0 to 0.8 mm 0 to 0.031 in)	GH-3S	0.05 mm 0.0020 in or less
		2.4 mm 0.094 in (0 to 1.0 mm 0 to 0.039 in)	GH-5S	
	Spatter-resistant type		4.0mm 0.157 in (0 to 2.0 mm 0 to 0.079 in)	GH-8S
			GH-F8S	

Note: The stable sensing range represents the sensing range for which the sensor can satisfy all the given specifications with the standard sensing object.

The maximum operation distance represents the maximum distance for which the sensor can detect the standard sensing object at +20 °C +68 °F constant ambient temperature.

Usage within the stable sensing range is recommended for accurate sensing applications.

Amplifiers

Type	Appearance	Model No.	Supply voltage	Output
One-touch clamping		GA-14	12 to 24 V DC ± 10 %	NPN open-collector transistor
Screw tightening		GA-15		

GA-10/GH

ORDER GUIDE

5 m 16.404 ft cable length type and plug-in connector type

5 m 16.404 ft cable length type (standard: 2 m 6.562 ft) and plug-in connector type (standard: cable type) are also available.

• Table of Model Nos.

Type	Standard	5 m 16.404 ft cable length type	Plug-in connector type
One-touch clamping	GA-14	GA-14-C5	GA-14J
Screw tightening	GA-15	GA-15-C5	GA-15J

Plug-in connector type is usable with the sensor & wire-saving link system **S-LINK**, sensor block for simple wiring **SL-BMW** or **SL-BW**, or with connector attached cable **CN-54-C2** or **CN-54-C5**.

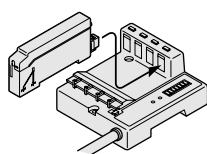

Sensor & wire-saving link system **S-LINK**

(Refer to p.1030~ for details.)

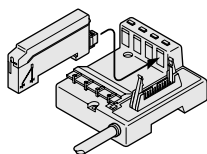

Sensor block for simple wiring **SL-BMW**, **SL-BW**

(Refer to p.882~ for details.)

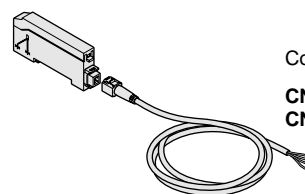

Connector attached cable

CN-54-C2 (2 m 6.562 ft long)

CN-54-C5 (5 m 16.404 ft long)

Accessory

- **MS-DIN-2** (Amplifier mounting bracket)

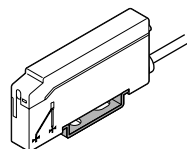

OPTIONS

Designation	Model No.	Description
Sensor head mounting bracket	MS-SS3	Mounting bracket for GH-3S
	MS-SS5	Mounting bracket for GH-5S
	MS-SS8	Mounting bracket for GH-8S

Sensor head mounting bracket

- **MS-SS3**
- **MS-SS5**
- **MS-SS8**

The sensor head can be easily fixed.

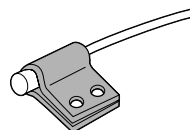

SPECIFICATIONS

Amplifiers

		Type	One-touch clamping	Screw tightening
Item	Model No.		GA-14	GA-15
Applicable sensor head		GH series		
Supply voltage		12 to 24 V DC \pm 10 % Ripple P-P 10 % or less		
Current consumption		25 mA or less		
Sensing output		NPN open-collector transistor • Maximum sink current: 100 mA • Applied voltage: 30 V DC or less (between sensing output and 0 V) • Residual voltage: 1 V or less (at 100 mA sink current) 0.4 V or less (at 16 mA sink current)		
	Output operation	Switchable either Normally open or Normally closed		
	Short-circuit protection	Incorporated		
Disconnection alarm output		NPN open-collector transistor • Maximum sink current: 100 mA • Applied voltage: 30 V DC or less (between disconnection alarm output and 0 V) • Residual voltage: 1 V or less (at 100 mA sink current) 0.4 V or less (at 16 mA sink current)		
	Output operation	ON when the sensor head cable is disconnected or misconnected		
	Short-circuit protection	—————		
Max. response frequency		3.3 kHz		
Operation indicator		Red LED (lights up when the sensing output is ON)		
Disconnection alarm indicator		Orange LED (lights up when the disconnection alarm output is ON)		
Sensitivity adjuster		18-turn potentiometer		
Environmental resistance	Ambient temperature	- 10 to + 60 °C + 14 to + 140 °F (No dew condensation or icing allowed), Storage : - 20 to + 70 °C - 4 to + 158 °F		
	Ambient humidity	35 to 85 % RH, Storage: 35 to 85 % RH		
	Noise immunity	Power line: 240 Vp, 10 ms cycle and 0.5 μ s pulse width; Radiation: 300 Vp, 10 ms cycle and 0.5 μ s pulse width (with noise simulator)		
	Voltage withstandability	1,000 V AC for one min. between all supply terminals connected together and enclosure		
	Insulation resistance	20 M Ω , or more, with 250 V DC megger between all supply terminals connected together and enclosure		
	Vibration resistance	10 to 150 Hz frequency, 0.75 mm 0.030 in amplitude in X, Y and Z directions for two hours each		
	Shock resistance	100 m/s ² acceleration (10 G approx.) in X, Y and Z directions for five times each		
Temperature characteristics (Note)		Within \pm 5 %		
Material		Enclosure: Heat-resistant ABS, Cover: Polycarbonate, Cable lock lever: PPS (GA-14 only), DIN rail stopper: POM		
Cable		0.2 mm ² 4-core cabtyre cable, 2 m 6.562 ft long		
Cable extension		Extension up to total 100 m 328.084 ft is possible with 0.3 mm ² , or more, cable.		
Weight		65 g approx.		
Accessories		MS-DIN-2 (Amplifier mounting bracket): 1 pc., Adjusting screwdriver: 1 pc.		

Note: The value of the temperature characteristics gives the variation in the operation distance, that has been set within the stable sensing range at + 20 °C + 68 °F, for an ambient temperature drift from 0 to + 55 °C + 32 to + 131 °F.

GXL	Amplifier Built-in
GL-6	
GL-8/8U	
GL-N12	
GL-18H/18HL	
GX-U/FU	
GX-N	
GX	
GA-10/GH	

GA-10/GH

SPECIFICATIONS

Sensor heads

Item	Type	Cylindrical type				Spatter-resistant type
	Model No.	GH-2S	GH-3S	GH-5S	GH-8S	GH-F8S
Applicable amplifier		GA-10 series				
Stable sensing range (Note 1)		0 to 0.6 mm 0 to 0.024 in	0 to 0.8 mm 0 to 0.031 in	0 to 1.0 mm 0 to 0.039 in	0 to 2.0 mm 0 to 0.079 in	
Max. operation distance (Note 1)		1.2 mm 0.047 in	1.8 mm 0.071 in	2.4 mm 0.094 in	4.0 mm 0.157 in	
Standard sensing object		Iron sheet 5 × 5 × t 1 mm 0.197 × 0.197 × t 0.039 in			Iron sheet 10 × 10 × t 1 mm 0.394 × 0.394 × t 0.039 in	
Hysteresis (Note 2)		0.07 mm 0.003 in or less	0.05 mm 0.002 in or less		0.04mm 0.002 in or less	
Repeatability (Note 2)		Along sensing axis, perpendicular to sensing axis: 1 μm or less				
Environmental resistance	Protection	IP50 (IEC)	IP67 (IEC), IP67g (JEM)			
	Ambient temperature	- 10 to + 60 °C 14 to + 140 °F, Storage: - 20 to + 70 °C - 4 to + 158 °F				
	Ambient humidity	35 to 85 % RH, Storage: 35 to 85 % RH				
	Vibration resistance	10 to 55 Hz frequency, 1.5 mm 0.059 in amplitude in X, Y and Z directions for two hours each				
	Shock resistance	500 m/s ² acceleration (50 G approx.) in X, Y and Z directions for five times each				
Temperature characteristics (Note 3)		Within ± 7 %	Within ± 5 %	Within ± 4 %		
Material		Enclosure: Stainless steel (SUS303) Sensing part: PVC	Enclosure: Stainless steel (SUS303) Sensing part: ABS	Enclosure: Stainless steel (SUS303) Sensing part: PAR	Enclosure: Stainless steel (SUS303) Sensing part: ABS	Enclosure: Stainless steel (SUS303) Sensing part: Fluorine resin
Cable		Oil resistant high-frequency coaxial cable, 3 m 9.843 ft long (Note 4)				Spatter resistant cable (cable sheath: fluorine resin), 3 m 9.843 ft long
Weight		15 g approx.	30 g approx.		40 g approx.	55 g approx.

Notes: 1) The stable sensing range represents the sensing range for which the sensor can satisfy all the given specifications with the standard sensing object. The maximum operation distance represents the maximum distance for which the sensor can detect the standard sensing object at + 20 °C + 68 °F constant ambient temperature. Usage within the stable sensing range is recommended for accurate sensing applications.
 2) Value is given for the stable sensing range.
 3) The value represents the variation in the operation distance, that has been set within the stable sensing range at + 20 °C + 68 °F, for an ambient temperature drift from 0 to + 55 °C + 32 to + 131 °F.
 4) The length of the sensor head cable cannot be changed.

I/O CIRCUIT AND WIRING DIAGRAMS

I/O circuit diagram

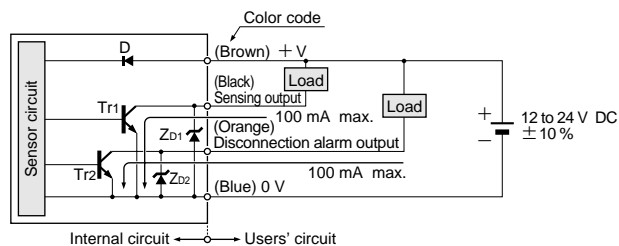

Symbols ... D: Reverse supply polarity protection diode
 Zd1, Zd2: Surge absorption zener diode
 Tr1, Tr2 : NPN output transistor

Wiring diagram

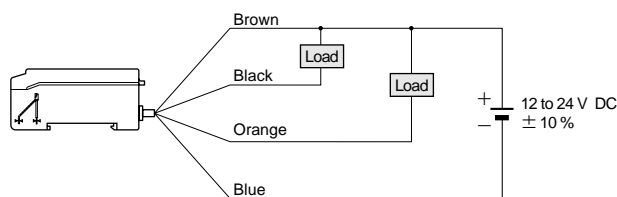

Pin position of plug-in connector type (GA-14J, GA-15J)

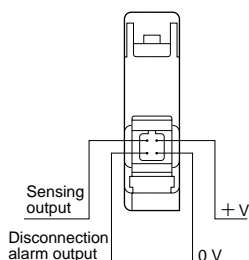

SENSING CHARACTERISTICS (TYPICAL)

GH-2S

Sensing field

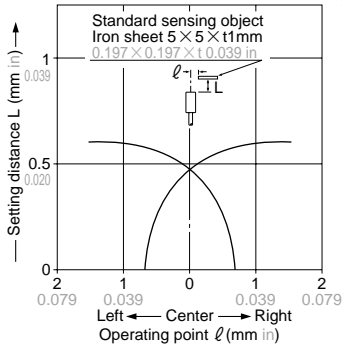

The graph on the left is plotted with the sensitivity adjusted so as to just detect a $5 \times 5 \times t$ mm $0.197 \times 0.197 \times t$ 0.039 in iron sheet placed at a distance of 0.6 mm 0.024 in.

Correlation between sensing object size and sensing range

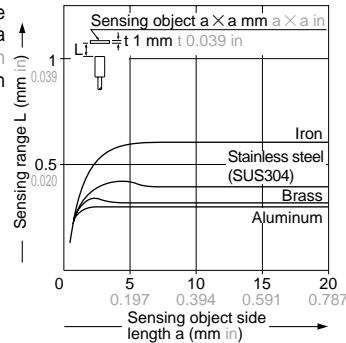

As the sensing object size becomes smaller than the standard size (iron sheet $5 \times 5 \times t$ mm $0.197 \times 0.197 \times t$ 0.039 in), the sensing range shortens as shown in the left figure.

(The graph on the left is plotted with the sensitivity adjusted so as to just detect a $5 \times 5 \times t$ mm $0.197 \times 0.197 \times t$ 0.039 in iron sheet placed at a distance of 0.6 mm 0.024 in.)

GH-3S

Sensing field

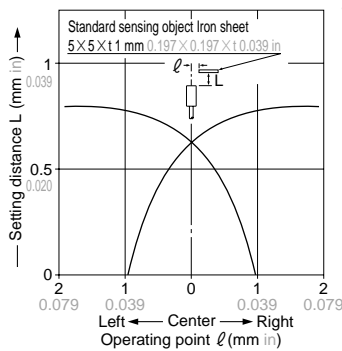

The graph on the left is plotted with the sensitivity adjusted so as to just detect a $5 \times 5 \times t$ mm $0.197 \times 0.197 \times t$ 0.039 in iron sheet placed at a distance of 0.8 mm 0.031 in.

Correlation between sensing object size and sensing range

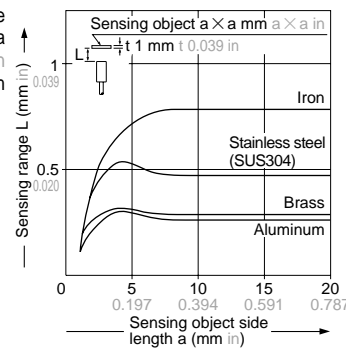

As the sensing object size becomes smaller than the standard size (iron sheet $5 \times 5 \times t$ mm $0.197 \times 0.197 \times t$ 0.039 in), the sensing range shortens as shown in the left figure.

(The graph on the left is plotted with the sensitivity adjusted so as to just detect a $5 \times 5 \times t$ mm $0.197 \times 0.197 \times t$ 0.039 in iron sheet placed at a distance of 0.8 mm 0.031 in.)

GH-5S

Sensing field

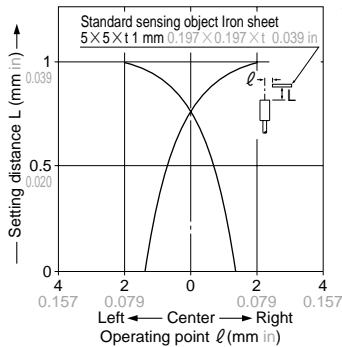

The graph on the left is plotted with the sensitivity adjusted so as to just detect a $5 \times 5 \times t$ mm $0.197 \times 0.197 \times t$ 0.039 in iron sheet placed at a distance of 1.0 mm 0.039 in.

Correlation between sensing object size and sensing range

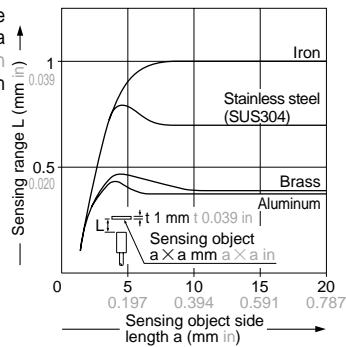

As the sensing object size becomes smaller than the standard size (iron sheet $5 \times 5 \times t$ mm $0.197 \times 0.197 \times t$ 0.039 in), the sensing range shortens as shown in the left figure.

(The graph on the left is plotted with the sensitivity adjusted so as to just detect a $5 \times 5 \times t$ mm $0.197 \times 0.197 \times t$ 0.039 in iron sheet placed at a distance of 1.0 mm 0.039 in.)

GH-8S GH-F8S

Sensing field

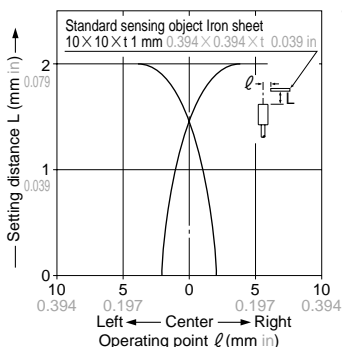

The graph on the left is plotted with the sensitivity adjusted so as to just detect a $10 \times 10 \times t$ mm $0.394 \times 0.394 \times t$ 0.039 in iron sheet placed at a distance of 2.0 mm 0.079 in.

Correlation between sensing object size and sensing range

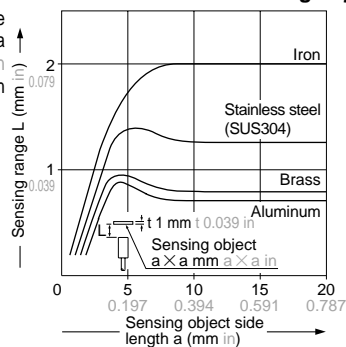

As the sensing object size becomes smaller than the standard size (iron sheet $10 \times 10 \times t$ mm $0.394 \times 0.394 \times t$ 0.039 in), the sensing range shortens as shown in the left figure.

(The graph on the left is plotted with the sensitivity adjusted so as to just detect a $10 \times 10 \times t$ mm $0.394 \times 0.394 \times t$ 0.039 in iron sheet placed at a distance of 2.0 mm 0.079 in.)

GXL

GL-6

GL-8/8U

Amplifier Built-in

GL-N12

GL-18H/18HL

GX-U/FU

GX-N

GX

Amplifier-separated

GA-10/GH

GA-10/GH

PRECAUTIONS FOR PROPER USE

Refer to p.1152~ for general precautions.



This product is not a safety sensor. Its use is not intended or designed to protect life and prevent body injury or property damage from dangerous parts of machinery. It is a normal object detection sensor.

Mounting of the amplifier

- Make sure to connect the **GH** sensor head to the **GA-10** amplifier correctly, or malfunction will occur.
- Do not shorten or lengthen the sensor head cable.

How to mount the amplifier

- ① Fit the rear part of the amplifier on the attached amplifier mounting bracket (**MS-DIN-2**) or a 35 mm 1.378 in width DIN rail.
- ② Press down the front part of the amplifier on the attached amplifier mounting bracket (**MS-DIN-2**) or DIN rail to fit it.

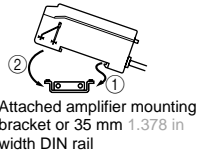

How to remove the amplifier

- ① Push the amplifier forward.
- ② Lift up the front part of the amplifier to remove it.

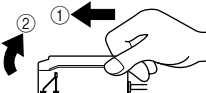

Note: Please take care that if the front part is lifted without pushing the amplifier forwards, the hooks on the rear portion of the mounting section are likely to break.

Sensor head cable connection

GA-14□

- ① Prepare the cable end as shown in the right figure, and twist the shield wire and the cable core inner conductor, respectively. If they are not twisted properly, they may not enter the inlets resulting in mis-connection.

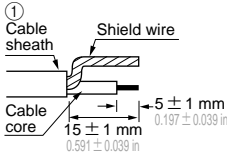

Note: Peel off the cable sheath and notice that along with the core wire itself, there is another shield wire. Separate the shield wire from the core wire and proceed with mounting.

- ② Open the cover.
- ③ Flip the cable lock lever down.
- ④ Referring to the cable connection diagram at the side of the amplifier, insert the shield wire and the cable core straight into the inlets, without bending them.
- ⑤ Flip up the cable lock lever to lock the cable.
- ⑥ Make sure to fit the cover on the amplifier after connecting the sensor head.

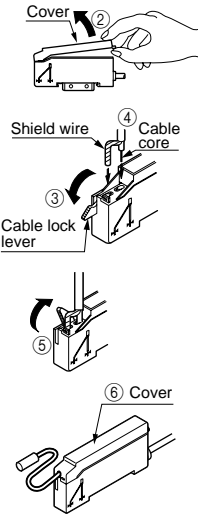

Note: If there is a shred of the cable left inside the cable inlet, remove it before connecting the sensor head cables. Turn the amplifier upside down, and tap it around the holes. If the shred still remains, peel the bottom seal off the amplifier, and drop it out. (The seal is reusable.)

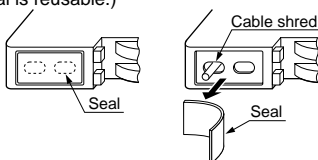

GA-15□

- ① Prepare the cable end as shown in the right figure, and twist the shield wire and the cable core inner conductor, respectively.

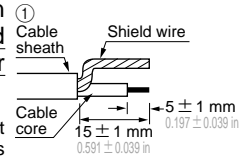

Note: Peel off the cable sheath and notice that along with the core wire itself, there is another shield wire. Separate the shield wire from the core wire and proceed with mounting.

- ② Open the cover.
- ③ Loosen the screw for the cable clamp by turning it counterclockwise.
- ④ Referring to the cable connection diagram at the side of the amplifier, insert the shield wire and the cable core straight into the inlets, without bending them.
- ⑤ Tighten the screw for the cable clamp by turning it clockwise. The tightening torque should be 0.15 N·m or less.
- ⑥ Make sure to fit the cover on the amplifier after connecting the sensor head.

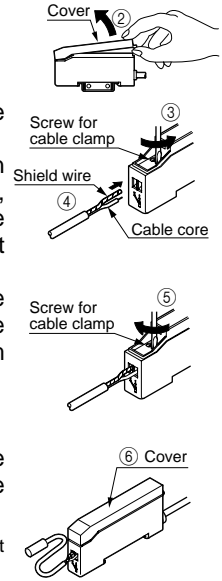

Note: Take care since the shield wire may get slightly exposed.

Mounting of the sensor head

How to mount the sensor head

- The tightening torque should be as given below. Make sure to use a set screw with a cup-point end.

Model No.	Tightening torque	A (mm in)
GH-2S	0.17 N·m	3 0.118 or more
GH-3S	0.17 N·m	4 0.157 or more
GH-5S	0.78 N·m	5 0.197 or more
GH-8S GH-F8S	0.59 N·m	5 0.197 or more

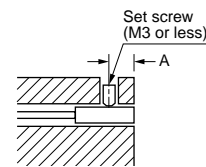

Note: Do not tighten excessively.

Distance from surrounding metal

- If there is a metal near the sensor head, it may affect the sensing performance. Keep the minimum distance specified in the table below.

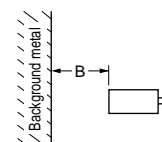

Model No.	B (mm in)
GH-2S	3 0.118
GH-3S	4 0.157
GH-5S	5 0.197
GH-8S GH-F8S	9 0.354

PRECAUTIONS FOR PROPER USE

Refer to p.1152~ for general precautions.

Mutual interference

- When two or more sensors are installed in parallel or face to face, keep the minimum separation distance specified below to avoid mutual interference.

<Face to face mounting> <Parallel mounting>

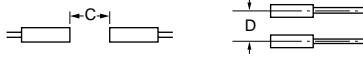

Model No.	C(mm/in)	D(mm/in)
GH-2S	15 0.591	10 0.394
GH-3S	20 0.787	15 0.591
GH-5S	25 0.984	20 0.787
GH-8S GH-F8S	40 1.575	26 1.024

Sensing range

- The sensing range is specified for the standard sensing object. With a non-ferrous metal, the sensing range is obtained by multiplying with the correction coefficient specified below.

Correction coefficient

Model No.	GH-2S	GH-3S	GH-5S	GH-8S GH-F8S
Metal				
Iron	1	1	1	1
Stainless steel (SUS304)	0.68 approx.	0.55 approx.	0.69 approx.	0.64 approx.
Brass	0.53 approx.	0.35 approx.	0.41 approx.	0.37 approx.
Aluminum	0.51 approx.	0.33 approx.	0.39 approx.	0.32 approx.

Part description

GA-14

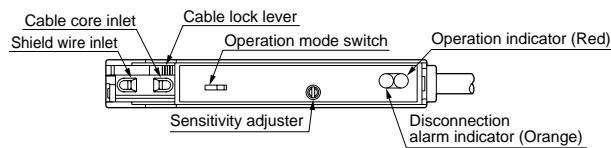

GA-15

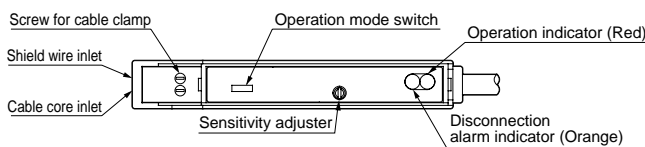

Sensitivity adjustment

Step	Sensing condition	Adjustment	Sensitivity adjuster
①	Set the operation mode switch to NORM. (Initial setting)	• Turn the sensitivity adjuster fully counterclockwise. (Minimum sensitivity)	
②	Approach along sensing axis 	• Place the sensing object within the stable sensing range. • Turn the sensitivity adjuster clockwise and set it at the point (A) where the operation indicator lights up.	
	Approach perpendicular to sensing axis 	• Place the sensing object within the stable sensing range. • Turn the sensitivity adjuster clockwise, and set it at the optimum sensing point (B) which is a little beyond the point (A) where the operation indicator lights up.	
③	Select the operation mode as per your application. (NORM.: Normally open, INV.: Normally closed)		

Note: Use the accessory screwdriver to turn the adjuster slowly. Turning with excessive strength will cause damage to the adjuster.

Others

- Do not use during the initial transient time (500 ms) after the power supply is switched on.
- Do not use the sensor at places having intense vibrations, as this can cause malfunction.
- When the sensor head is mounted on a moving base, stress should not be applied to the sensor cable joint.

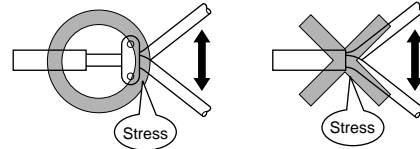

GA-10/GH

DIMENSIONS (Unit: mm in)

GA-14 Amplifier

Assembly dimensions with attached amplifier mounting bracket

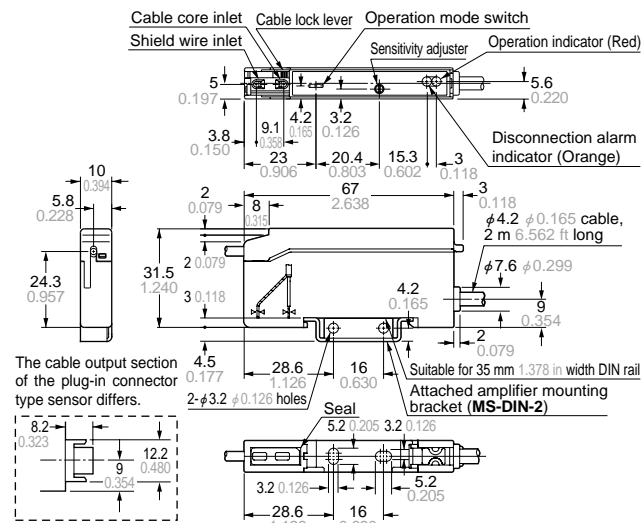

Note: The top view is without the cable and the cover.

GA-15 Amplifier

Assembly dimensions with attached amplifier mounting bracket

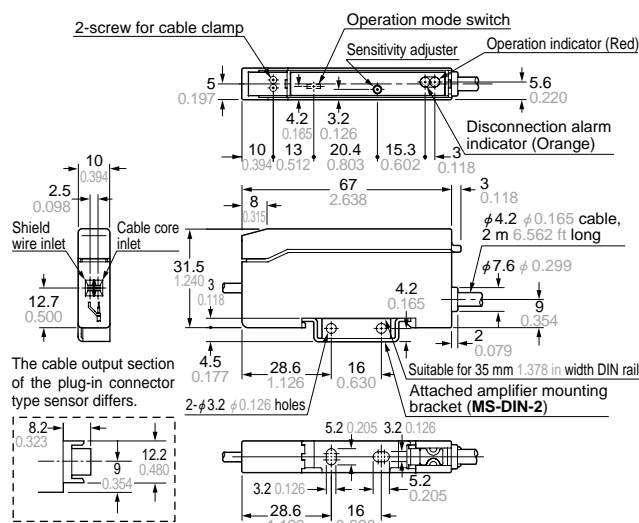

Note: The top view is without the cable and the cover.

MS-DIN-2 Amplifier mounting bracket (Accessory for amplifier)

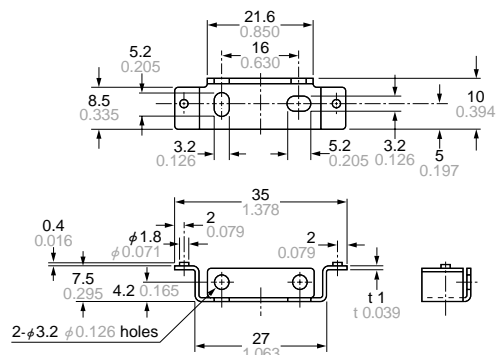

Material: Cold rolled carbon steel (SPCC)
(Uni-chrome plated)

GH-2S GH-3S GH-5S GH-8S GH-F8S Sensor head

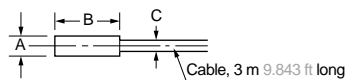

Model No.	A	B	C
GH-2S	φ2.8 φ0.110	12 0.472	φ1.6 φ0.063
GH-3S	φ3.8 φ0.150	15 0.591	φ2.5 φ0.098
GH-5S	φ5.4 φ0.213	15 0.591	φ2.5 φ0.098
GH-8S	φ8.0 φ0.315	15 0.591	φ2.5 φ0.098
GH-F8S	φ8.0 φ0.315	15 0.591	φ2.65 φ0.104

MS-SS3 MS-SS5 MS-SS8 Sensor head mounting bracket (Optional)

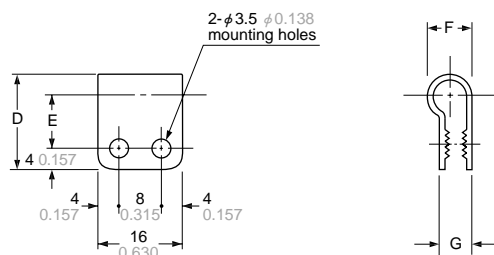

Material: Nylon 66

Symbol	Model No.	MS-SS3	MS-SS5	MS-SS8
D		16 0.630	18 0.709	20 0.787
E		9 0.354	10 0.394	11 0.433
F		6.3 0.248	8.3 0.327	10.3 0.406
G		4.9 0.193	6.1 0.240	6.5 0.256
Applicable sensor head model No.		GH-3S	GH-5S	GH-8S