

FX-301 SERIES

New

Digital Fiber Sensor



Fiber Selection

FX-301

FX-302

Digital Setting

FX-303

FX-CH

Bank Selection Unit

FX-311

Manually Set

FX-11A

Analog Output

FZ-10

Color Detection



Superior performance and advanced user-friendly multi-functionality enables expert usage on the very first day

* Passed the UL 991 Environment Test



* UL 61010C-1 compatible, Passed the UL 991 Environment Test based on SEMI S2-0200.
 [Category applicable for semiconductor manufacturing: TWW2, Process Equipment]
 [Applicable standards: UL 61010C-1]
 [Additional test / evaluation standards as per intended use: UL 991, SEMI S2-0200]

Long-range sensing made possible with built-in optical lens

For the first time in the industry, an optical 'double coupling lens' has been incorporated directly into the fiber sensor itself. This lens maximizes the light emission efficiency, resulting in a tremendous improvement in the sensing range. Sensing ranges with small diameter fibers and ultra-small diameter fibers, which have become very popular in recent years due to the miniaturization of chip components, have been increased by 50 % over previous values achieved with other amplifiers.

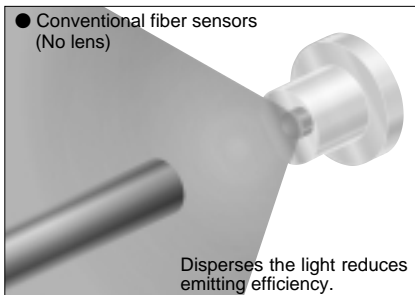
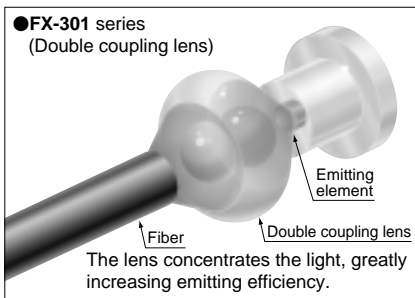

Stable long-term sensing

The newly developed four-chemical emitting element that uses the **FX-301** (red LED type) suppresses changes over long periods of time as much as possible, so that a stable light emitting level is maintained. There is very little element deterioration so that stable and accurate sensing can be maintained over long periods.

Selectable response time

We offer 4 selectable levels to correspond with various applications: the response time 150 μ s FAST mode, the LONG mode, perfect for adverse environments, and the S-D mode, especially made for minute detection.

Selectable sensing range as per the application	
Ex.: the FX-301 fiber sensor and the FT-B8 fiber	
LONG	1,100 mm 43.307 in Long range mode (LONG): Response time 2 ms
STD	530 mm 20.866 in Standard mode (STD): Response time 250 μ s
FAST	400 mm 15.748 in High-speed mode (FAST): Response time 150 μ s
S-D	180 mm 7.087 in Reduced light intensity mode (S-D): Response time 250 μ s

※The S-D mode can be set in the red LED type only.

Enhanced worksite-friendly installability

Our new fiber cutter utilizes a specially developed two-in-one fiber attachment that now makes it possible to cut two fibers simultaneously to exactly the same length. Also, since the fibers can be attached to the amplifier while being fixed in position in the two-in-one fiber attachment, sensitivity changes due to variation in the amount of fiber insertion do not occur.

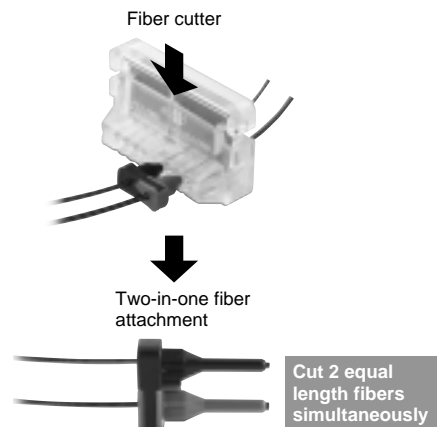

Easy maintenance, as main and sub units are identical

Both main and sub units utilize the same amplifier body. This feature allows for easy mounting in the side-by-side configuration. The main and sub unit functions are distinguished only by the proper use of 3-core main cable and the 1-core sub cable. Moreover, by utilizing the same body for both main and sub units, inventory management and maintenance is simplified.

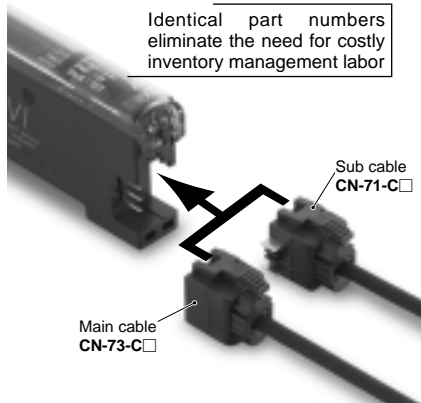

Wiring- and labor-saving design allows side-by-side configuration for up to sixteen units

Up to sixteen amplifiers can be connected in a side-by-side configuration. As the sub cable contains only one output line, a great amount of wiring and space can be saved. Also, special 'sliding' connectors have been provided for all main and sub cables, which can be detached merely by releasing the lock and pulling directly back, without having to slide the amplifier body to the side. Using this connector system, only a minimal amount of space is required for regular maintenance.

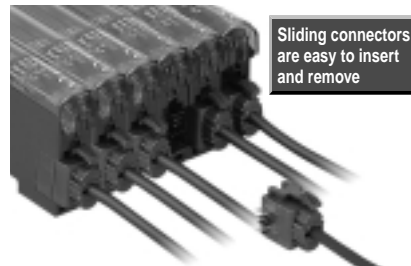

Environmentally friendly packaging









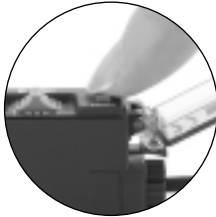











With regard to effects on the environment, we only utilize the simplest of packaging methods greatly contributing to the reduction in wastes generated by your worksite. Also, the bags are made of polyethylene, a substance that doesn't give off polluting gases when burned.



Even beginners can quickly learn how to use the MODE NAVI







MODE NAVI uses six indicators to display the amplifier's basic operations. The current operating mode can be confirmed at a glance, so even a first time user can easily operate the amplifier without becoming confused.

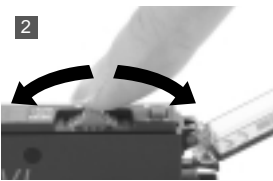

<p>RUN</p> <p>This is the sensing mode. Incident light level is displayed in the digital display.</p>  <p>PUSH  </p>	<p>TEACH</p> <p>This mode is for setting the threshold value.</p>  <p>PUSH  → </p>	<p>ADJ</p> <p>In this mode, the threshold value, once set, may be fine-tuned.</p>  <p>PUSH  →   </p>
<p>PRO</p> <p>This mode allows the selection of further advanced functions, such as the copying of individual settings and the memory functions.</p>  <p>←  </p>	<p>TIMER</p> <p>This mode permits the choice of using or not using the timer.</p>  <p>←  </p>	<p>L/D ON</p> <p>This mode allows the selection of output operation as either Light-ON or Dark-ON.</p>  <p>←  </p>

The use of only two switches makes for very simple operations

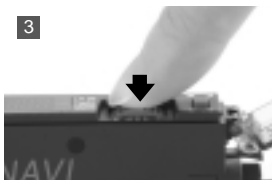
Only two switches, the large jog switch and the large MODE key, are required for operation. Depressing the large MODE key sets the 'mode selection' and 'mode cancel' functions. The large jog switch is used to select from the detailed functions available within each mode, as well as to change numerical values after the mode has been chosen.

<p>Large MODE key</p> <p>1</p>  <p> Pressing the switch selects or cancels the operating mode</p>	<p>Large jog switch</p> <p>2</p>  <p> Moving the switch from side to side allows items to be selected</p>	<p>3</p>  <p> Pressing the switch then confirms the selected setting</p>
--	--	---

FX-301

4 types of light sources available

In addition to our red LED (four-chemical emitting element) type, the blue, green, and infrared LED types are also provided to correspond to your specific application.

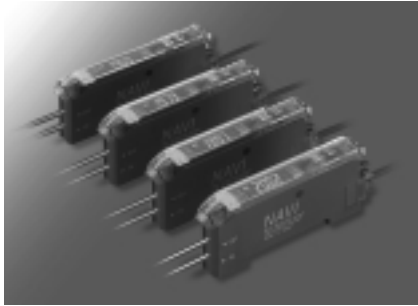

Optical communication function lets multiple sensors be adjusted all at once

The optical communication function allows the data that is currently set to be copied and saved all at once for all amplifiers connected together from the right side. This greatly reduces troublesome setup tasks and makes setup much smoother.

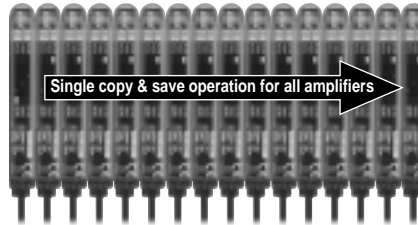

Equipped with each type of timer

These sensors are equipped with 3 types of timers, ON-delay, OFF-delay, and ONE SHOT, for compatibility to variegated environments.

- **ON-delay timer**
This function is useful for sensing only objects taking a long time travel.
- **OFF-delay timer**
This function is useful when the connected device has a slow response time.
- **ONE SHOT timer**
This function is useful when the input specifications of the connected device require a signal of fixed width.

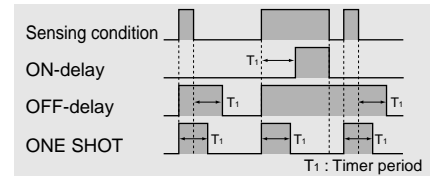

Easy code input setting

Every function can be directly set merely by the input of a four digit code (numbers) from the code table. This convenient feature is easy to set up. In the event that settings are accidentally changed at the operating site, merely entering the correct code can restore the original settings. This results in easy and quick maintenance.

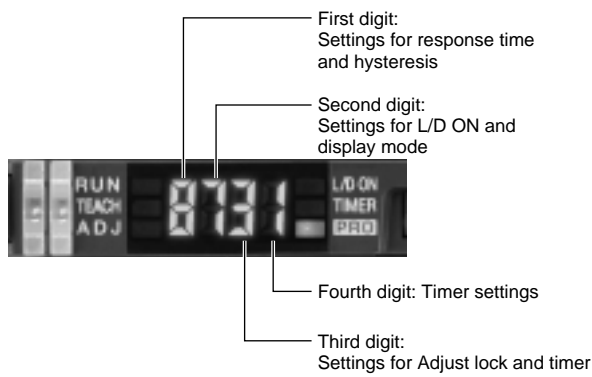

[Code setting table]

Direct code	First digit		Second digit		Third digit		Fourth digit
	Response time	Hysteresis	L/D ON	Display mode	Adjust lock	Timer	Timer setting
0	STD	H-02 (standard)	L-ON	digit	ON	OFF	OFF
1	STD	H-03 (large)	L-ON	%	ON	OFF-delay	1 ms
2	STD	H-01 (small)	L-ON	Peak hold	ON	ON-delay	3 ms
3	LONG	H-02 (standard)	L-ON	Bottom hold	ON	ONE SHOT	5 ms
4	LONG	H-03 (large)	D-ON	digit	OFF	OFF	10 ms
5	LONG	H-01 (small)	D-ON	%	OFF	OFF-delay	30 ms
6	FAST	H-02 (standard)	D-ON	Peak hold	OFF	ON-delay	50 ms
7	FAST	H-03 (large)	D-ON	Bottom hold	OFF	ONE SHOT	100 ms
8	FAST	H-01 (small)					300 ms
9	S-D	H-02 (standard)					500 ms

■ represents a description of the setting in the picture on the left.

Invertible digital display

The digital display can be inverted as per its orientation once mounted onto the amplifier.



Selectable cable length

Made available are 3 lengths, 1 m 3.281 ft, 2 m 6.562 ft, and 5 m 16.404 ft, to suit your application requirements. This helps reduce the waste caused by cutting cables and lightens the installation workload.

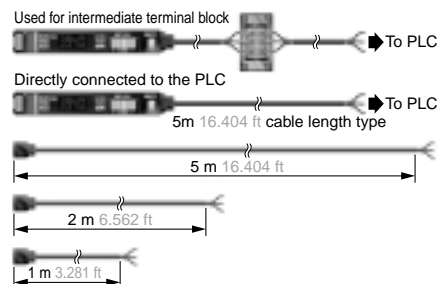

Optional units for greater freedom and control when installing

Sensor-PLC connection system

SC SERIES

This wire-saving system enables the collective connection of up to 16 I/O devices with an MIL connector. Scattered installation is also possible with the help of a sensor separate unit.
(Refer to p.876 ~ for details)



Bank selection unit

FX-CH SERIES

Without directly manipulating the sensor itself, you can simultaneously switch up to 16 fiber sensors' settings using an external emitted signal. (Load and save)
※Also possible with the FX-301 series' databank function
(Refer to p.144 ~ for details)

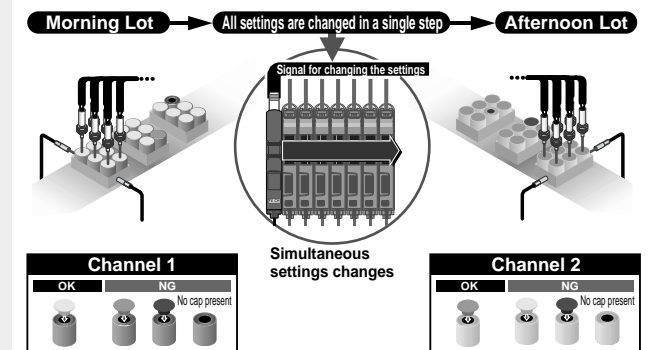
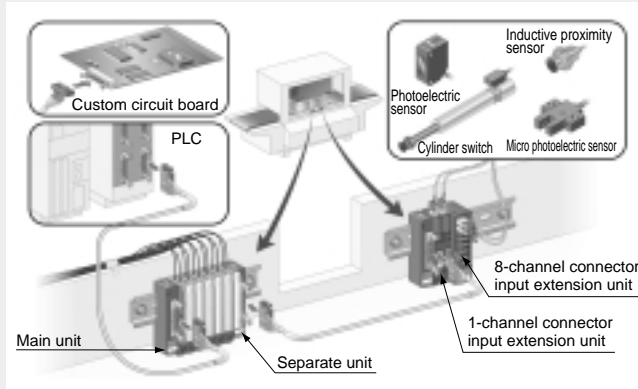

APPLICATIONS

Workpieces detection

This standard type of FX-301 using red light has a four-chemical emitting element for stable sensing over long periods.

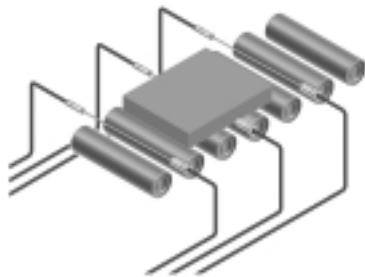

Sensing semi-transparent stickers

The blue LED type greatly reduces the dampening rate, making it ideal for delicate sensing.

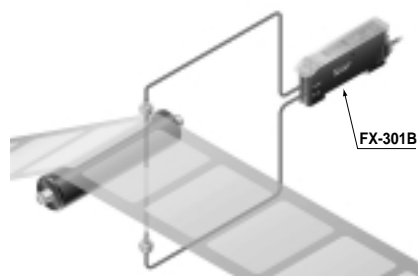

Sensing register marks

The green LED type can accurately discriminate between red and yellow, that cannot be easily detected using red LED type.

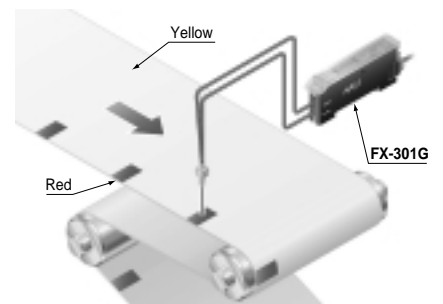

Sensing film meandering

Infrared LED type is ideal for sensing environments with light restrictions, such as places where light-sensitive film is being handled. (The emission peak wavelength: 940 nm 0.037 mil.) It includes full-auto teaching function which allows sensitivity to be set without stopping the workpiece line.

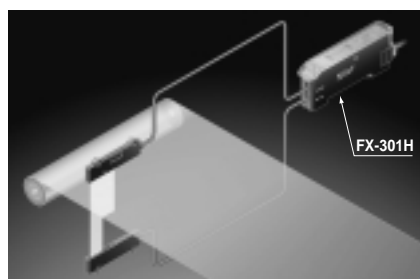

Detecting chip component

Because of low light intensity fluctuations when detecting minute moving objects, decrease the hysteresis in PRO mode and accurate sensing will be possible in high-speed mode. This method is optimal for chip component verification in taping equipment.

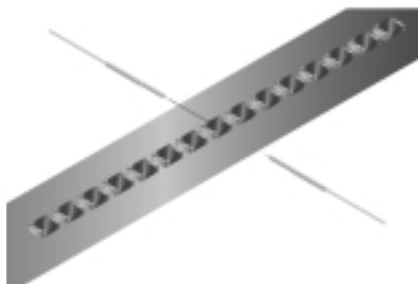

Detecting register marks on a transparent sheet

When detecting registration marks on transparent film with a thru-beam type, the S-D (reduced light intensity) mode will enable minute light intensity fluctuation sensing.

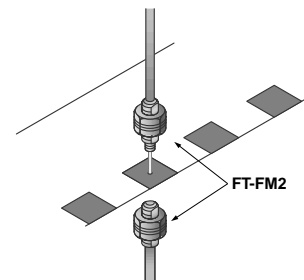

FX-301

ORDER GUIDE

Amplifiers Quick-connection cable is not supplied with the amplifier. Please order it separately.

Type	Appearance	Model No.	Emitting element	Output
Digital		FX-301	Red LED	NPN open-collector transistor
		FX-301B	Blue LED	
FX-301G		Green LED		
FX-301H		Infrared LED		
PNP output		FX-301P	Red LED	PNP open-collector transistor
		FX-301BP	Blue LED	
		FX-301GP	Green LED	
		FX-301HP	Infrared LED	

Quick-connection cables Quick-connection cable is not supplied with the amplifier. Please order it separately.

Type	Model No.	Description
Main cable	CN-73-C1	Length: 1 m 3.281 ft
	CN-73-C2	Length: 2 m 6.562 ft
	CN-73-C5	Length: 5 m 16.404 ft
Sub cable	CN-71-C1	Length: 1 m 3.281 ft
	CN-71-C2	Length: 2 m 6.562 ft
	CN-71-C5	Length: 5 m 16.404 ft

0.15 mm² 3-core cabtyre cable, with connector on one end
Cable outer diameter: ϕ 3.0 mm ϕ 0.118 in

0.15 mm² 1-core cabtyre cable, with connector on one end
Cable outer diameter: ϕ 3.0 mm ϕ 0.118 in

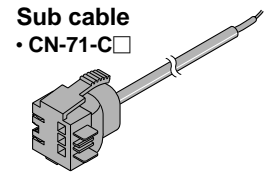
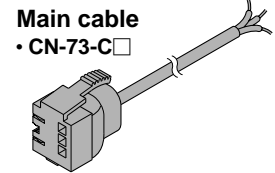

End plates End plates are not supplied with the amplifier. Please order separately when the amplifiers are mounted in cascade.

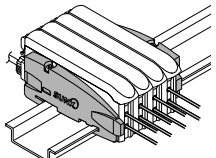
Appearance	Model No.	Description
	MS-DIN-E	When cascading multiple amplifiers, or when it moves depending on the way it is installed on a DIN rail, these end plates ensure that all amplifiers are mounted together in a secure and fully connected manner. Two pcs. per set

OPTIONS

Designation	Model No.	Description
Amplifier mounting bracket	MS-DIN-2	Mounting bracket for amplifier
Fiber amplifier protective seal	FX-MB1	10 sets of 2 communication window seals and 1 connector seal Communication window seal: It prevents malfunction due to transmission signal from another amplifier, as well as, prevents effect on another amplifier. Connector seal: It prevents contact of any metal, etc., with the pins of the quick-connection cable.

Amplifier mounting bracket
• MS-DIN-2

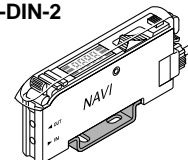



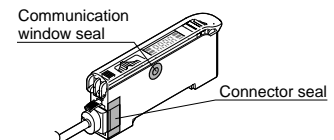



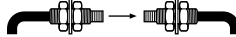











Fiber amplifier protective seal
• FX-MB1



LIST OF FIBERS

Standard fibers [Thru-beam type (one pair set)] 

Type	Shape of fiber head (mm in)	Sensing range (mm in) (Note 1)				Min. sensing object (under the optimum) (condition (Note 2))	Fiber cable length (Free-cut)	Allowable bending radius	Model No.		
		Red LED	Blue LED	Green LED	Infrared LED						
Long sensing range	With lens 	19,500 767.715 14,000 551.180 10,000 393.700 3,800 149.606	5,400 212.598 2,700 106.299 1,900 74.803	2,800 110.236 1,400 55.118 1,000 39.370	2,400 94.488 1,200 47.244 900 35.433 (Note 3)	φ 0.4 mm φ 0.016 in opaque object	10 m 32.808 ft	R25 mm R0.984 in	FT-FM10L		
	With lens 	1,600 62.992 800 31.496 580 22.835 280 11.024	400 15.748 200 7.874 130 5.118	200 7.874 100 3.937 65 2.559	155 6.102 77 3.031 55 2.165	φ 0.02 mm φ 0.0008 in opaque object	2 m 6.562 ft		FT-SFM2L		
	Lens mountable 	1,100 43.307 530 20.866 400 15.748 180 7.087	220 8.661 110 4.331 75 2.953	110 4.331 55 2.165 40 1.575	100 3.937 50 1.969 30 1.181	φ 0.04 mm φ 0.0016 in opaque object	2 m 6.562 ft		FT-B8		
	Lens mountable 	1,000 39.370 480 18.898 360 14.173 168 6.614	200 7.874 100 3.937 70 2.756	100 3.937 50 1.969 35 1.378	90 3.543 45 1.772 28 1.102	φ 0.03 mm φ 0.0012 in opaque object	2 m 6.562 ft (Note 4)		FT-NB8		
	Lens mountable 							R25 mm R0.984 in	FT-FM2		
	Sleeve 90 mm 3.543 in 							Fiber R25 mm R0.984 in Sleeve R10 mm R0.394 in	FT-FM2S		
	Sleeve 40 mm 1.575 in 	780 30.709 400 15.748 280 11.024 130 5.118	150 5.906 75 2.953 40 1.575	70 2.756 35 1.378 24 0.945	50 1.969 25 0.984 18 0.709	φ 0.03 mm φ 0.0012 in opaque object	2 m 6.562 ft		FT-FM2S4		
	Lens mountable 							R25 mm R0.984 in	FT-T80		
	Lens mountable 								FT-SFM2		
	Standard	Lens mountable 	700 27.559 360 14.173 250 9.843 126 4.961	140 5.512 70 2.756 40 1.575	66 2.598 33 1.299 22 0.866	45 1.772 22 0.866 17 0.669	φ 0.03 mm φ 0.0012 in opaque object	2 m 6.562 ft (Note 4)	R25 mm R0.984 in	FT-N8	
Lens mountable 							R25 mm R0.984 in	FT-NFM2			
Sleeve 90 mm 3.543 in 		270 10.630 140 5.512 100 3.937 49 1.929	50 1.969 25 0.984 16 0.630	24 0.945 12 0.472 8 0.315	16 0.630 8 0.315 5 0.197	φ 0.025 mm φ 0.0010 in opaque object	2 m 6.562 ft	Fiber R25 mm R0.984 in Sleeve R10 mm R0.394 in	FT-NFM2S		
Sleeve 40 mm 1.575 in 									FT-NFM2S4		
Lens mountable 								R25 mm R0.984 in	FT-SNFM2		
Elbow		Lens mountable 	530 20.866 230 9.055 150 5.906 80 3.150	85 3.346 42 1.654 28 1.102	44 1.732 22 0.866 16 0.630	32 1.260 16 0.630 12 0.472	φ 0.04 mm φ 0.0016 in opaque object	2 m 6.562 ft	R25 mm R0.984 in	FT-R80	
		Side-view		2,000 78.740 1,000 39.370 800 31.496 350 13.780	400 15.748 200 7.874 130 5.118	200 7.874 100 3.937 65 2.559	150 5.906 75 2.953 40 1.575	φ 0.05 mm φ 0.0019 in opaque object	2 m 6.562 ft	R25 mm R0.984 in	FT-V10 ^{New}
				400 15.748 200 7.874 140 5.512 70 2.756	80 3.150 40 1.575 28 1.102	40 1.575 20 0.787 14 0.551	30 1.181 15 0.591 12 0.472				FT-SFM2SV2
				390 15.354 180 7.087 125 4.921 63 2.480	50 1.969 25 0.984 16 0.630	26 1.024 13 0.512 8 0.315	44 1.732 22 0.866 15 0.591	φ 0.02 mm φ 0.0008 in opaque object	1 m 3.281 ft		FT-V22
			175 6.890 80 3.150 60 2.362 27 1.063	28 1.102 14 0.551 10 0.394	14 0.551 7 0.276 5 0.197	10 0.394 5 0.197 3 0.118		2 m 6.562 ft		FT-V41	

Notes: 1) Please take care that the sensing range of the free-cut type fiber may be reduced by 20 % max. depending upon how the fiber is cut. In addition, the infrared type is easily affected by humidity, so contact our office if using these sensors in environments with high humidity or where humidity levels can fluctuate.

2) The minimum sensing object size is the value for red LED type. Please contact our office for information on the minimum sensing object size if using amplifiers other than red LED type.

The optimum condition is the condition when the sensitivity is set so that the sensing output just changes to light incident operation in the object absent condition.

3) Sensing range for a 2 m 6.562 ft long fiber. A 10 m 32.808 ft long fiber will cause damping of the beam and cannot be used.

4) The fiber cutter is not supplied as an accessory with FT-NB8 and FT-N8. Please order it separately.

FIBER SENSORS

Fiber Selection

Digital Setting

FX-301

FX-302

FX-303

Bank Selection Unit

FX-CH

Manually Set

FX-311

Analog Output

FX-11A

Color Detection

FZ-10

FX-301

LIST OF FIBERS

Sharp bending fibers / Flexible fibers [Thru-beam type (one pair set)]

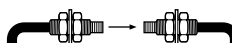

Type	Shape of fiber head (mm in)	Sensing range (mm in) (Note 1)				Min. sensing object (under the optimum) (condition (Note 2))	Fiber cable length (Free-cut)	Allowable bending radius	Model No.	
		Red LED	Blue LED	Green LED	Infrared LED					
Wide beam	Wide area sensing Sensing width 32 mm 1.260 in W5 X H69 X D20 W0.197 X H2.717 X D0.787	3,500 137.795 3,500 137.795 3,500 137.795 (Note 3)	2,400 94.488 1,200 47.244 700 27.559	1,200 47.244 600 23.622 350 13.780	800 31.496 400 15.748 240 9.449	φ 0.3 mm φ 0.012 in opaque object	2 m 6.562 ft	R1 mm R0.039 in	FT-WA30 <i>New</i>	
	Wide area sensing Sensing width 41 mm 0.433 in W4.2 X H31 X D13.5 W0.165 X H1.220 X D0.531	3,500 137.795 1,500 59.055 1,100 43.307 750 29.528	600 23.622 300 11.811 220 8.661	300 11.811 150 5.906 110 4.331	220 8.661 110 4.331 80 3.150	φ 0.25 mm φ 0.010 in opaque object	2 m 6.562 ft	R1 mm R0.039 in	FT-WA8 <i>New</i>	
Rectangular head	Easy mounting · Top sensing W3 X H8 X D12 W0.116 X H0.315 X D0.472	2,500 98.425 1,200 47.244 850 33.465 410 16.142	400 15.748 200 7.874 140 5.512	200 7.874 100 3.937 70 2.756	180 7.087 90 3.543 65 2.559	φ 0.08 mm φ 0.003 in opaque object	2 m 6.562 ft	R1 mm R0.039 in	FT-WZ8H <i>New</i>	
	Easy mounting · Side sensing W3 X H12 X D8 W0.116 X H0.472 X D0.315	1,500 59.055 700 27.559 500 19.685 210 8.268	240 9.449 120 4.724 80 3.150	120 4.724 60 2.362 40 1.575	100 3.937 50 1.969 30 1.181	φ 0.05 mm φ 0.0020 in opaque object			FT-WZ8E <i>New</i>	
	Easy mounting · Front sensing W8.5 X H12 X D3 W0.335 X H0.472 X D0.116	700 27.559 330 12.992 240 9.449 120 4.724	80 3.150 40 1.575 25 0.984	40 1.575 20 0.787 13 0.512	36 1.417 18 0.709 12 0.472	φ 0.04 mm φ 0.0016 in opaque object			FT-WZ8 <i>New</i>	
	Side-view type with small light dispersion φ 4 φ 0.157 φ 3 φ 0.118	1,700 66.929 700 27.559 600 23.622 300 11.811	300 11.811 150 5.906 100 3.937	160 6.299 80 3.150 60 2.362	150 5.906 75 2.953 45 1.772	φ 0.06 mm φ 0.0024 in opaque object			FT-WKV8 <i>New</i>	
Long sensing range	With lens · Long sensing range φ 3 φ 0.118	1,200 47.244 600 23.622 420 16.535 210 8.268	240 9.449 120 4.724 90 3.543	120 4.724 60 2.362 40 1.575	110 4.331 55 2.165 35 1.378	φ 0.02 mm φ 0.0008 in opaque object	2 m 6.562 ft	R1 mm R0.039 in	FT-WS8L	
Standard	Lens mountable M4 φ 3 φ 0.118 φ 2.5 φ 0.098	570 22.441 290 11.417 200 7.874 100 3.937	90 3.543 45 1.772 30 1.181	56 2.205 28 1.102 20 0.787	42 1.654 21 0.827 15 0.591	φ 0.03 mm φ 0.0012 in opaque object	2 m 6.562 ft	R1 mm R0.039 in	FT-W8	
					φ 0.05 mm φ 0.0020 in opaque object	FT-WS3 <i>New</i>				
					φ 0.03 mm φ 0.0012 in opaque object	FT-WS8				
Small diameter	M3 φ 1.5 φ 0.059	160 6.299 80 3.150 55 2.165 28 1.102	16 0.630 8 0.315 5 0.197	10 0.394 5 0.197 3 0.118	8 0.315 4 0.157 2.5 0.098	φ 0.02 mm φ 0.0008 in opaque object	2 m 6.562 ft	R1 mm R0.039 in	FT-W4 FT-WS4	
Side-view	φ 1 φ 0.039 φ 2 φ 0.079 Sleeve part cannot be bent.	90 3.543 40 1.575 30 1.181 15 0.591	— — — —	— — — —	— — — —	φ 0.02 mm φ 0.0008 in opaque object	2 m 6.562 ft	R1 mm R0.039 in	FT-WV42 <i>New</i>	
Rectangular head	Easy mounting · Top sensing W3 X H8 X D12 W0.116 X H0.315 X D0.472	2,700 106.299 1,400 55.118 1,000 39.370 490 19.291	560 22.047 280 11.024 200 7.874	200 7.874 100 3.937 65 2.559	180 7.087 90 3.543 65 2.559	φ 0.03 mm φ 0.0012 in opaque object	2 m 6.562 ft	R4 mm R0.157 in	FT-Z8H	
	Easy mounting · Side sensing W3 X H12 X D8 W0.116 X H0.472 X D0.315	1,600 62.992 800 31.496 600 23.622 280 11.024	400 15.748 200 7.874 140 5.512	200 7.874 100 3.937 65 2.559	140 5.512 70 2.756 50 1.969				FT-Z8E	
	Easy mounting · Front sensing W8.5 X H12 X D3 W0.335 X H0.472 X D0.116	800 31.496 400 15.748 300 11.811 140 5.512	120 4.724 60 2.362 40 1.575	60 2.362 30 1.181 22 0.866	46 1.811 23 0.906 16 0.630				FT-Z8	
Standard	Lens mountable M4	650 25.591 320 12.598 230 9.055 110 4.331	130 5.118 65 2.559 45 1.772	70 2.756 35 1.378 25 0.984	56 2.205 28 1.102 20 0.787	φ 0.04 mm φ 0.0016 in opaque object	2 m 6.562 ft	R4 mm R0.157 in	FT-P80	
	Lens mountable M4	400 15.748 190 7.480 140 5.512 80 3.150	50 1.969 25 0.984 18 0.709	26 1.024 13 0.512 8 0.315	20 0.787 10 0.394 7 0.276				FT-P60 <i>New</i>	
Small diameter	M3 φ 1.5 φ 0.059	250 9.843 100 3.937 75 2.953 35 1.378	32 1.260 16 0.630 12 0.472	18 0.709 9 0.354 7 0.276	14 0.551 7 0.276 5 0.197	φ 0.02 mm φ 0.0008 in opaque object	2 m 6.562 ft	R4 mm R0.157 in	FT-P40	
		280 11.024 120 4.724 90 3.543 42 1.654	36 1.417 18 0.709 14 0.551	20 0.787 10 0.394 8 0.315	18 0.709 9 0.354 7 0.276				1 m 3.281 ft	FT-P2
		80 3.150 40 1.575 30 1.181 17 0.669	14 0.551 7 0.276 4 0.157	6 0.236 3 0.118 2 0.079	14 0.551 7 0.276 4 0.157				500 mm 19.685 in	FT-PS1 <i>New</i>

Notes: 1) Please take care that the sensing range of the free-cut type fiber may be reduced by 20 % max. depending upon how the fiber is cut. In addition, the infrared type is easily affected by humidity, so contact our office if using these sensors in environments with high humidity or where humidity levels can fluctuate.
 2) The minimum sensing object size is the value for red LED type. Please contact our office for information on the minimum sensing object size if using amplifiers other than red LED type. The optimum condition is the condition when the sensitivity is set so that the sensing output just changes to light incident operation in the object absent condition.
 3) The fiber cable length practically limits the sensing range to 3,500 mm (137.795 in) in long.

LIST OF FIBERS

Special use fibers [Thru-beam type (one pair set)]

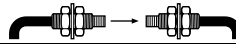

Type	Shape of fiber head (mm in)	Sensing range (mm in) (Note 1)				Min. sensing object (under the optimum) (condition (Note 2))	Fiber cable length (Free-cut)	Allowable bending radius	Model No.
		Red LED	Blue LED	Green LED	Infrared LED				
Wide beam						φ0.3 mm φ0.012 in opaque object	2 m 6.562 ft	R10 mm R0.394 in	FT-A30 <i>New</i>
						φ0.25 mm φ0.010 in opaque object	2 m 6.562 ft	R10 mm R0.394 in	FT-A8
Array	Top sensing 					Horizontal: φ0.025 mm φ0.0010 in opaque object Vertical: φ0.45 mm φ0.018 in opaque object	2 m 6.562 ft	R25 mm R0.984 in	FT-AFM2
	Side sensing 					φ0.45 mm φ0.018 in opaque object	2 m 6.562 ft	R25 mm R0.984 in	FT-AFM2E
Narrow beam						φ0.06 mm φ0.0024 in opaque object	2 m 6.562 ft	R25 mm R0.984 in	FT-K8
	Side-view 					φ0.06 mm φ0.0024 in opaque object	2 m 6.562 ft	R25 mm R0.984 in	FT-KV8
	Side-view 					φ0.02 mm φ0.0008 in opaque object	2 m 6.562 ft	R10 mm R0.394 in	FT-KV1 <i>New</i>
						φ0.02 mm φ0.0008 in opaque object	500 mm 19.685 in	R5 mm R0.197 in	FT-E12
Ultra-small diameter						φ0.02 mm φ0.0008 in opaque object	1 m 3.281 ft	R5 mm R0.197 in	FT-E22
						φ0.02 mm φ0.0008 in opaque object	1 m 3.281 ft	R5 mm R0.197 in	FT-E22
Tough flexible	Lens mountable 					φ0.05 mm φ0.0020 in opaque object	1 m 3.281 ft	R10 mm R0.394 in	FT-P81X <i>New</i>

- Notes: 1) Please take care that the sensing range of the free-cut type fiber may be reduced by 20 % max. depending upon how the fiber is cut. In addition, the infrared type is easily affected by humidity, so contact our office if using these sensors in environments with high humidity or where humidity levels can fluctuate.
- 2) The minimum sensing object size is the value for red LED type. Please contact our office for information on the minimum sensing object size if using amplifiers other than red LED type.
The optimum condition is the condition when the sensitivity is set so that the sensing output just changes to light incident operation in the object absent condition.
- 3) The fiber cable length practically limits the sensing range to 3,500 mm 137.795 in long.

FIBER SENSORS
 Fiber Selection
FX-301
 Digital Setting
 FX-302
 FX-303
 Bank Selection Unit
 FX-CH
 Manually Set
 FX-311
 Analog Output
 FX-11A
 Color Detection
 FZ-10

FX-301

LIST OF FIBERS

Environment resistant fibers [Thru-beam type (one pair set)]



Type	Shape of fiber head (mm in)	Sensing range (mm in) (Note 1)				Min. sensing object (under the optimum) (condition (Note 2))	Fiber cable length (☆: Free-cut)	Allowable bending radius	Model No.
		Red LED	Blue LED	Green LED	Infrared LED				
Environment resistant	350 °C 662 °F Lens mountable 	550 21.654	100 3.937	50 1.969	420 16.535	φ0.04 mm φ0.0016 in opaque object	2 m 6.562 ft	R25 mm R0.984 in	FT-H35-M2
		280 11.024	50 1.969	25 0.984	210 8.268				
	350 °C 662 °F Sleeve 60 mm 2.362 in 	200 7.874	35 1.378	18 0.709	160 6.299	φ0.02 mm φ0.0008 in opaque object	2 m 6.562 ft	Fiber R25 mm R0.984 in Sleeve R10 mm R0.394 in	FT-H35-M2S6
		90 3.543	—	—	—				
	Allows flexible wiring 200 °C 392 °F Lens mountable 	310 12.205	44 1.732	22 0.866	220 8.661	φ0.02 mm φ0.0008 in opaque object	1 m 3.281 ft	R10 mm R0.394 in	FT-H20W-M1
		140 5.512	22 0.866	11 0.433	110 4.331				
	200 °C 392 °F Lens mountable 	550 21.654	100 3.937	50 1.969	420 16.535	φ0.04 mm φ0.0016 in opaque object	1 m 3.281 ft	R25 mm	FT-H20-M1
		280 11.024	50 1.969	25 0.984	210 8.268				
	130 °C 266 °F Lens mountable 	880 34.646	72 2.835	32 1.260	70 2.756	φ0.06 mm φ0.0024 in opaque object	2 m 6.562 ft	R0.984 in	FT-H13-FM2
		440 17.323	36 1.417	16 0.630	35 1.378				
	Easy mounting · Rectangular head SEMI S2 compliant W7 × H15 × D13 W0.276 × H0.591 × D0.512 	3500 137.795	320 12.598	160 6.299	320 12.598	φ4 mm φ0.157 in opaque object	2 m 6.562 ft	R25 mm R0.984 in	FT-Z802Y
		1500 59.055	160 6.299	80 3.150	160 6.299				
Chemical-resistant φ5.5 φ0.217 	3500 137.795	160 6.299	160 6.299	400 15.748	φ0.08 mm φ0.003 in opaque object	2 m 6.562 ft (Note 3)	R30 mm R1.181 in	FT-L8Y	
	1500 59.055	80 3.150	80 3.150	200 7.874					
Side-view φ5.5 φ0.217 	800 31.496	120 4.724	80 3.150	75 2.953	φ0.02 mm φ0.0008 in opaque object	1 m 3.281 ft	R200 mm R7.874 in	FT-V8Y	
	400 15.748	60 2.362	40 1.575	38 1.496					
Vacuum Lens mountable 	470 18.504	100 3.937	46 1.811	70 2.756	φ0.02 mm φ0.0008 in opaque object	1 m 3.281 ft	R200 mm R7.874 in	FT-6V	
	230 9.055	50 1.969	23 0.906	35 1.378					
Vacuum Lens mountable 	165 6.496	30 1.181	16 0.630	22 0.866	φ0.02 mm φ0.0008 in opaque object	1 m 3.281 ft	R30 mm R1.181 in	FT-60V	
	80 3.150	—	—	—					
Vacuum Lens mountable 	220 8.661	36 1.417	18 0.709	28 1.102	φ0.02 mm φ0.0008 in opaque object	1 m 3.281 ft	R30 mm R1.181 in	FT-60V	
	100 3.937	18 0.709	9 0.354	14 0.551					
Vacuum Lens mountable 	75 2.953	12 0.472	6 0.236	10 0.394	φ0.02 mm φ0.0008 in opaque object	1 m 3.281 ft	R30 mm R1.181 in	FT-60V	
	35 1.378	—	—	—					

Notes: 1) Please take care that the sensing range of the free-cut type fiber may be reduced by 20 % max. depending upon how the fiber is cut. In addition, the infrared type is easily affected by humidity, so contact our office if using these sensors in environments with high humidity or where humidity levels can fluctuate.
 2) The minimum sensing object size is the value for red LED type. Please contact our office for information on the minimum sensing object size if using amplifiers other than red LED type. The optimum condition is the condition when the sensitivity is set so that the sensing output just changes to light incident operation in the object absent condition.
 3) The allowable cutting range is 500 mm 19.685 in from the end that the amplifier inserted.

The vacuum type fiber must be used with the following products as a set.

FT-J6: Fiber at atmospheric side (one pair set) FV-BR1: Photo-terminal (one pair set)

Semi-standard fibers (Custom made per order)

The fiber cable length or sleeve length of the standard fibers can be modified at your request. Select the fiber cable length (symbol ☆) or the sleeve length (symbol △) from the table below.

Type	Basic model No.	☆ Fiber cable length (Unit: m ft)	△ Sleeve length (Unit: cm in)
Standard threaded head (free-cut)	FT-FM ☆	3 9.843, 4 13.123, 5 16.404, 10 32.808, 15 49.213, 20 65.617, 25 82.021, 30 98.425	—
	With sleeve FT-FM ☆-S △	2 6.562 (Note), 3 9.843, 4 13.123, 5 16.404, 10 32.808, 15 49.213, 20 65.617, 25 82.021, 30 98.425	1 0.394, 2 0.787, 3 1.181, 4 1.575, 5 1.969, 6 2.362, 7 2.756, 8 3.150, 9 3.543, 10 3.937, 11 4.331, 12 4.724
With large diameter lens	FT-FM ☆ L	20 65.617, 30 98.425	—
Small diameter threaded head with sleeve (free-cut)	FT-NFM2-S △	—	1 0.394, 2 0.787, 3 1.181, 4 1.575, 5 1.969, 6 2.362, 7 2.756, 8 3.150, 9 3.543, 10 3.937, 11 4.331, 12 4.724
Wide beam	FT-WA30- ☆	5 16.404	—
	FT-WA8- ☆		—
	FT-A30- ☆		—
	FT-A8- ☆		—
200°C 392°F heat-resistant	FT-H20-M ☆	2 6.562, 3 9.843	—
350°C 662°F heat-resistant	FT-H35-M ☆	3 9.843	—
Chemical-resistant	FT-Z80 ☆ Y	5 16.404, 7 22.966	—

Correlation between sensing range attenuation coefficient and fiber cable length



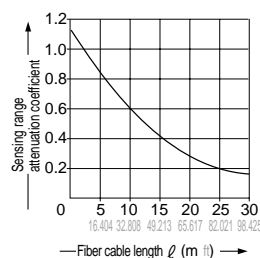







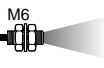



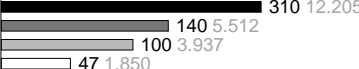

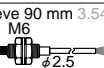



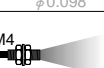



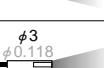



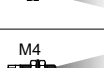

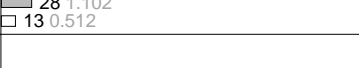
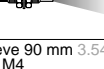

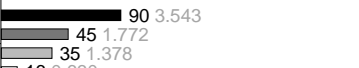
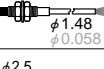
The longer the fiber cable, the shorter the sensing range.

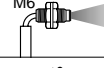

Note: The standard fiber has a 2 m 6.562 ft fiber cable length and a 4 cm 1.575 in or 9 cm 3.543 in sleeve length.

LIST OF FIBERS

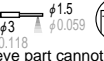
Standard fibers (Reflective type)

Type	Shape of fiber head (mm in)	Sensing range (mm in) (Note 1, 2)				Min. sensing object (at the maximum sensitivity (Note 3))	Fiber cable length ☒ : Free-cut	Allowable bending radius	Model No.	
		Red LED	Blue LED	Green LED	Infrared LED					
Standard	 M6 Long sensing range	 480 18.898 220 8.661 160 6.299 75 2.953	80 3.150 40 1.575 26 1.024	42 1.654 21 0.827 14 0.551	26 1.654 13 0.827 9 0.551	φ0.02 mm φ0.0008 in gold wire	 2 m 6.562 ft	R25 mm R0.984 in	FD-B8	
		 Coaxial M6	 310 12.205 140 5.512 100 3.937 47 1.850	46 1.811 23 0.906 15 0.591	24 0.945 12 0.472 8 0.315	90 3.543 45 1.772 30 1.181	φ0.02 mm φ0.0008 in gold wire	500 mm 19.685 in	R25 mm R0.984 in	FD-5
			 310 12.205 140 5.512 100 3.937 47 1.850	46 1.811 23 0.906 15 0.591	24 0.945 12 0.472 8 0.315	20 0.787 10 0.394 7 0.276		 2 m 6.562 ft		FD-FM2
		 Sleeve 90 mm 3.543 in M6 φ2.5 φ0.098	 270 10.630 110 4.331	46 1.811 23 0.906 15 0.591	24 0.945 12 0.472 8 0.315	20 0.787 10 0.394 7 0.276	φ0.02 mm φ0.0008 in gold wire	 2 m 6.562 ft	Fiber R25 mm R0.984 in Sleeve R10 mm R0.394 in	FD-FM2S
	 85 3.346 39 1.535		46 1.811 23 0.906 15 0.591	24 0.945 12 0.472 8 0.315	20 0.787 10 0.394 7 0.276	FD-FM2S4				
	 M4	 270 10.630 110 4.331 85 3.346 39 1.535	46 1.811 23 0.906 15 0.591	24 0.945 12 0.472 8 0.315	20 0.787 10 0.394 7 0.276	φ0.02 mm φ0.0008 in gold wire	 2 m 6.562 ft	R25 mm R0.984 in	FD-T80	
		 90 3.543 45 1.772 35 1.378 16 0.630	16 0.630 8 0.315 5 0.197	8 0.315 4 0.157 2 0.079	6 0.236 3 0.118 2 0.079			FD-T40		
	 Small diameter M3 φ3 φ0.118	 270 10.630 110 4.331 85 3.346 39 1.535	46 1.811 23 0.906 15 0.591	24 0.945 12 0.472 8 0.315	20 0.787 10 0.394 7 0.276	φ0.02 mm φ0.0008 in gold wire	 2 m 6.562 ft	R25 mm R0.984 in	FD-S80	
		 260 10.236 120 4.724 85 3.346 42 1.654	46 1.811 23 0.906 15 0.591	24 0.945 12 0.472 8 0.315	20 0.787 10 0.394 7 0.276			FD-N8		
	 M4	 75 2.953 38 1.496 28 1.102 13 0.512	16 0.630 8 0.315 5 0.197	8 0.315 4 0.157 2 0.079	4 0.157 2 0.079 1.5 0.059	φ0.02 mm φ0.0008 in gold wire	 2 m 6.562 ft (Note 4)	R25 mm R0.984 in	FD-N4	
		 90 3.543 45 1.772 35 1.378 16 0.630	16 0.630 8 0.315 5 0.197	8 0.315 4 0.157 2 0.079	6 0.236 3 0.118 2 0.079			FD-NFM2		
	 Sleeve 90 mm 3.543 in M4 φ1.48 φ0.058	 90 3.543 45 1.772	16 0.630 8 0.315 5 0.197	8 0.315 4 0.157 2 0.079	6 0.236 3 0.118 2 0.079	φ0.02 mm φ0.0008 in gold wire	 2 m 6.562 ft	Fiber R25 mm R0.984 in Sleeve R10 mm R0.394 in	FD-NFM2S	
		 35 1.378 16 0.630	16 0.630 8 0.315 5 0.197	8 0.315 4 0.157 2 0.079	6 0.236 3 0.118 2 0.079			FD-NFM2S4		
	 Sleeve 40 mm 1.575 in M4 φ1.48 φ0.058	 16 0.630	16 0.630 8 0.315 5 0.197	8 0.315 4 0.157 2 0.079	6 0.236 3 0.118 2 0.079	φ0.02 mm φ0.0008 in gold wire	 2 m 6.562 ft	R25 mm R0.984 in	FD-SNFM2	
		 185 7.283 85 3.346 60 2.362 30 1.181	32 1.260 16 0.630 10 0.394	16 0.630 8 0.315 5 0.197	10 0.472 5 0.197 3 0.118			FD-R80		
	 Elbow M6	 100 3.937 45 1.772 32 1.260 16 0.630	14 0.551 7 0.276 4 0.157	7 0.276 3.5 0.138	4 0.157	φ0.02 mm φ0.0008 in gold wire	 2 m 6.562 ft	R25 mm R0.984 in	FD-R80	
		 55 2.165 25 0.984 17 0.669 9 0.354	6 0.236 3 0.118	3 0.118	3 0.118			FD-SFM2SV2		
	 Side-view Small diameter φ1.5 φ0.059 φ0.118 φ0.028 Sleeve part cannot be bent.	 9 0.354	9 0.354	9 0.354	9 0.354	φ0.02 mm φ0.0008 in gold wire	 2 m 6.562 ft	R25 mm R0.984 in	FD-V41	

Notes: 1) The sensing range is specified for white non-glossy paper (FD-B8, FD-5, FD-FM2, FD-FM2S, FD-FM2S4, FD-N8, FD-T80, FD-S80 and FD-R80: 400 × 400 mm 15.748 × 15.748 in, FD-T40, FD-N4, FD-NFM2, FD-NFM2S, FD-NFM2S4, FD-SNFM2, FD-SFM2SV2 and FD-V41: 200 × 200 mm 7.874 × 7.874 in) as the object.

2) Please take care that the sensing range of the free-cut type fiber may be reduced by 20 % max. depending upon how the fiber is cut. In addition, the infrared type is easily affected by humidity, so contact our office if using these sensors in environments with high humidity or where humidity levels can fluctuate.

3) The minimum sensing object size is the value for red LED type at maximum sensitivity. Please contact our office for information on the minimum sensing object size if using amplifiers other than red LED type.

Also, note that the corresponding setting distance is different from the rated sensing distance.

4) The fiber cutter is not supplied as an accessory with FD-N8 and FD-N4. Please order it separately.

FX-301

LIST OF FIBERS

Sharp bending fibers / Flexible fibers (Reflective type)





Type	Shape of fiber head (mm in)	Sensing range (mm in) (Note 1, 2)				Min. sensing object (at the maximum sensitivity (Note 3))	Fiber cable length ✂: Free-cut	Allowable bending radius	Model No.				
		Red LED	Blue LED	Green LED	Infrared LED								
Sharp bending	Long sensing range - Rectangular head W162xH95xD15 mm W0.205xH0.374xD0.591 in	20 to 480 0.787 to 18.898 20 to 230 0.787 to 9.055 20 to 170 0.787 to 6.693 25 to 100 0.984 to 3.937	—	—	—	φ 0.3 mm φ 0.012 in copper wire	2 m 6.562 ft	R1 mm R0.039 in	FD-WKZ1 <i>New</i>				
	M6	190 7.480 90 3.543 60 2.362 32 1.260	23 0.906 11 0.433 8 0.315	14 0.551 7 0.276 4 0.157	11 0.433 5.5 0.217 3 0.118	φ 0.02 mm φ 0.0008 in gold wire	2 m 6.562 ft	R1 mm R0.039 in	FD-W8				
	Sleeve 40 mm 1.575 in M4 φ 1.48 φ 0.058	30 1.181 15 0.591 12 0.472 5 0.197	5 0.197 2.5 0.098 1.5 0.059	3 0.118 1.5 0.059 1 0.039	2 0.079 1 0.039				Fiber R1 mm R0.039 in Sleeve R10 mm R0.394 in	FD-W44			
	M4	190 7.480 90 3.543 60 2.362 32 1.260	23 0.906 11 0.433 8 0.315	14 0.551 7 0.276 4 0.157	11 0.433 5.5 0.217 3 0.118				R1 mm R0.039 in	FD-WT8			
	φ 3 φ 0.118	30 1.181 15 0.591 12 0.472 5 0.197	5 0.197 2.5 0.098 1.5 0.059	3 0.118 1.5 0.059 1 0.039	2 0.079 1 0.039					FD-WS8			
	M3	30 1.181 15 0.591 12 0.472 5 0.197	5 0.197 2.5 0.098 1.5 0.059	3 0.118 1.5 0.059 1 0.039	2 0.079 1 0.039					FD-WT4			
	High precision	Small spot for sensing minute objects Coaxial · Lens mountable M4 For sensing minute objects · Coaxial φ 3 φ 0.118	65 2.559 32 1.260 25 0.984 11 0.433	11 0.433 5 0.197 3 0.118	6 0.236 3 0.118 2 0.079				5 0.197 2.5 0.098 1.5 0.059	φ 0.02 mm φ 0.0008 in gold wire	2 m 6.562 ft	R2 mm R0.079 in	FD-WG4
	Fixed-focus reflective	Glass substrate detection W24 × H21 × D4 W0.945 × H0.827 × D0.157 7.5 to 12 0.295 to 0.472 (Convergent point 8 0.315) Cannot use	6.5 to 14 0.256 to 0.551 (Convergent point 8 0.315) 7 to 12 0.276 to 0.472 (Convergent point 8 0.315) Cannot use	—	—				—				φ 1.9 mm φ 0.075 in metal pipe (gray)
	Specular object detection W15 × H19 × D3 W0.591 × H0.748 × D0.118	0.6 to 3.5 0.024 to 0.138 (Convergent point 2 0.079) 0.9 to 2.7 0.035 to 0.106 (Convergent point 2 0.079) Cannot use	—	—	—				—	φ 0.08 mm φ 0.003 in gold wire	—	—	FD-WL42 <i>New</i>
	Side-view φ 2 φ 3 φ 0.079 φ 0.118 0.039 Sleeve part cannot be bent.	15 0.591 7 0.276 5 0.197 Cannot use	—	—	—				—	φ 0.02 mm φ 0.0008 in gold wire	2 m 6.562 ft	R1 mm R0.039 in	FD-WV42 <i>New</i>
	Flexible	Standard	M6 220 8.661 100 3.937 70 2.756 35 1.378	40 1.575 20 0.787 13 0.512	20 0.787 10 0.394 7 0.276				18 0.709 9 0.354 6 0.236	φ 0.02 mm φ 0.0008 in gold wire	2 m 6.562 ft	R4 mm R0.157 in	FD-P80
		M4	90 3.543 45 1.772 30 1.181 16 0.630	20 0.787 10 0.394 6 0.236	10 0.394 5 0.197 3 0.118				8 0.315 4 0.157 2.5 0.098				FD-P60
φ 3 φ 0.118		36 1.417 18 0.709 14 0.551 6 0.236	5 0.197 2.5 0.098 1.5 0.059	3 0.118 1.5 0.059 1 0.039	2 0.079 1 0.039				FD-P50				
M3		50 1.969 25 0.984 19 0.748 9 0.354	8 0.315 4 0.157 2.5 0.098	4 0.157 2 0.079 1.5 0.059	7 0.276 3.5 0.138 2 0.079	FD-P40							
Small diameter		φ 1.5 φ 0.059	—	—	—	—	1 m 3.281 ft	—	FD-P2				

- Notes: 1) The sensing range is specified for white non-glossy paper [100 × 100 mm 3.937 × 3.937 in (FD-WKZ1, FD-W8, FD-WT8, FD-WS8 and FD-P80: 400 × 400 mm 15.748 × 15.748 in, FD-WG4, FD-WSG4, FD-P60 and FD-P50: 200 × 200 mm 7.874 × 7.874 in, FD-WL41: glass substrate 100 × 100 × t 2 mm 3.937 × 3.937 × t 0.472 in)] as the object.
- 2) Please take care that the sensing range of the free-cut type fiber may be reduced by 20 % max. depending upon how the fiber is cut. In addition, the infrared type is easily affected by humidity, so contact our office if using these sensors in environments with high humidity or where humidity levels can fluctuate.
- 3) The minimum sensing object size is the value for red LED type at maximum sensitivity. Please contact our office for information on the minimum sensing object size if using amplifiers other than red LED type.
- Also, note that the corresponding setting distance is different from the rated sensing distance. However, with the fixed-focus reflective type, when the sensitivity is at MAX., it is only possible to detect the minimum size of the sensing object at a distance corresponding to the convergent point.

LIST OF FIBERS

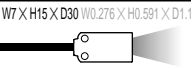
Special use fibers (Reflective type)

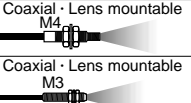
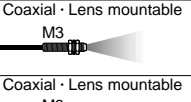
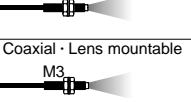
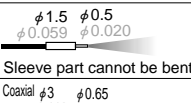
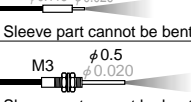
Type	Shape of fiber head (mm in)	Sensing range (mm in) (Note 1, 2)				Min. sensing object (at the maximum) (sensitivity (Note 3))	Fiber cable length (Note 4)	Allowable bending radius	Model No.		
		Red LED	Blue LED	Green LED	Infrared LED						
Special use	Wide beam 	W7 X H15 X D30 (W0.276 X H0.591 X D1.181)	200 7.874 150 5.906 100 3.937 50 1.969	25 0.984 15 0.591	—	—	φ0.02 mm φ0.0008 in gold wire	2 m 6.562 ft	R25 mm R0.984 in	FD-A15 <i>New</i>	
		Array 	Top sensing W5 X H20 X D20 (W0.197 X H0.787 X D0.787)	220 8.661 110 4.331 78 3.071	40 1.575 20 0.787 13 0.512	18 0.709 9 0.354 5 0.197	12 0.472 6 0.236 4 0.157	φ0.02 mm φ0.0008 in gold wire	2 m 6.562 ft	R25 mm R0.984 in	FD-AFM2 FD-AFM2E
	Side sensing W5 X H20 X D20 (W0.197 X H0.787 X D0.787)		39 1.535	—	—	—	—	—	—	—	
	High precision 	Coaxial · Lens mountable M4	110 4.331 55 2.165 42 1.654	22 0.866 11 0.433 8 0.315	12 0.472 6 0.236 4 0.157	7 0.276 3.5 0.138 2 0.079	φ0.02 mm φ0.0008 in gold wire	2 m 6.562 ft	R25 mm R0.984 in	FD-G4 FD-G6 <i>New</i>	
		Coaxial · Lens mountable M3	38 1.496 18 0.709 14 0.551 6 0.236	6 0.236 3 0.118 2 0.079	3 0.118 1.5 0.059 1 0.039	10 0.394 5 0.197 3 0.118	—	—	—	—	
		Coaxial · Lens mountable M3	25 0.984 12 0.472 9 0.354 5 0.197	5 0.197 2 0.079 1 0.039	2 0.079 1 0.039	6 0.236 3 0.118 2 0.079	φ0.04 mm φ0.0016 in gold wire	500 mm 19.685 in	R10 mm R0.394 in	FD-EG1 FD-EG2 <i>New</i> FD-EG3 <i>New</i>	
		Coaxial · Lens mountable M3	15 0.591 8 0.315 5 0.197 3 0.118	2 0.079 1 0.039	1 0.039	3 0.118 1.5 0.059 1 0.039	—	—	—	—	
		Ultra-small diameter 	φ1.5 φ0.5 φ0.059 φ0.020	11 0.433 6 0.236 4 0.157 1 0.039	2 0.079 1 0.039	1 0.039	—	—	—	—	—
			Sleeve part cannot be bent.	45 1.772 23 0.906 17 0.669 7 0.276	6 0.236 3 0.118 2 0.079	3 0.118 1.5 0.059 1 0.039	6 0.236 3 0.118 2 0.079	φ0.02 mm φ0.0008 in gold wire	1 m 3.281 ft	R10 mm R0.394 in	FD-E12 FD-E22
	Coaxial φ3 φ0.65 φ0.118 φ0.026		5 0.197 3 0.118 2 0.079	—	—	—	—	—	—	—	
	Sleeve part cannot be bent.		5 0.197 3 0.118 2 0.079	—	—	—	—	—	—	—	
	M3 φ0.5 φ0.020		38 1.496 18 0.709 14 0.551 6 0.236	6 0.236 3 0.118 2 0.079	3 0.118 1.5 0.059 1 0.039	4 0.157 2 0.079 1.5 0.059	—	—	—	—	
	Coaxial φ0.8 φ0.031		18 0.709 14 0.551 6 0.236	6 0.236 3 0.118 2 0.079	3 0.118 1.5 0.059 1 0.039	4 0.157 2 0.079 1.5 0.059	—	—	—	—	
	Sleeve part cannot be bent.	—	—	—	—	—	—	—	—		
	Fixed-focus reflective 	Glass substrate detection- SEMI S2 compliant W17 X H29 X D3.8 (W0.669 X H1.142 X D0.150)	0 to 20 0 to 0.787	—	—	—	(LCD glass)	—	R4 R0.157	FD-L43	
		Glass substrate detection W24 X H21 X D4 (W0.945 X H0.827 X D0.157)	2.5 to 18 0.098 to 0.709 (Convergent point 8 0.315) 3 to 16 0.118 to 0.630 (Convergent point 8 0.315) 3.5 to 15 0.138 to 0.591 (Convergent point 8 0.315) Cannot use	—	—	—	φ0.06 mm φ0.0024 in gold wire	2 m 6.562 ft	R10 mm R0.394 in	FD-L41 FD-L42	
		Specular object detection- W15 X H19 X D3 (W0.591 X H0.748 X D0.118)	0.5 to 4 0.020 to 0.157 (Convergent point 2 0.079) 1 to 3.8 0.039 to 0.150 (Convergent point 2 0.079) 1.3 to 3.5 0.051 to 0.138 (Convergent point 2 0.079) Cannot use	—	—	—	φ0.03 mm φ0.0012 in gold wire	—	—	—	
		W6 X H18 X D14 (W0.236 X H0.709 X D0.551)	2.5 to 18 0.098 to 0.709 (Convergent point 6 0.236) 4 to 12 0.157 to 0.472 (Convergent point 6 0.236) 4.5 to 11 0.177 to 0.433 (Convergent point 6 0.236) 4.8 to 9.5 0.189 to 0.374 (Convergent point 6 0.236)	45 to 45 0.177 to 0.374 5 to 9 0.197 to 0.354 55 to 8 0.227 to 0.315	—	—	—	φ0.02 mm φ0.0008 in gold wire	—	—	FD-L4
	Liquid level sensing 	Contact type φ6 φ0.236	—	—	—	—	(Liquid)	2 m 6.562 ft (Note 4)	Protective tube R40 mm R1.575 in Fiber R15 mm R0.591 in	FD-F8Y	
		Mountable on pipe · Standard W25 X H13 X D20 (W0.984 X H0.512 X D0.787)	Applicable pipe diameter: Outer dia. φ6 to φ26 mm φ0.236 to φ1.024 in transparent pipe [PVC, fluorine resin, polycarbonate, acrylic, glass, wall thickness 1 to 3 mm 0.039 to 0.118 in]	—	—	—	—	(Liquid)	2 m 6.562 ft 5 m 16.404 ft	R10 mm R0.394 in	FD-F41 FD-F91
Mountable on pipe · For PFA, wall thickness 1 mm 0.039 in pipe W25 X H13 X D20 (W0.984 X H0.512 X D0.787)			Applicable pipe diameter: Outer dia. φ6 to φ26 mm φ0.236 to φ1.024 in transparent pipe [PFA (fluorine resin) or equivalently transparent pipe, wall thickness 1 mm 0.039 in]	—	—	—	—	(Liquid)	2 m 6.562 ft 5 m 16.404 ft	—	FD-F4 FD-F9
			—	—	—	—	—	—	—	—	—
Tough flexible 	M6	185 7.283 80 3.150 60 2.362 35 1.378	32 1.260 16 0.630 10 0.394	16 0.630 8 0.315 5 0.197	30 1.181 15 0.591 10 0.394	φ0.02 mm φ0.0008 in gold wire	1 m 3.281 ft	R10 mm R0.394 in	FD-P81X <i>New</i>		
	Small spot for sensing minute objects M3	90 3.543 45 1.772 35 1.378 20 0.787	22 0.866 11 0.433 6 0.236	12 0.472 6 0.236 4 0.157	18 0.709 9 0.354 5 0.197	—	—	—	—		
Coaxial · High precision	—	—	—	—	—	—	—	—	FD-G6X <i>New</i>		

Notes: 1) The sensing range is specified for white non-glossy paper [100 X 100 mm 3.937 X 3.937 in (FD-A15, FD-G4, FD-G6X: 200 X 200 mm 7.874 X 7.874 in, FD-AFM2, FD-AFM2E, FD-P81X: 400 X 400 mm 15.748 X 15.748 in, FD-L43: glass substrate 76 X 52 X t 1.1 mm 2.992 X 2.047 X t 0.043 in, FD-L41: glass substrate 100 X 100 X t 2 mm 3.937 X 3.937 X t 0.079 in)] as the object.

2) Please take care that the sensing range of the free-cut type fiber may be reduced by 20 % max. depending upon how the fiber is cut. In addition, the infrared type is easily affected by humidity, so contact our office if using these sensors in environments with high humidity or where humidity levels can fluctuate.

3) The minimum sensing object size is the value for red LED type at maximum sensitivity. Please contact our office for information on the minimum sensing object size if using amplifiers other than red LED type.

Also, note that the corresponding setting distance is different from the rated sensing distance. However, with the fixed-focus reflective type, when the sensitivity is at MAX., it is only possible to detect the minimum size of the sensing object at a distance corresponding to the convergent point.









4) Following is the allowable cutting range from the end that the amplifier is inserted FD-F8Y: 1,000 mm 39.370 in, FD-G6X: 700 mm 27.559 in.

FX-301

LIST OF FIBERS

Environment resistant fibers (Reflective type)



Type	Shape of fiber head (mm in)	Sensing range (mm in) (Note 1, 2)				Min. sensing object (at the maximum sensitivity) (Note 3)	Fiber cable length (Free-cut)	Allowable bending radius	Model No.
		Red LED	Blue LED	Green LED	Infrared LED				
Environment resistant	350 °C 662 °F · Coaxial 						2 m 6.562 ft	R25 mm R0.984 in	FD-H35-M2
	350 °C 662 °F · Sleeve 60 mm 2.362 in 	270 10.630 140 5.512 100 3.937 47 1.850	36 1.417 18 0.709 12 0.472	20 0.787 10 0.394 7 0.276	140 5.512 70 2.756 45 1.772	φ0.02 mm φ0.0008 in gold wire		Fiber R25 mm R0.984 in Sleeve R10 mm R0.394 in	FD-H35-M2S6
	200 °C 392 °F · Coaxial 						1 m 3.281 ft	R25 mm R0.984 in	FD-H20-M1
	350 °C 662 °F · Sleeve 90 mm 3.543 in 	160 6.299 80 3.150 57 2.244 26 1.024	22 0.866 11 0.433 7 0.276	12 0.472 6 0.236 4 0.157	80 3.150 40 1.575 28 1.102	φ0.02 mm φ0.0008 in gold wire		Fiber R25 mm R0.984 in Sleeve R10 mm R0.394 in	FD-H35-20S <i>New</i>
	200 °C 392 °F · Coaxial 	270 10.630 140 5.512 100 3.937 47 1.850	36 1.417 18 0.709 12 0.472	20 0.787 10 0.394 7 0.276	140 5.512 70 2.756 45 1.772	φ0.02 mm φ0.0008 in gold wire		R25 mm R0.984 in	FD-H20-21 <i>New</i>
	300 °C 572 °F · Glass substrate detection Fixed-focus reflective type 	0 to 15 0 to 0.591 0 to 10 0 to 0.394 1 to 8 0.039 to 0.315 2 to 6 0.079 to 0.236	—	—	—	φ0.02 mm φ0.0008 in gold wire	2 m 6.562 ft	R25 mm R0.984 in	FD-H30-L32 <i>New</i>
	180 °C 356 °F · Glass substrate detection Fixed-focus reflective type 	—	—	—	—	φ0.02 mm φ0.0008 in gold wire	2 m 6.562 ft	R25 mm R0.984 in	FD-H18-L31 <i>New</i>
	130 °C 266 °F 	310 12.205 140 5.512 100 3.937 47 1.850	20 0.787 11 0.433 7 0.276	20 0.787 11 0.433 7 0.276	25 0.984 12 0.472 8 0.315	φ0.02 mm φ0.0008 in gold wire		R25 mm R0.984 in	FD-H13-FM2
	Vacuum 	165 6.496 75 2.953 52 2.047 26 1.024	26 1.024 13 0.512 9 0.354	14 0.551 7 0.276 4 0.157	21 0.827 10 0.394 6 0.236	φ0.02 mm φ0.0008 in gold wire		R200 mm R7.874 in	FD-6V

Notes: 1) The sensing range is specified for white non-glossy paper [400 X 400 mm 15.748 X 15.748 in (FD-H30-L32, FD-H18-L31: glass substrate 50 X 50 mm 1.969 X 1.969 in)] as the object.
 2) Please take care that the sensing range of the free-cut type fiber may be reduced by 20 % max. depending upon how the fiber is cut. In addition, the infrared type is easily affected by humidity, so contact our office if using these sensors in environments with high humidity or where humidity levels can fluctuate.
 3) The minimum sensing object size is the value for red LED type at maximum sensitivity. Please contact our office for information on the minimum sensing object size if using amplifiers other than red LED type. Also, note that the corresponding setting distance is different from the rated sensing distance.

The vacuum type fiber must be used with the following products as a set.

- FT-J6: Fiber at atmospheric side (one pair set)
- FV-BR1: Photo-terminal (one pair set)

Semi-standard fibers (Custom made per order)

The fiber cable length or sleeve length of the standard fibers can be modified at your request. Select the fiber cable length (symbol ☒) or the sleeve length (symbol ☐) from the table below.

Type	Basic model No.	☒ Fiber cable length (Unit: m ft)	☐ Sleeve length (Unit: cm in)
Standard threaded head (free-cut)	FD-FM ☒	3 9.843, 4 13.123, 5 16.404, 10 32.808, 15 49.213, 20 65.617	—
With sleeve	FD-FM ☒-S ☐	2 6.562 (Note), 3 9.843, 4 13.123, 5 16.404, 10 32.808, 15 49.213, 20 65.617	1 0.394, 2 0.787, 3 1.181, 4 1.575, 5 1.969, 6 2.362, 7 2.756, 8 3.150, 9 3.543, 10 3.937, 11 4.331, 12 4.724
Small diameter threaded head with sleeve (free-cut)	FD-NFM2-S ☐	—	1 0.394, 2 0.787, 3 1.181, 4 1.575, 5 1.969, 6 2.362, 7 2.756, 8 3.150, 9 3.543, 10 3.937, 11 4.331, 12 4.724
200°C 392°F heat-resistant	FD-H20-M ☒	2 6.562, 3 9.843	—
350°C 662°F heat-resistant	FD-H35-M ☒	3 9.843	—

Note: The standard fiber has a 2 m 6.562 ft fiber cable length and a 4 cm 1.575 in or 9 cm 3.543 in sleeve length.

Correlation between sensing range attenuation coefficient and fiber cable length

The longer the fiber cable, the shorter the sensing range.

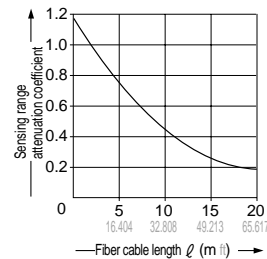

Accessories (attached with fibers)

Fiber cutter

- FX-CT2

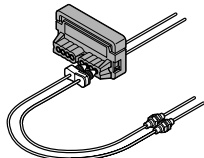

Fiber attachment

- FX-AT2 (for fixed-length fiber)
- FX-AT3 (for φ2.2 mm φ0.087 in fiber)
- FX-AT4 (for φ1 mm φ0.039 in fiber)
- FX-AT5 (for φ1.3 mm φ0.051 in fiber)
- FX-AT6 (for φ1 mm φ0.039 in and φ1.3 mm φ0.051 in mixed fiber)

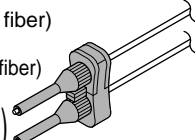
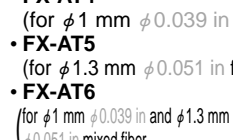
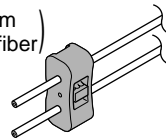
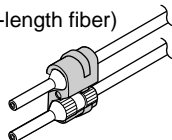

Notes: 1) Fiber cutter is not supplied as accessory along with FT-NB8, FT-N8, FD-N8 and FD-N4. Please order it separately.
 2) The fiber attachment is not attached with FT-N8/NB8/P80 and FD-N8/P80. The previous FX-AT10 attachment is attached with FD-N4.

FIBER OPTIONS

Lens (For thru-beam type fiber)

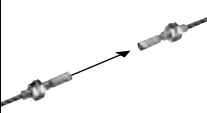
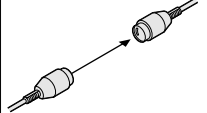
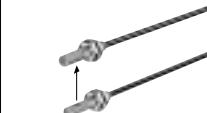
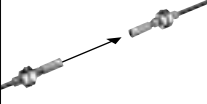
Designation	Model No.	Description	
For thru-beam type fiber	Expansion lens (Note 1)	FX-LE1	 <p>Increases the sensing range by 5 times or more.</p> <ul style="list-style-type: none"> Ambient temperature: <ul style="list-style-type: none"> - 60 to + 350 °C - 76 to + 662 °F
	Super-expansion lens (Note 1)	FX-LE2	 <p>Tremendously increases the sensing range with large diameter lenses.</p> <ul style="list-style-type: none"> Ambient temperature: <ul style="list-style-type: none"> - 60 to + 350 °C - 76 to + 662 °F
	Side-view lens	FX-SV1	 <p>Beam axis is bent by 90°.</p> <ul style="list-style-type: none"> Ambient temperature: <ul style="list-style-type: none"> - 60 to + 300 °C - 76 to + 572 °F
	Expansion lens for vacuum fiber (Note 1)	FX-LE1	 <p>Sensing range increases by 15 times or more.</p> <ul style="list-style-type: none"> Ambient temperature: <ul style="list-style-type: none"> - 40 to + 120 °C - 40 to + 248 °F

Sensing range (mm) [Lens on both sides] (Note 2)				
Fiber	Mode	LONG	STD	S-D
FT-B8		3,500 (Note 3)	2,500	2,000
FT-FM2		3,500 (Note 3)	3,500 (Note 3)	2,500
FT-T80		3,500 (Note 3)	3,500 (Note 3)	2,500
FT-R80		3,500 (Note 3)	2,300	1,600
FT-W8		3,500 (Note 3)	2,900	2,000
FT-P80		3,500 (Note 3)	3,500 (Note 3)	2,500
FT-P60		3,500 (Note 3)	3,500 (Note 3)	1,500
FT-P81X		3,500 (Note 3)	3,500 (Note 3)	2,500
FT-H35-M2		3,500 (Note 3)	2,000	1,500
FT-H20W-M1		1,600 (Note 3)	1,300	900
FT-H20W-M2		2,600	1,300	900
FT-H20-M1		1,600 (Note 3)	1,600 (Note 3)	1,100

Sensing range (mm) [Lens on both sides] (Note 2)				
Fiber	Mode	LONG	STD	S-D
FT-B8		3,500 (Note 3)	3,500 (Note 3)	3,500 (Note 3)
FT-FM2		3,500 (Note 3)	3,500 (Note 3)	3,500 (Note 3)
FT-R80		3,500 (Note 3)	3,500 (Note 3)	3,500 (Note 3)
FT-W8		3,500 (Note 3)	3,500 (Note 3)	3,500 (Note 3)
FT-P80		3,500 (Note 3)	3,500 (Note 3)	3,500 (Note 3)
FT-P60		3,500 (Note 3)	3,500 (Note 3)	3,500 (Note 3)
FT-P81X		3,500 (Note 3)	3,500 (Note 3)	3,500 (Note 3)
FT-H35-M2		3,500 (Note 3)	3,500 (Note 3)	3,500 (Note 3)
FT-H20W-M1		1,600 (Note 3)	1,600 (Note 3)	1,600 (Note 3)
FT-H20W-M2		3,500 (Note 3)	3,500 (Note 3)	3,000
FT-H20-M1		1,600 (Note 3)	1,600 (Note 3)	1,600 (Note 3)
FT-H13-FM2		3,500 (Note 3)	3,500 (Note 3)	3,500 (Note 3)

Sensing range (mm) [Lens on both sides] (Note 2)				
Fiber	Mode	LONG	STD	S-D
FT-B8		1,100	530	400
FT-FM2		1,200	600	440
FT-T80		1,200	600	440
FT-W8		900	450	330
FT-P80		1,200	600	440
FT-P60		650	300	200
FT-P81X		1,200	600	440
FT-H35-M2		550	280	200
FT-H20W-M1		310	140	100
FT-H20W-M2		310	140	100
FT-H20-M1		550	280	200

Sensing range (mm) [Lens on both sides] (Note 2)				
Fiber	Mode	LONG	STD	S-D
FT-6V		3,500 (Note 3)	2,700	1,800
FT-60V		2,800	1,450	1,000

Notes: 1) Be careful when installing the thru-beam type fiber equipped with the expansion lens, as the beam envelope becomes narrow and alignment is difficult. Especially when installing a fiber with many cores (sharp bending fibers and heat-resistant glass fiber) please be sure to use it only after you have adjusted it sufficiently.
 2) The sensing ranges are the values for red LED type amplifier. Please contact our office for details on sensing ranges for other types of amplifiers.
 3) The fiber cable length practically limits the sensing range to 3.500 mm 137.795 in long (FT-H20W-M1 and FT-H20-M1: 1,600 mm 62.992 in).

Lens (For reflective type fiber)

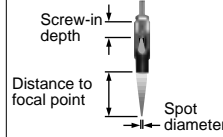
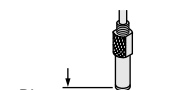
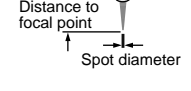
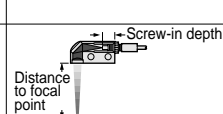
Designation	Model No.	Description		
Pinpoint spot lens	FX-MR1		<p>Pinpoint spot of $\phi 0.5$ mm $\phi 0.020$ in. Enables detection of minute objects or small marks.</p> <ul style="list-style-type: none"> Applicable fibers: FD-WG4, FD-G4 • Distance to focal point: 6 ± 1 mm 0.236 ± 0.039 in Ambient temperature: - 40 to + 70 °C - 40 to + 158 °F 	
For reflective type fiber	Zoom lens	FX-MR2	 <p>The spot diameter is adjustable from $\phi 0.7$ mm $\phi 0.028$ in to $\phi 2$ mm $\phi 0.079$ in according to how much the fiber is screwed in.</p> <ul style="list-style-type: none"> Applicable fibers: FD-WG4, FD-G4 Ambient temperature: - 40 to + 70 °C - 40 to + 158 °F Accessory: MS-EX-3 (mounting bracket) 	
	Finest spot lens	FX-MR3	 <p>Extremely fine spot of $\phi 0.3$ mm $\phi 0.012$ in approx. achieved.</p> <ul style="list-style-type: none"> Applicable fibers: FD-WG4, FD-G4, FD-EG1, FD-EG2, FD-EG3, FD-G6X, FD-G6 Ambient temperature: - 40 to + 70 °C - 40 to + 158 °F 	
	Finest spot lens	FX-MR6	 <p>Extremely fine spot of $\phi 0.1$ mm $\phi 0.004$ in approx. achieved.</p> <ul style="list-style-type: none"> Applicable fibers: FD-WG4, FD-G4, FD-EG1, FD-EG2, FD-EG3, FD-G6X, FD-G6 Ambient temperature: - 20 to + 60 °C - 4 to + 140 °F 	
	Zoom lens (Side-view type)	FX-MR5		<p>FX-MR2 is converted into a side-view type and can be mounted in a very small space.</p> <ul style="list-style-type: none"> Applicable fibers: FD-WG4, FD-G4 Ambient temperature: - 40 to + 70 °C - 40 to + 158 °F

Sensing range (Note 1)		
Screw-in depth	Distance to focal point	Spot diameter
7 mm	$\phi 18.5$ mm approx.	$\phi 0.7$ mm
12 mm	$\phi 27$ mm approx.	$\phi 1.2$ mm
14 mm	$\phi 43$ mm approx.	$\phi 2.0$ mm

Sensing range (Note 1)		
Fiber	Distance to focal point	Spot diameter
FD-EG3	7.5 ± 0.5 mm	$\phi 0.15$ mm approx.
FD-EG2	7.5 ± 0.5 mm	$\phi 0.2$ mm approx.
FD-EG1	7.5 ± 0.5 mm	$\phi 0.3$ mm approx.
FD-WG4/G4/G6X/G6	7.5 ± 0.5 mm	$\phi 0.5$ mm approx.

Sensing range (Note 1)		
Fiber	Distance to focal point	Spot diameter
FD-EG3	7 ± 0.5 mm	$\phi 0.1$ mm approx.
FD-EG2	7 ± 0.5 mm	$\phi 0.15$ mm approx.
FD-EG1	7 ± 0.5 mm	$\phi 0.2$ mm approx.
FD-WG4/G4/G6X/G6	7 ± 0.5 mm	$\phi 0.4$ mm approx.

Sensing range (Note 1)		
Screw-in depth	Distance to focal point	Spot diameter
8 mm	13 mm approx.	$\phi 0.5$ mm
10 mm	15 mm approx.	$\phi 0.8$ mm
14 mm	30 mm approx.	$\phi 3.0$ mm

Note: The sensing ranges are the values when used in combination with red LED type amplifier. Please contact our office for details on sensing distances for other types of amplifier.

FX-301

FIBER OPTIONS

Others

Designation	Model No.	Description	
Protective tube (For thru-beam type fiber)	FTP-500 (0.5 m 1.640 ft)	For M4 thread	FT-B8 FT-FM2 FT-FM2S FT-FM2S4 FT-P80
	FTP-1000 (1 m 3.281 ft)		FT-P60 FT-H13-FM2
	FTP-1500 (1.5 m 4.921 ft)		
	FTP-N500 (0.5 m 1.640 ft)	For M3 thread	FT-T80 FT-NFM2 FT-NFM2S FT-NFM2S4
	FTP-N1000 (1 m 3.281 ft)		FT-P40 FD-T40 FD-P40
	FTP-N1500 (1.5 m 4.921 ft)		
Protective tube (For reflective type fiber)	FDP-500 (0.5 m 1.640 ft)	For M6 thread	FD-B8 FD-FM2 FD-FM2S FD-FM2S4 FD-P80
	FDP-1000 (1 m 3.281 ft)		FD-H13-FM2
	FDP-1500 (1.5 m 4.921 ft)	For M4 thread	FD-T80 FD-N4 FD-NFM2 FD-NFM2S FD-NFM2S4
	FDP-N500 (0.5 m 1.640 ft)		
	FDP-N1000 (1 m 3.281 ft)		
	FDP-N1500 (1.5 m 4.921 ft)		
Fiber bender	FB-1	The fiber bender bends the sleeve part of the fiber head at the proper radius. (Note 1)	
Universal sensor mounting stand (Note 2)	MS-AJ1-F	Horizontal mounting type	Mounting stand assembly for fiber (For M3, M4 or M6 threaded head fiber)
	MS-AJ2-F	Vertical mounting type	
Fiber cutter	FX-CT1	The free-cut type fiber can be easily cut. (Accessory for FT/FD-P80 only)	
	FX-CT2	The free-cut type fiber can be easily cut. (Accessory for the free-cut type fiber. Not attached with the FT-N8/NB8/P80 and FD-N8/N4/P80)	
Attachment for fixed-length fiber	FX-AT2	This is the attachment for the fixed length fiber. (Accessory)	
Attachment for $\phi 2.2$ mm $\phi 0.087$ in fiber	FX-AT3	This is the attachment for the $\phi 2.2$ mm $\phi 0.087$ in fiber. (Accessory. Does not attach with the FT-N8/NB8/P80 or the FD-N8/P80.) (Note 3)	
Attachment for $\phi 1$ mm $\phi 0.039$ in fiber	FX-AT4	This is the attachment for the $\phi 1$ mm $\phi 0.039$ in fiber (Accessory. Does not attach with the FD-N4.) (Note 3)	
Attachment for $\phi 1.3$ mm $\phi 0.051$ in fiber	FX-AT5	This is the attachment for the $\phi 1.3$ mm $\phi 0.051$ in fiber (Accessory)	
Attachment for $\phi 1$ mm $\phi 0.039$ in / $\phi 1.3$ mm $\phi 0.051$ in mixed fiber	FX-AT6	This is the attachment for the $\phi 1$ mm $\phi 0.039$ in / $\phi 1.3$ mm $\phi 0.051$ in mixed fiber. (Accessory)	

Notes: 1) Do not bend the sleeve part of any side-view type fiber or ultra-small diameter head type fiber.
 2) Refer to p.332~ for details of the universal sensor mounting stand.
 3) The conventional FX-AT10 fiber attachment is attached with the FD-N4.

Fiber attachment

It's possible to simultaneously cut two fibers to the same length

Each fiber (with some exceptions) has a newly developed two-in-one fiber attachment (FX-AT3/AT4/AT5/AT6) which enables two fibers to be cut simultaneously to the same length with the new fiber cutter (FX-CT2). Also, since the fibers can be attached to the amplifier while being fixed in position in the two-in-one fiber attachment, sensitivity changes resulting from variation in the amount of fiber insertion do not occur.

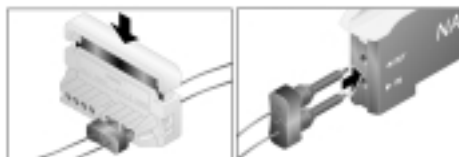

FX-AT2

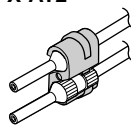

FX-AT3

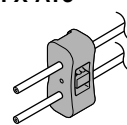

FX-AT4/AT5/AT6

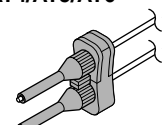

Protective tube

- FTP-□
- FDP-□

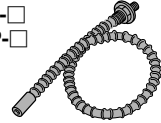

Fiber bender

- FB-1

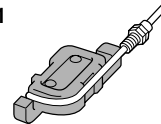

Universal sensor mounting stand

- MS-AJ1-F
- MS-AJ2-F

Using the arm which enables adjustment in the horizontal direction, sensing can also be done from above an assembly line.

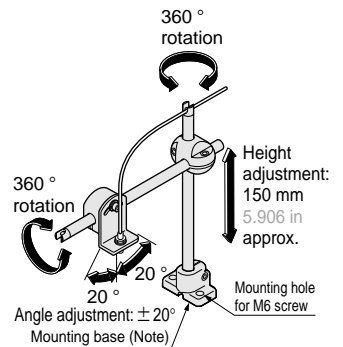

Note: The above figure is MS-AJ1-F. The mounting base of MS-AJ2-F has a different shape.

Fiber cutter

- FX-CT2

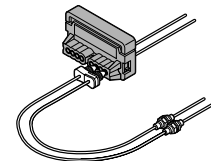

- FX-CT1



SPECIFICATIONS

Amplifiers

Item	Type Model No.	NPN output				PNP output			
		Red LED FX-301	Blue LED FX-301B	Green LED FX-301G	Infrared LED FX-301H	Red LED FX-301P	Blue LED FX-301BP	Green LED FX-301GP	Infrared LED FX-301HP
Supply voltage		12 to 24 V DC \pm 10 % Ripple P-P 10 % or less							
Power consumption		<Red LED / Infrared LED type> Normal operation: 960 mW or less (Current consumption 40 mA or less at 24 V supply voltage) ECO mode: 600 mW or less (Current consumption 25 mA or less at 24 V supply voltage)				<Blue LED / Green LED type> Normal operation: 720 mW or less (Current consumption 30 mA or less at 24 V supply voltage) ECO mode: 430 mW or less (Current consumption 18 mA or less at 24 V supply voltage)			
Output		NPN open-collector transistor • Maximum sink current: 100 mA (50 mA, if five, or more, amplifiers are connected in cascade.) • Applied voltage: 30 V DC or less (between output and 0 V) • Residual voltage: 1.5 V or less (at 100 mA (at 50 mA, if five, or more, amplifiers are connected in cascade) sink current.)				PNP open-collector transistor • Maximum source current: 100 mA (50 mA, if five, or more, amplifiers are connected in cascade.) • Applied voltage: 30 V DC or less (between output and + V) • Residual voltage: 1.5 V or less (at 100 mA (at 50 mA, if five, or more, amplifiers are connected in cascade) source current.)			
	Utilization category	DC-12 or DC-13							
	Output operation	Selectable either Light-ON or Dark-ON, with jog switch							
	Short-circuit protection	Incorporated							
Response time		150 μ s or less (FAST), 250 μ s or less [STD / S-D (Red LED type only)], 2 ms or less (LONG) selectable with jog switch							
Sensitivity setting		2-level teaching / Limit teaching / Manual adjustment / Full auto-teaching (excluding red LED type)							
Operation indicator		Orange LED (lights up when the output is ON)							
Stability indicator		Green LED (lights up under stable light received condition or stable dark condition)							
MODE indicator		RUN: Green LED, TEACH · ADJ · L/D ON · TIMER · PRO: Yellow LED							
Digital display		4 digit red LED display							
Fine sensitivity adjustment function		Incorporated							
Timer function		Incorporated with variable ON-delay / OFF-delay / ONE SHOT timer, switchable either effective or ineffective. (timer period: 0.5 to 500 ms approx.)							
Automatic interference prevention function		Incorporated (Up to four sets of fiber heads can be mounted close together) (Note 1)							
Environmental resistance	Pollution degree	3 (Industrial environment)							
	Ambient temperature	- 10 to +55 °C + 14 to +131 °F (If 4 to 7 units are connected in cascade: - 10 to +50 °C + 14 to +122 °F, if 8 to 16 units are connected in cascade: - 10 to +45 °C + 14 to +113 °F) (No dew condensation or icing allowed), Storage: - 20 to +70 °C - 4 to +158 °F							
	Ambient humidity	35 to 85 % RH, Storage: 35 to 85 % RH							
	Ambient illuminance	Sunlight: 10,000 lx at the light-receiving face, Incandescent light: 3,000 lx at the light-receiving face							
	EMC	Red LED type: EN 50081-2, EN 50082-2, EN 60947-5-2 Blue / green / infrared LED type: EN 60947-5-2							
	Voltage withstandability	1,000 V AC for one min. between all supply terminals connected together and enclosure (Note 2)							
	Insulation resistance	20 M Ω , or more, with 250 V DC megger between all supply terminals connected together and enclosure (Note 2)							
	Vibration resistance	10 to 150 Hz frequency, 0.75 mm 0.030 in amplitude in X, Y and Z directions for two hours each							
Shock resistance	98 m/s ² acceleration (10 G approx.) in X, Y and Z directions for five times each								
Emitting element (modulated)		Red LED	Blue LED	Green LED	Infrared LED	Red LED	Blue LED	Green LED	Infrared LED
Material		Enclosure: Heat-resistant ABS, Case cover: Polycarbonate, Switch: Acrylic							
Connecting method		Connector (Note 3)							
Cable extension		Extension up to total 100 m 328.084 ft is possible with 0.3 mm ² , or more, cable.							
Weight		25 g approx.							

- Notes: 1) When the power supply is switched on, the emission timing are automatically set for interference prevention.
 2) The voltage withstandability and the insulation resistance values given in the above table are for the amplifier only.
 3) The cable for amplifier connection is not supplied as an accessory. Make sure to use the optional quick-connection cable given below.
 Main cable (3-core): **CN-73-C1** (cable length 1 m 3.281 ft), **CN-73-C2** (cable length 2 m 6.562 ft), **CN-73-C5** (cable length 5 m 16.404 ft)
 Sub cable (1-core): **CN-71-C1** (cable length 1 m 3.281 ft), **CN-71-C2** (cable length 2 m 6.562 ft), **CN-71-C5** (cable length 5 m 16.404 ft)

FX-301

SPECIFICATIONS

Fibers

Item	Type	Standard	Flexible
Allowable bending radius		R25 mm R0.984 in or more [Sleeve of a head with sleeve: R10 mm R0.394 in or more (Note 1)]	R4 mm R0.157 in or more
Bending durability			1 million times or more (at R10 mm R0.394 in, FT-P40/P2 and FD-P40/P2 : at R4 mm R0.157 in)
Ambient temperature		- 40 to + 70 °C - 40 to + 158 °F (FT-SFM2SV2: - 20 to + 70 °C - 4 to + 158 °F FT-V22, FD-SFM2SV2: - 20 to + 60 °C - 4 to + 140 °F FT-V41, FD-V41, FT-V10: - 40 to + 60 °C - 40 to + 140 °F)	- 40 to + 70 °C - 40 to + 158 °F (FT-Z8□, FT-P60, FT-PS1, FD-P60, FD-P50:) - 40 to + 60 °C - 40 to + 140 °F
Ambient humidity		35 to 85%RH (No dew condensation or icing allowed)	
Material	Fiber core	Acrylic	
	Sheath	Polyethylene (FT-V22 : Polyolefin)	Vinyl chloride (FT-PS1 : Polyethylene, FD-P2 : Vinyl chloride and Polyurethane)
	Fiber head	Brass (Nickel plated) (FT-SFM2L/T80/SFM2/SNFM2/SFM2SV2/V22/V41, FD-T80/T40/S80/SNFM2/SFM2SV2/V41 and Sleeve: Stainless steel (SUS) FT-FM10L: ABS, Lens of FT-FM10L/SFM2L/V10: Acrylic FT-V10: Stainless steel (SUS) and Polycarbonate	Stainless steel (SUS) (FT/FD-P80, FT-P60: Brass (Nickel plated) Case of FT-Z8□ : Polycarbonate Lens of FT-Z8H/Z8E , Front film of FT-Z8 : Polyester
Accessories (Note 2)	All fibers (except for FT-NB8/N8 and FD-N8/N4): 1 fiber attachment set Free-cut type fibers (except for FT-NB8/N8 and FD-N8/N4): FX-CT2 (fiber cutter) 1 pc. Threaded head fibers: Nuts 2 pcs. (thru-beam type: 4 pcs.) and toothed lock washer 1 pc. (thru-beam type: 2 pcs.)	All fibers: 1 fiber attachment set. (except for FT-P80 and FD-P80) Free-cut type fibers: FX-CT2 (fiber cutter) 1 pc. (FT/FD-P80: FX-CT1 1 pc.) Threaded head fibers: Nuts 2 pcs. (thru-beam type: 4 pcs.) and toothed lock washer 1 pc. (thru-beam type: 2 pcs.), FT-Z8□ : 1 set of mounting screw	

Notes: 1) Sleeve part of side-view fiber cannot be bent.

2) The five types of attached fiber attachments (**FX-AT2/AT3/AT4/AT5/AT6**) described in this catalog are for use only with the **FX-301/302/303/311** series. Refer to p.76 for details 'FIBER OPTIONS'. Fiber attachment accessories are also supplied along with conventional amplifiers. Please contact our office for more details on these accessories.

Item	Type	Sharp bending
Allowable bending radius		R1 mm R0.039 in or more (FD-WG4/WG4 : R2 mm R0.079 in or more, Sleeve of FD-W44 : R10 mm R0.394 in or more)
Ambient temperature		- 40 to + 60 °C - 40 to + 140 °F (FT-WA30/WA8/WKV8 : - 40 to + 55 °C - 40 to + 131 °F)
Ambient humidity		35 to 85 %RH (No dew condensation or icing allowed)
Material	Fiber core	Acrylic
	Sheath	Polyethylene
	Fiber head	Stainless steel (SUS) (including sleeve) (FT-W8/W4, FD-W8/W44/WG4: Brass (Nickel plated) Case of FT-WA30/WA8/WZ8□ , Lens of FT-WS8L and Resin part of FT-WKV8 : Polycarbonate, Lens of FT-WA30 : Norbornene resin Lens of FT-WA8 : Polyolefin, Lens of FT-WZ8H/WZ8E , Reflector of FT-WZ8E and Prism of FT-WKV8 : Acrylic, Reflector of FT-WZ8 : Polycarbonate, FD-WL41 : Heat-resistant ABS, Front film of FD-WL41 : Polyester, FD-WL42 : Aluminum (Black ALMITE), Lens of FD-WKZ1 : Optical lens
Accessories (Note)	All fibers: 1 fiber attachment set and FX-CT2 (fiber cutter) 1 pc. Threaded fibers: Nuts 2 pcs. (thru-beam type: 4 pcs.) and toothed lock washer 1 pc. (thru-beam type: 2 pcs.) FT-WA30 : 0.5 × 32 mm 0.020 × 1.260 in seal type slit mask 2 pcs. FT-WA8 : 0.5 × 12 mm 0.020 × 0.472 in seal type slit mask 2 pcs. and 1 × 12 mm 0.039 × 0.472 in seal type slit mask 2 pcs. FT-WZ8□ : 1 set of mounting screw FD-WKZ1 : mounting bracket 1 pc.	

Note: The five types of attached fiber attachments (**FX-AT2/AT3/AT4/AT5/AT6**) described in this catalog are for use only with the **FX-301/302/303/311** series. Refer to p.76 for details 'FIBER OPTIONS'. Fiber attachment accessories are also supplied along with conventional amplifiers. Please contact our office for more details on these accessories.

Item	Type	Special use			
		Wide beam	Array	Narrow beam	High precision
Allowable bending radius		FT-A30/A8 : R10 mm R0.394 in or more FD-A15 : R25 mm R0.984 in or more	R25 mm R0.984 in or more	R25 mm R0.984 in or more (FT-KV1 : R10 mm R0.394 in or more)	FD-EG2/EG3 : R10 mm R0.394 in or more FD-G4/G6/EG1 : R25 mm R0.984 in or more
Ambient temperature		FT-A30, FD-A15 : - 40 to + 60 °C - 40 to + 140 °F FT-A8 : - 40 to + 70 °C - 40 to + 158 °F	- 40 to + 70 °C - 40 to + 158 °F	- 40 to + 60 °C - 40 to + 140 °F	- 20 to + 60 °C - 4 to + 140 °F (FD-G4: - 40 to + 70 °C - 40 to + 158 °F) (FD-G6: - 40 to + 60 °C - 40 to + 140 °F)
Ambient humidity		35 to 85 %RH (No dew condensation or icing allowed)			
Material	Fiber core	Acrylic			
	Sheath	Polyethylene			Polyolefin (FD-G4/G6 : Polyethylene)
	Fiber head	Polycarbonate (Lens of FT-A30, FD-A15 : Norbornene resin) Lens of FT-A8 : Polyolefin	Brass (Nickel plated)	Stainless steel (SUS), Polycarbonate (Lens: Norbornene resin Lens of FT-KV1 : Polycarbonate, Prism of FT-KV8 : Acrylic)	Brass (Nickel plated) [FD-G6: Stainless steel (SUS)]
Accessories (Note)	All fibers: 1 fiber attachment set and FX-CT2 (fiber cutter) 1 pc. FT-A30 : 0.5 × 32 mm 0.020 × 1.260 in seal type slit mask 2 pcs. FT-A8 : 0.5 × 12 mm 0.020 × 0.472 in seal type slit mask 2 pcs. and 1 × 12 mm 0.039 × 0.472 in seal type slit mask 2 pcs.	All fibers: 1 fiber attachment set Free-cut type fibers: FX-CT2 (fiber cutter) 1 pc. Threaded head fibers: Nuts 2 pcs. and toothed lock washer 1 pc.			

Note: The five types of attached fiber attachments (**FX-AT2/AT3/AT4/AT5/AT6**) described in this catalog are for use only with the **FX-301/302/303/311** series. Refer to p.76 for details 'FIBER OPTIONS'. Fiber attachment accessories are also supplied along with conventional amplifiers. Please contact our office for more details on these accessories.

SPECIFICATIONS

Fibers

Item	Type	Special use		
		Ultra-small diameter	Fixed-focus reflective	Tough flexible
Allowable bending radius		FT-E12/E22: R5 mm R0.197 in or more (Note 1) FD-E12: R10 mm R0.394 in or more (Note 1) FD-E22/EN500S1/ENM1S1: R25 mm R0.984 in or more (Note 1)	R10 mm R0.394 in or more (FD-L43: R4 mm R0.157 in or more)	R10 mm R0.394 in or more
Ambient temperature		FT-E12/E22, FD-E22: -40 to +70 °C -40 to +158 °F FD-E12: -40 to +60 °C -40 to +140 °F FD-EN500S1/ENM1S1: -20 to +60 °C -4 to +140 °F	FD-L43: 0 to +70 °C +32 to +158 °F FD-L41/L42: -40 to +60 °C -40 to +140 °F FD-L4: -40 to +70 °C -40 to +158 °F	-40 to +60 °C -40 to +140 °F (FD-P81X: -40 to +70 °C -40 to +158 °F)
Ambient humidity		35 to 85 %RH (No dew condensation or icing allowed)		
Material	Fiber core	Acrylic		
	Sheath	Polyolefin	Polyethylene (FD-L42: Vinyl chloride)	Polyethylene [FT-P81X: Vinyl chloride, Protective tube: Stainless steel (SUS)]
	Fiber head	Brass (Nickel plated) [Sleeve: Stainless steel (SUS)]	FD-L43/L41: Heat-resistant ABS FD-L4: ABS FD-L42: Aluminum (Black ALMITE) (Lens of FD-L43/L4: Acrylic Front film of FD-L41: Polyester)	FT-P81X, FD-P81X: Brass (Nickel plated) FD-G6X: Stainless steel (SUS)
Accessories (Note 2)		All fibers: 1 fiber attachment set and FX-CT2 (fiber cutter) 1 pc. FD-L4: M2.6 (length 12 mm 0.472 in) screws with washers 2 pcs. and nuts 2 pcs.	All fibers: 1 fiber attachment set, nuts 2 pcs. (thru-beam type: 4 pcs.) and toothed lock washer 1 pc. (thru-beam type: 2 pcs.) FD-G6X: FX-CT2 (fiber cutter) 1 pc.	

Notes: 1) Sleeve part cannot be bent.

2) The five types of attached fiber attachments (FX-AT2/AT3/AT4/AT5/AT6) described in this catalog are for use only with the FX-301/302/303/311 series. Refer to p.76 for details 'FIBER OPTIONS'. Fiber attachment accessories are also supplied along with conventional amplifiers. Please contact our office for more details on these accessories.

Item	Type	Special use	
		Liquid level sensing	
Model No.		FD-F8Y	FD-F4□/F9□
Allowable bending radius		Protective tube: R40 mm R1.575 in or more Fiber: R15 mm R0.591 in or more	R10 mm R0.394 in or more
Ambient temperature		-40 to +125 °C -40 to +257 °F (Note 1)	-40 to +100 °C -40 to +212 °F (Note 1)
Ambient humidity		35 to 85 %RH (No dew condensation or icing allowed)	
Material	Fiber core	Polycarbonate	
	Sheath	Polypropylene (Protective tube: Fluorine resin)	Polyethylene
	Fiber head		Polyetherimide (Lens: Polycarbonate)
Accessories (Note 2)		1 fiber attachment set FX-CT2 (fiber cutter) 1 pc.	1 fiber attachment set, FX-CT2 (fiber cutter) 1pc. Tying bands 4 pcs., anti-slip tubes 2 pcs.

Notes: 1) With the liquid sensing fiber, make sure that the temperature of the liquid is also within the ambient temperature range.

2) The five types of attached fiber attachments (FX-AT2/AT3/AT4/AT5/AT6) described in this catalog are for use only with the FX-301/302/303/311 series. Refer to p.76 for details 'FIBER OPTIONS'. Fiber attachment accessories are also supplied along with conventional amplifiers. Please contact our office for more details on these accessories.

Item	Type	Environment resistant					Chemical-resistant	Vacuum
		350 °C 662 °F type	300 °C 572 °F type	200 °C 392 °F type	180 °C 356 °F type	130 °C 266 °F type		
Allowable bending radius		R25 mm R0.984 in or more (FT-H20W-□): R10 mm R0.394 in or more, Sleeve of a head with sleeve: R10 mm R0.394 in or more)					R30 mm R1.181 in or more (FT-Z802Y: R25 mm R0.984 in or more)	R200 mm R7.874 in or more (FT-60V: R30 mm R1.181 in or more)
Ambient temperature		-60 to +350 °C -76 to +662 °F (Note 1, 2)	-60 to +300 °C -76 to +572 °F (Note 1, 2, 3)	-60 to +200 °C -76 to +392 °F (Note 2)	-60 to +180 °C -76 to +356 °F (Note 2, 4)	-60 to +130 °C -76 to +266 °F	-40 to +115 °C -40 to +239 °F (FT-Z802Y: 0 to +60 °C +14 to +140 °F)	-40 to +120 °C -40 to +248 °F
Ambient humidity		35 to 85 %RH (No dew condensation or icing allowed)						
Material	Fiber core	Multi-component glass (Note 3)		Silicone	Acrylic		Quartz glass (Note 3)	
	Sheath	Stainless steel (SUS)		Silicone (Inside stainless steel (SUS) spiral tube FD-H20-21: Stainless steel (sus) FT-H20W-□: Fluorine resin)	Fluorine resin		Fluorine resin	
	Fiber head			Brass (Nickel plated) FD-H20-21: Stainless steel (sus)	Stainless steel (SUS)	Brass (Nickel plated)	Protective tube: Fluorine resin Sheath: Polypropylene (Sheath of FT-Z802Y: Fluorine resin)	Aluminum
Accessories (Note 5)		FT-H20W-□, FD-H18-L31 and FT-H13-FM2: 1 fiber attachment set Free-cut type fibers: FX-CT2 (fiber cutter) 1 pc. Threaded head fibers: Nuts 2 pcs. (thru-beam type: 4 pcs.) and toothed lock washer 1 pc. (thru-beam type: 2 pcs.)					1 fiber attachment set FX-CT2 (fiber cutter) 1 pc.	Nuts 2 pcs. (thru-beam type: 4 pcs.) and toothed lock washer 1 pc. (thru-beam type: 2 pcs.)

Notes: 1) If the fiber is used below -30 °C -22 °F, its maximum resistable temperature drops to +200 °C +392 °F. If the side-view lens FX-SV1 is put on the fiber head, the allowable maximum temperature drops to +300 °C +572 °F. (The ambient temperature range of FX-SV1 is from -60 to +300 °C -76 to +572 °F.)

2) The ambient temperature of heat-resistant 350 °C 662 °F type, 300 °C 572 °F type, 200 °C 392 °F type, and 180 °C 356 °F type fibers are the value in dry condition. In humid environment, the ambient temperature differs. (For a high humidity of 85 %RH, the ambient temperature is 0 to +40 °C +14 to 104 °F.)

3) If the fiber material is quartz glass or multi-component glass, keep it away from vibration or impact.

4) The normal temperature for continuous usage or storage should be -60 to +150 °C -76 to +302 °F.

5) The five types of attached fiber attachments (FX-AT2/AT3/AT4/AT5/AT6) described in this catalog are for use only with the FX-301/302/303/311 series. Refer to p.76 for details 'FIBER OPTIONS'. Fiber attachment accessories are also supplied along with conventional amplifiers. Please contact our office for more details on these accessories.

FX-301

I/O CIRCUIT AND WIRING DIAGRAMS

NPN output type

I/O circuit diagram

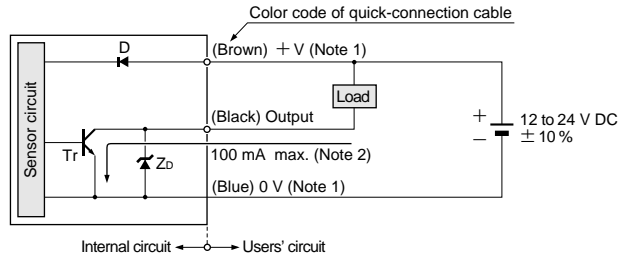

Notes: 1) The quick-connection sub cable does not have +V (brown) and 0 V (blue).
2) 50 mA max., if five amplifiers, or more, are connected together.

Symbols ... D : Reverse supply polarity protection diode
Zd: Surge absorption zener diode
Tr : NPN output transistor

Wiring diagram

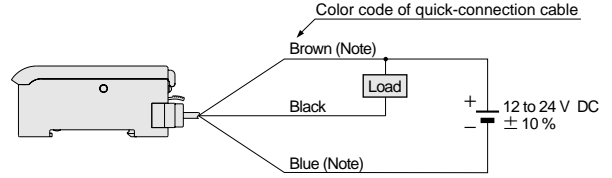

Note: The quick-connection sub cable does not have brown lead wire and blue lead wire.

Terminal arrangement diagram

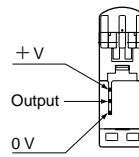

PNP output type

I/O circuit diagram

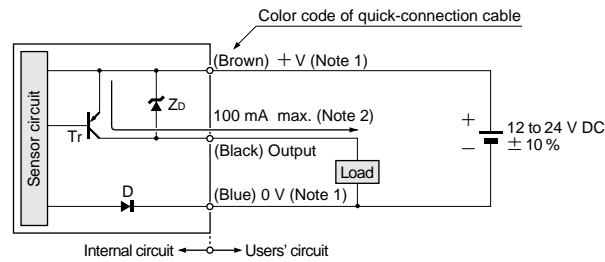

Notes: 1) The quick-connection sub cable does not have +V (brown) and 0 V (blue).
2) 50 mA max., if five amplifiers, or more, are connected together.

Symbols ... D : Reverse supply polarity protection diode
Zd: Surge absorption zener diode
Tr : PNP output transistor

Wiring diagram

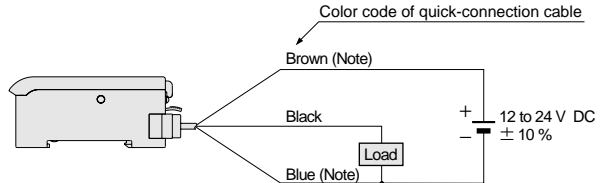

Note: The quick-connection sub cable does not have brown lead wire and blue lead wire.

Terminal arrangement diagram

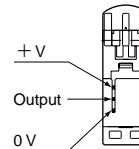

SENSING CHARACTERISTICS (TYPICAL)

The following sensing characteristics pertain to the red LED type. Please contact our office for the sensing characteristics pertaining corresponding to types other than the red LED or to types not mentioned here.

Parallel deviation

FT-FM10L

Thru-beam type

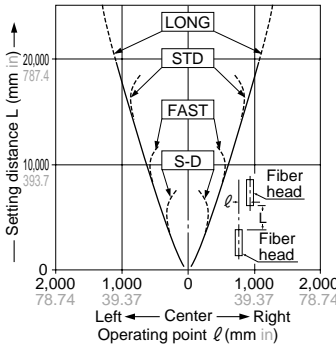
FT-SFM2L

Thru-beam type

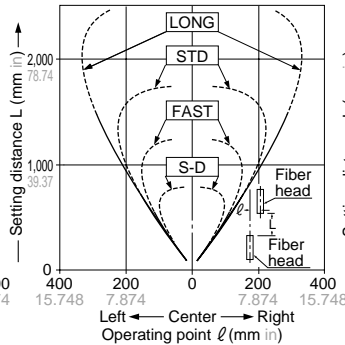
FT-B8

Thru-beam type

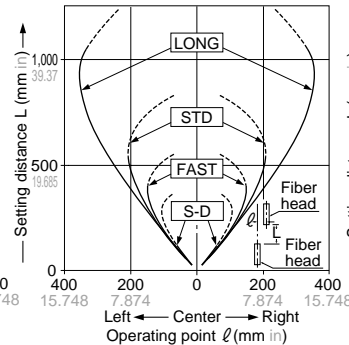
FT-NB8

Thru-beam type

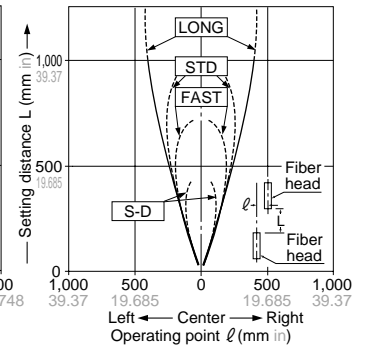
FT-FM2 FT-FM2S FT-FM2S4 FT-T80 FT-SFM2

Thru-beam type

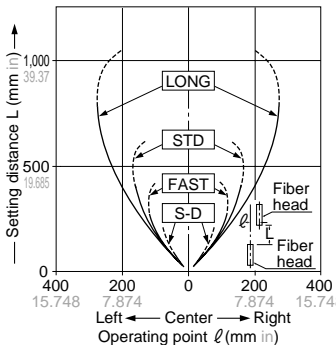
FT-N8

Thru-beam type

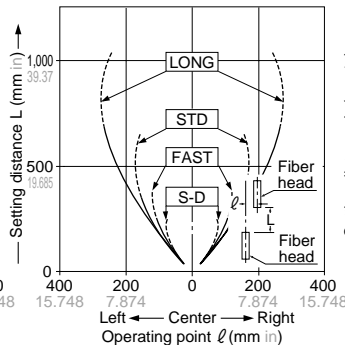
FT-NFM2 FT-NFM2S FT-NFM2S4 FT-SNFM2

Thru-beam type

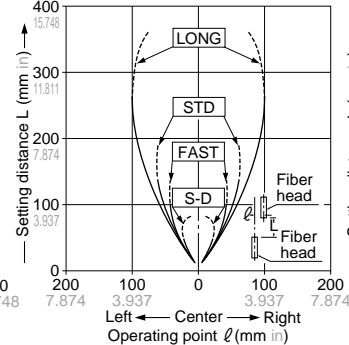
FT-R80

Thru-beam type

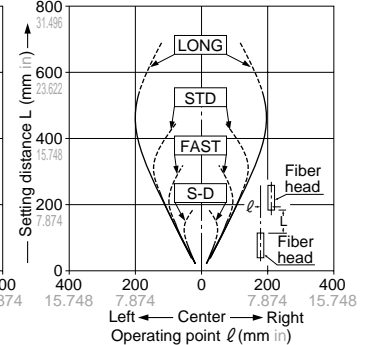
FT-V10

Thru-beam type

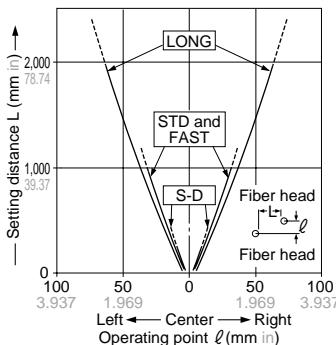
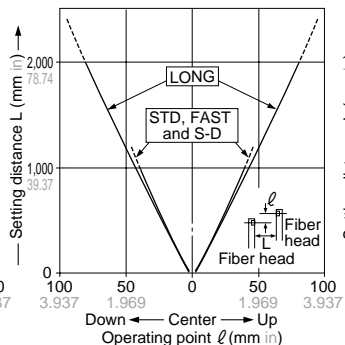
Horizontal direction

Vertical direction

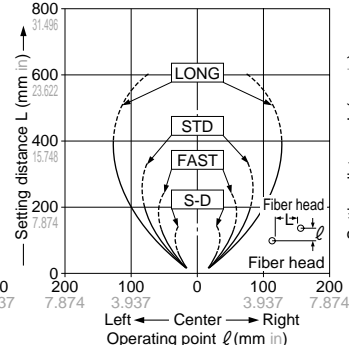
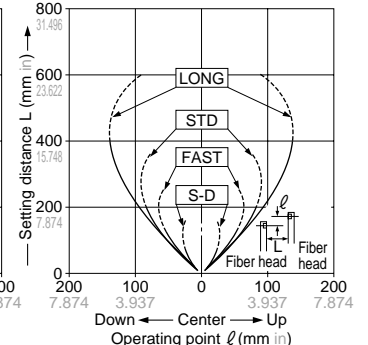
FT-SFM2SV2

Thru-beam type

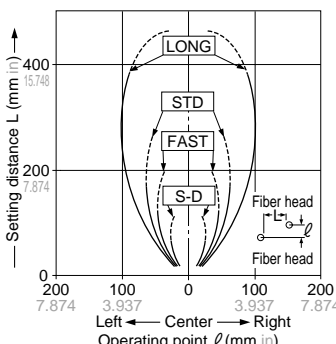
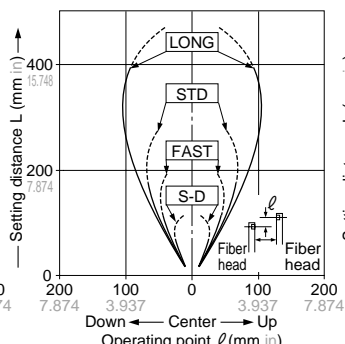
Horizontal direction

Vertical direction

FT-V22

Thru-beam type

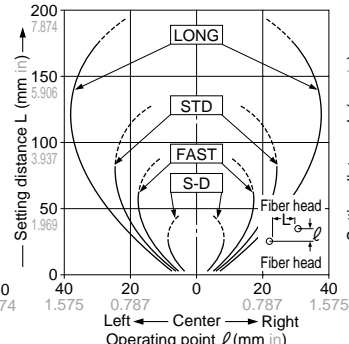
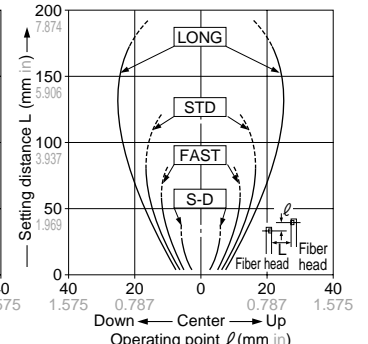
Horizontal direction

Vertical direction

FT-V41

Thru-beam type

Horizontal direction

Vertical direction

 FIBER SENSORS
 Selection
 FX-301
 Digital Setting
 FX-302
 Bank Selection Unit
 FX-303
 FX-CH
 Manually Set
 FX-311
 Analog Output
 FX-11A
 Color Detection
 FZ-10

FX-301

SENSING CHARACTERISTICS (TYPICAL)

The following sensing characteristics pertain to the red LED type. Please contact our office for the sensing characteristics pertaining corresponding to types other than the red LED or to types not mentioned here.

Parallel deviation

**FT-WA30
FT-A30**

Thru-beam type

Horizontal direction

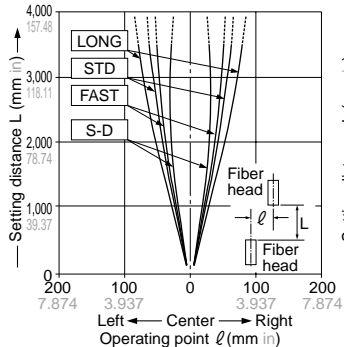

Vertical direction

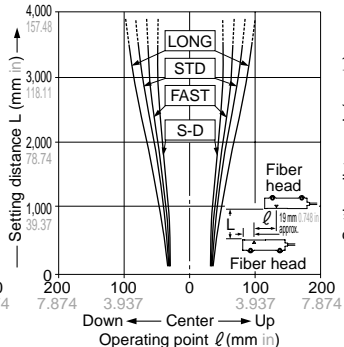

**FT-WA8
FT-A8**

Thru-beam type

Horizontal direction

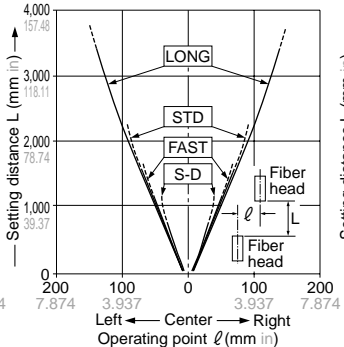

Vertical direction

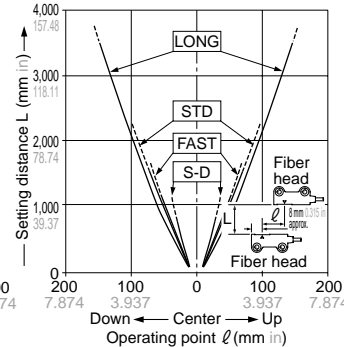

FT-WZ8H

Thru-beam type

Horizontal direction

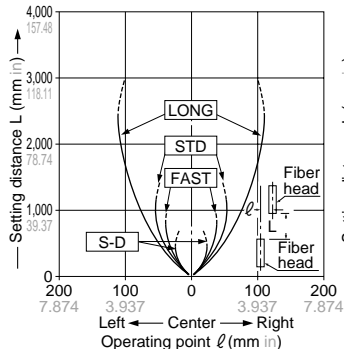

Vertical direction

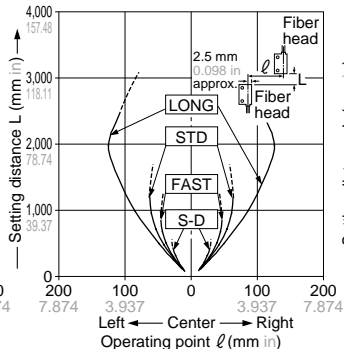

FZ-WZ8E

Thru-beam type

Horizontal direction

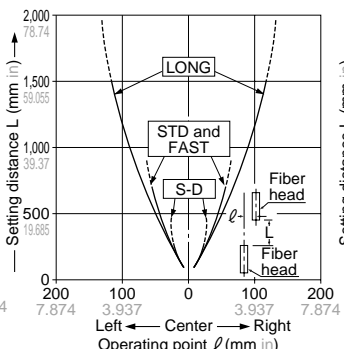

Vertical direction

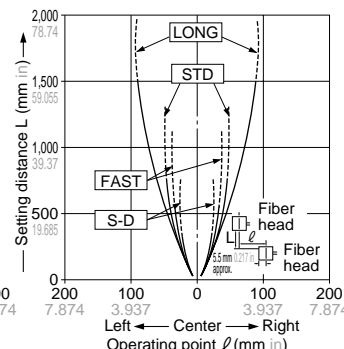

FT-WZ8

Thru-beam type

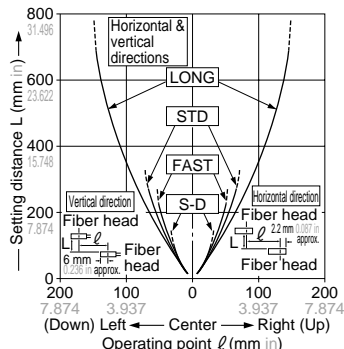

FT-WKW8

Thru-beam type

Horizontal direction

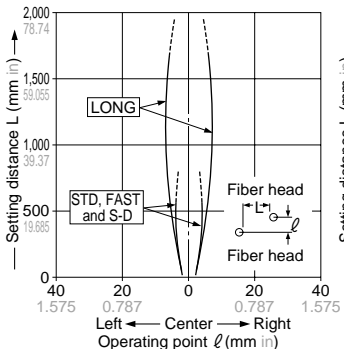

Vertical direction

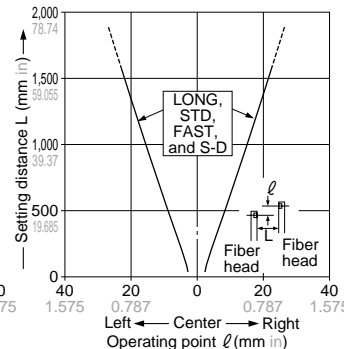

FT-WS8L

Thru-beam type

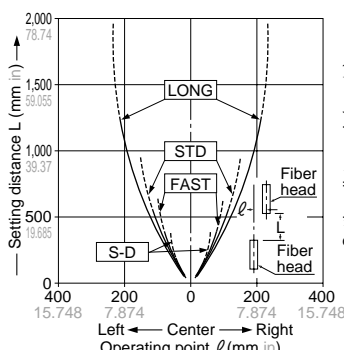

**FT-W8
FT-WS8**

Thru-beam type

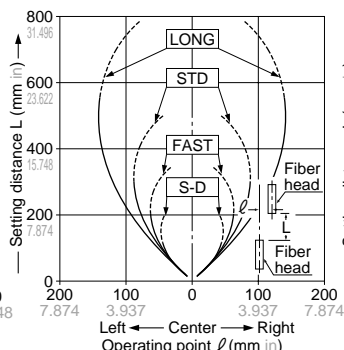

FT-WS3

Thru-beam type

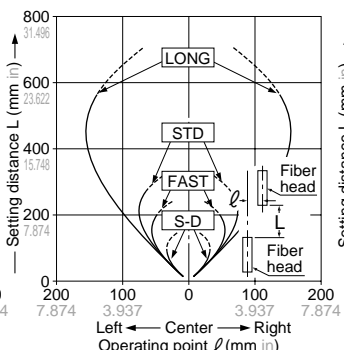

**FT-W4
FT-WS4**

Thru-beam type

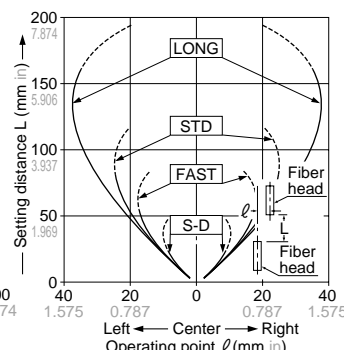

SENSING CHARACTERISTICS (TYPICAL)

The following sensing characteristics pertain to the red LED type. Please contact our office for the sensing characteristics pertaining corresponding to types other than the red LED or to types not mentioned here.

Parallel deviation

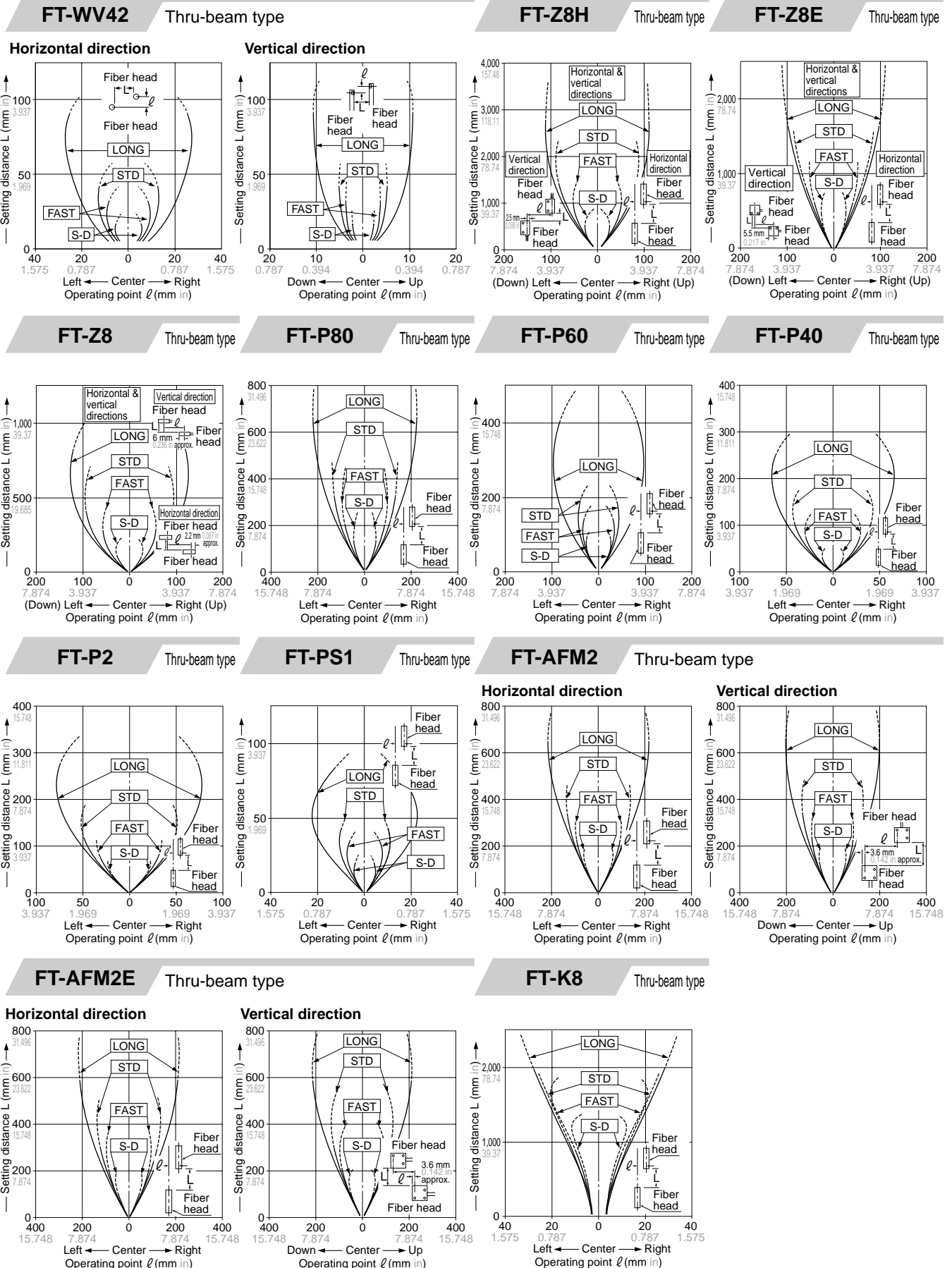

FIBER SENSORS
 Fiber Selection
FX-301
 Digital Setting
 FX-302
 FX-303
 Bank Selection Unit
 FX-CH
 Manually Set
 FX-311
 Analog Output
 FX-11A
 Color Detection
 FX-10

FX-301

SENSING CHARACTERISTICS (TYPICAL) The following sensing characteristics pertain to the red LED type. Please contact our office for the sensing characteristics pertaining corresponding to types other than the red LED or to types not mentioned here.

Parallel deviation

FT-KV1 Thru-beam type

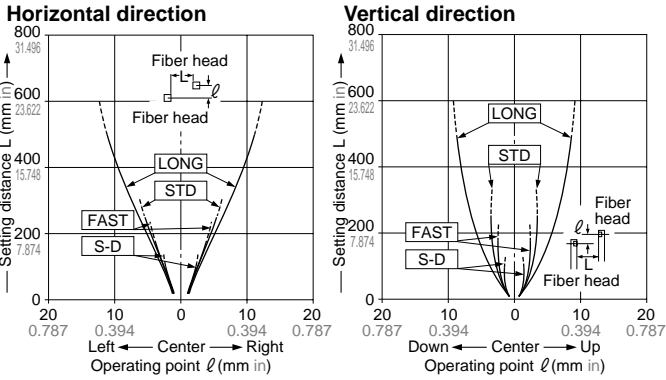

FT-KV8 Thru-beam type

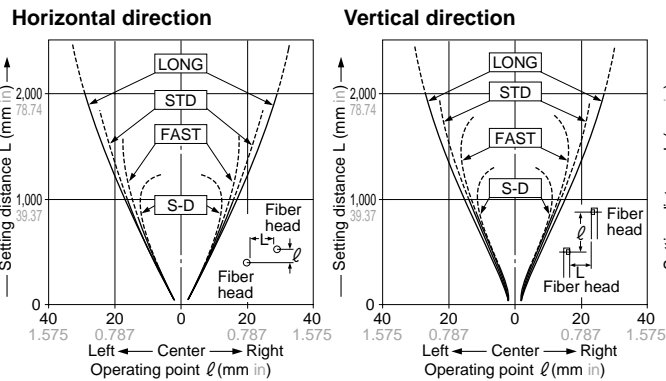

FT-E12 Thru-beam type

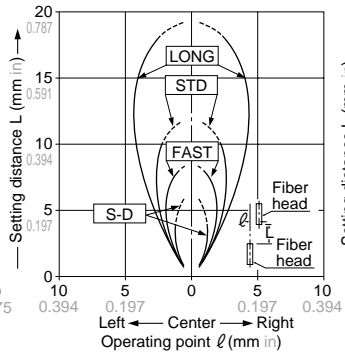

FT-E22 Thru-beam type

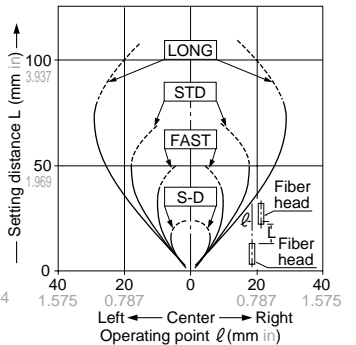

FT-P81X Thru-beam type

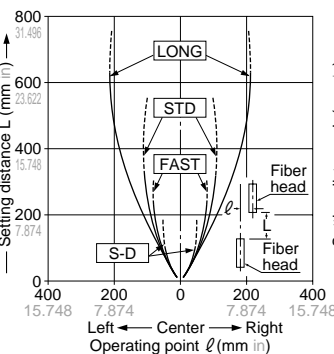

FT-H35-M2 Thru-beam type
FT-H35-M2S6 Thru-beam type

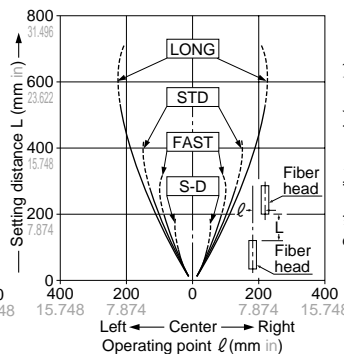

FT-H20W-M1 Thru-beam type
FT-H20W-M2 Thru-beam type

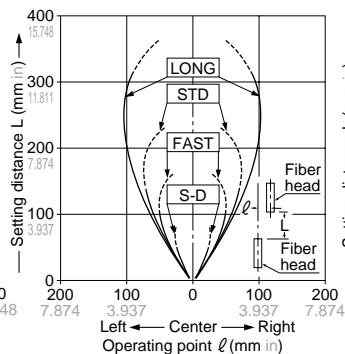

FT-H20-M1 Thru-beam type

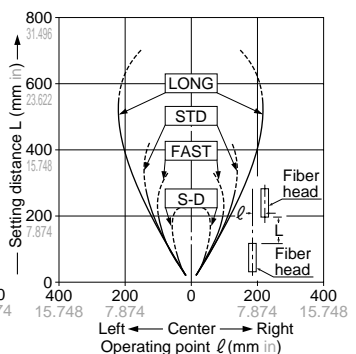

FT-H13-FM2 Thru-beam type

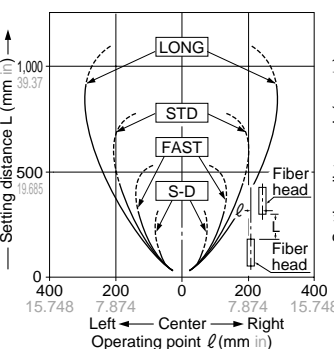

FT-L8Y Thru-beam type

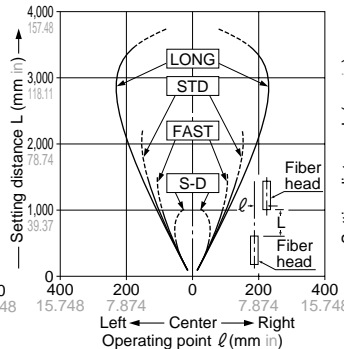

FT-V8Y Thru-beam type

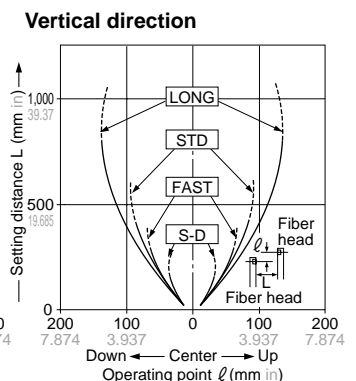
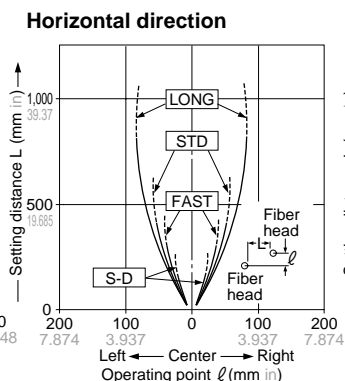

SENSING CHARACTERISTICS (TYPICAL) The following sensing characteristics pertain to the red LED type. Please contact our office for the sensing characteristics pertaining corresponding to types other than the red LED or to types not mentioned here.

Parallel deviation

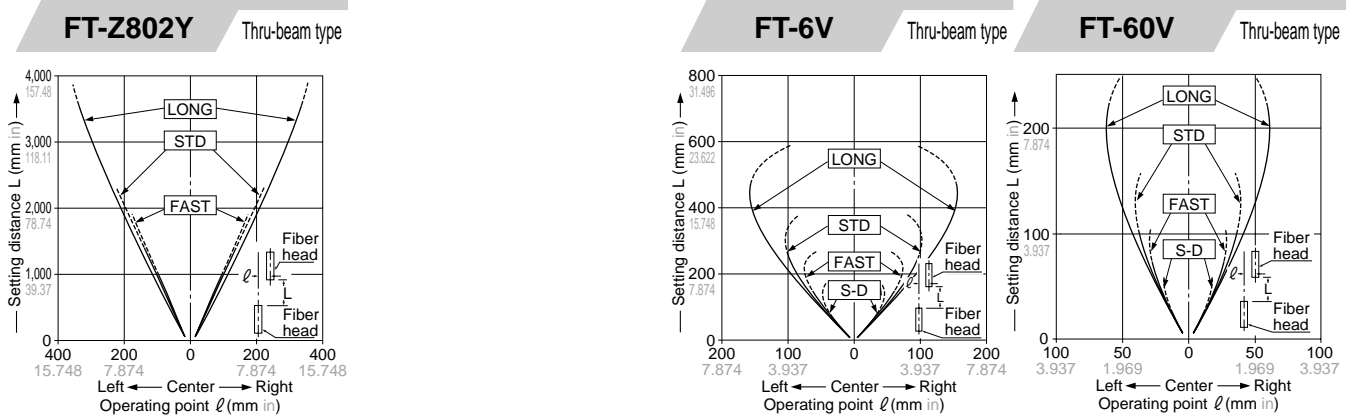

Parallel deviation with FX-LE1 (expansion lens) applied on both sides

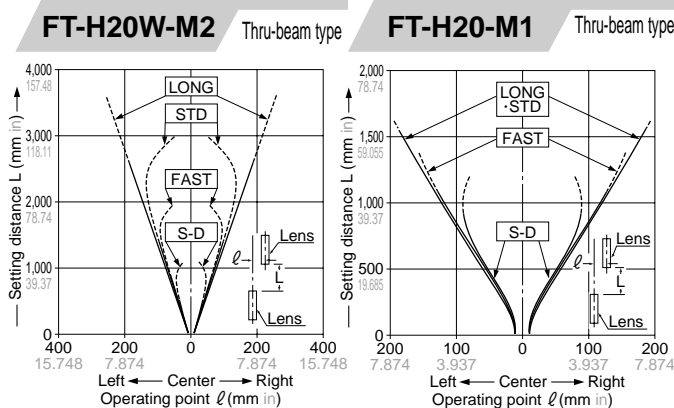
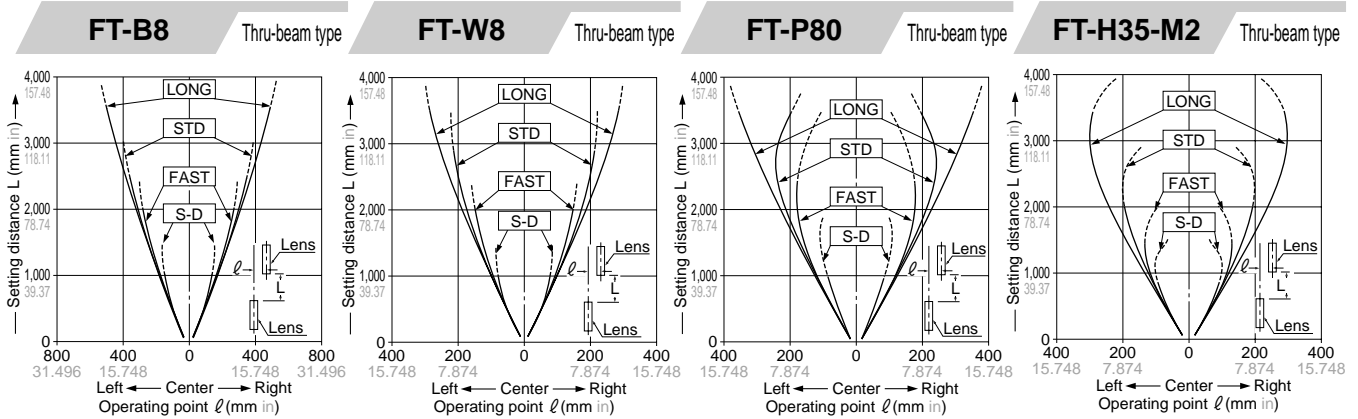

Parallel deviation with FX-LE2 (super-expansion lens) applied on both sides

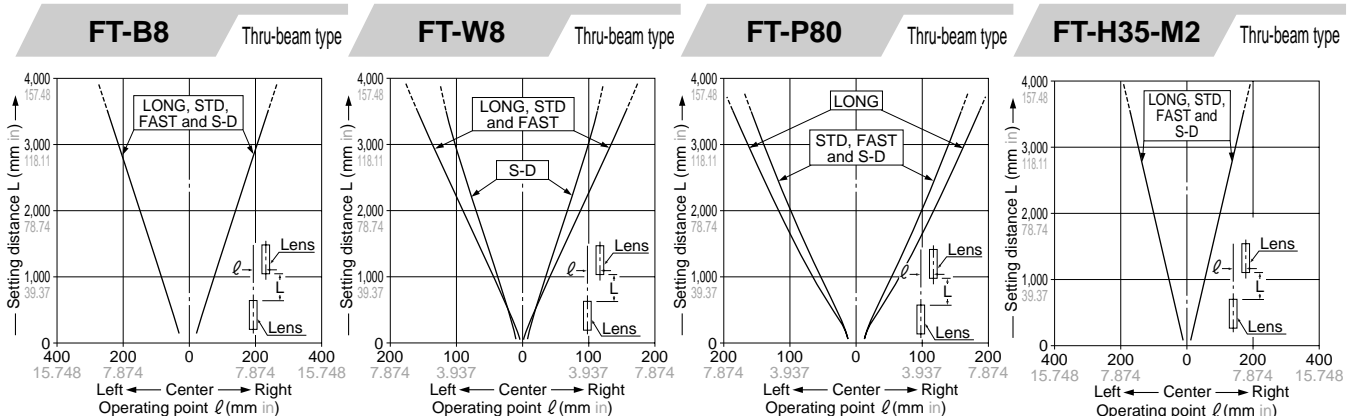

FIBER SENSORS
 Fiber Selection
FX-301
 Digital Setting
 FX-302
 Bank Selection Unit
 FX-CH
 Manually Set
 FX-311
 Analog Output
 FX-11A
 Color Detection
 FZ-10

FX-301

SENSING CHARACTERISTICS (TYPICAL) The following sensing characteristics pertain to the red LED type. Please contact our office for the sensing characteristics pertaining corresponding to types other than the red LED or to types not mentioned here.

Parallel deviation with FX-LE2 (super-expansion lens) applied on both sides

FT-H20W-M2 Thru-beam type

FT-H20-M1 Thru-beam type

FT-H13-FM2 Thru-beam type

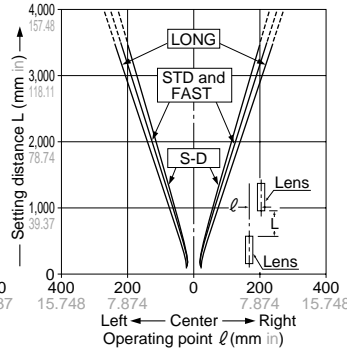
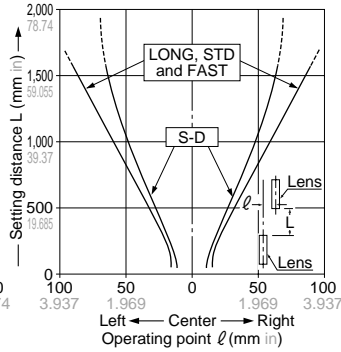
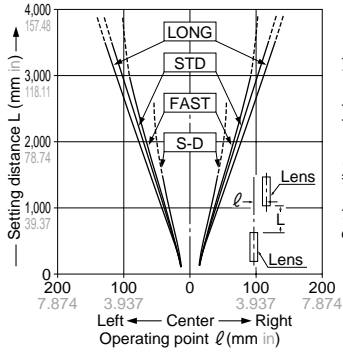

Parallel deviation with FX-SV1 (side-view lens) applied on both sides

FT-B8 Thru-beam type

FT-W8 Thru-beam type

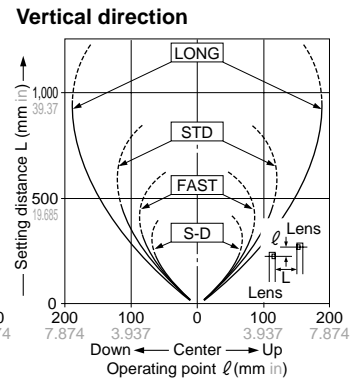
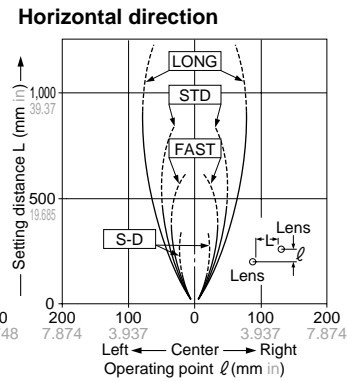
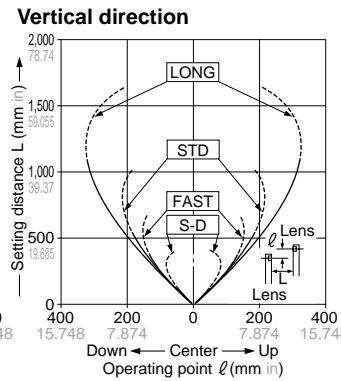
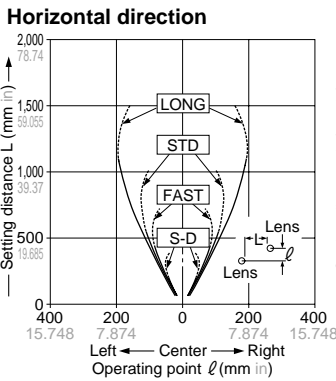

FT-P80 Thru-beam type

FT-H35-M2 Thru-beam type

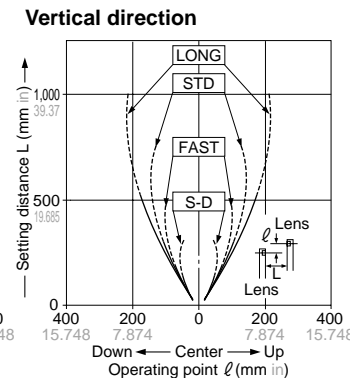
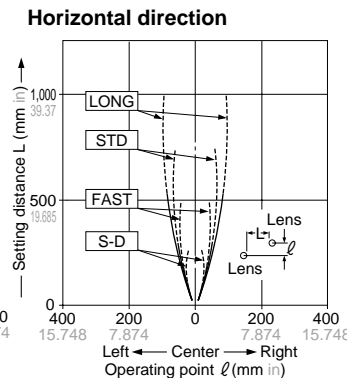
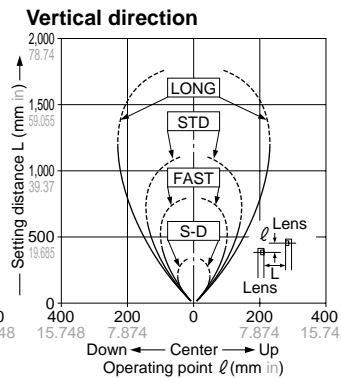
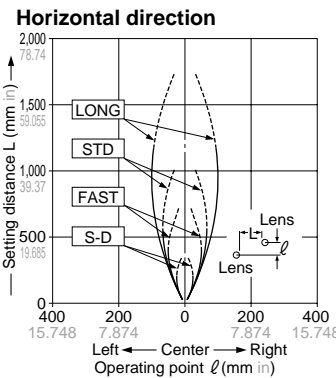

FT-H20W-M2 Thru-beam type

FT-H20-M1 Thru-beam type

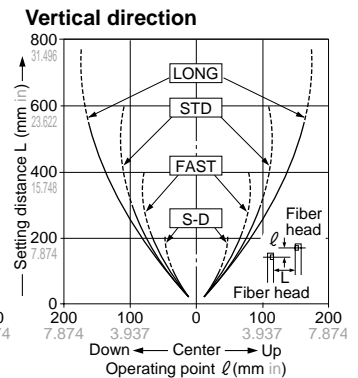
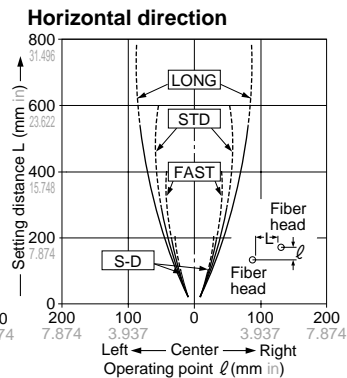
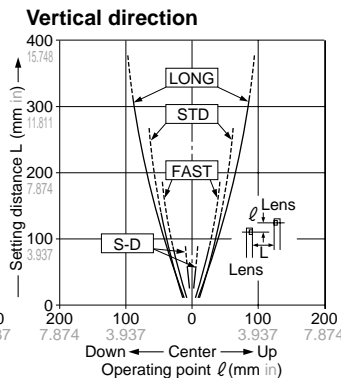
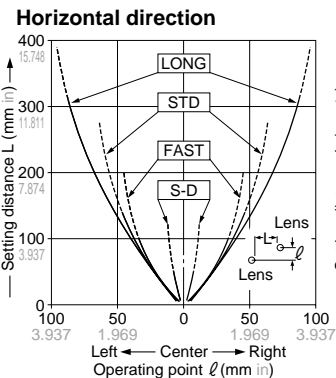

Fiber Selection

FX-301

FX-302 Digital Setting

FX-303

FX-CH Bank Selection Unit

FX-311 Manually Set

FX-11A Analog Output

FZ-10 Color Detection

SENSING CHARACTERISTICS (TYPICAL)

The following sensing characteristics pertain to the red LED type. Please contact our office for the sensing characteristics pertaining corresponding to types other than the red LED or to types not mentioned here.

Sensing fields

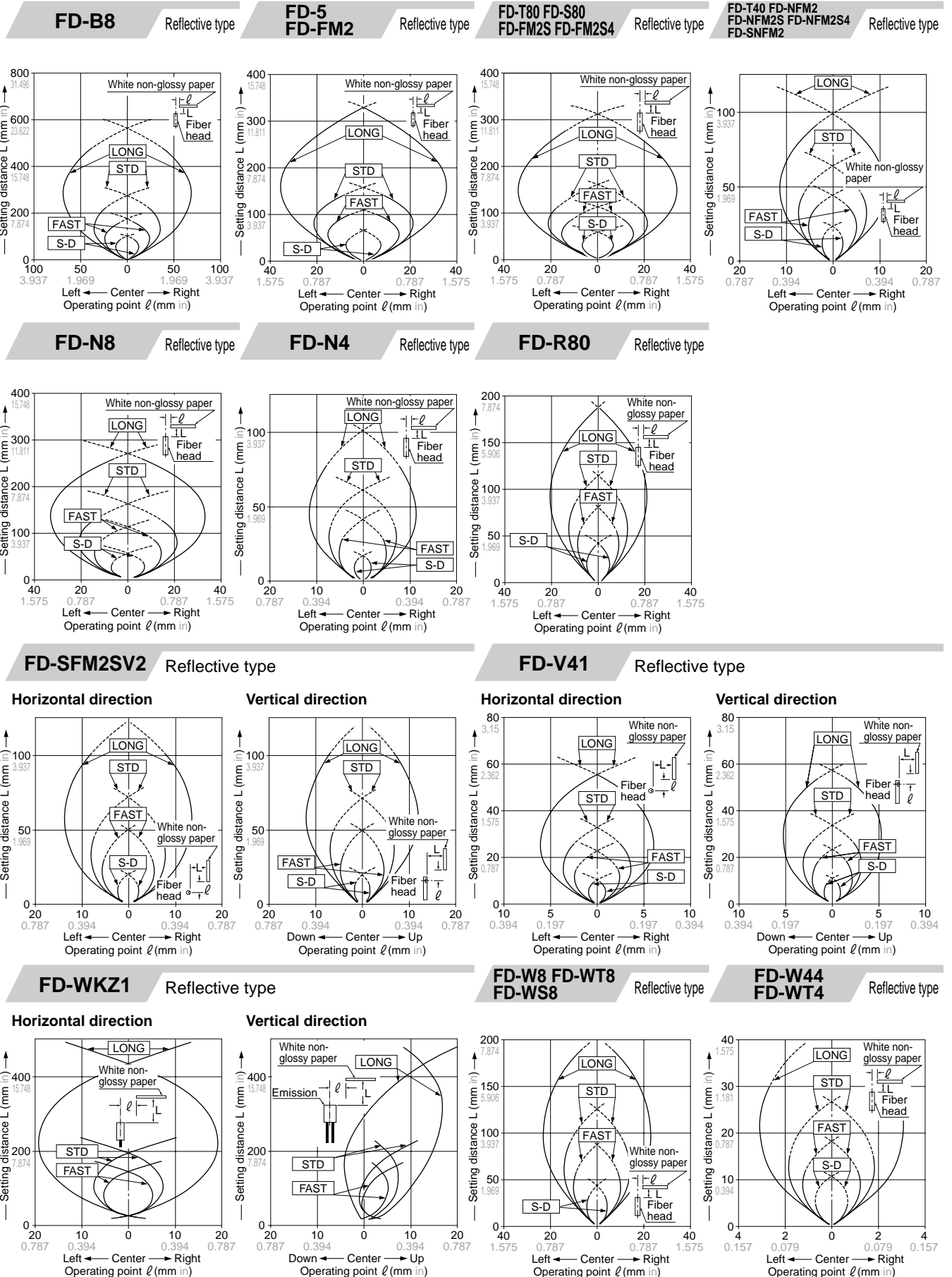

FIBER SENSORS
 Selection
FX-301
 Digital Setting
 Selection
FX-302
 Bank Selection Unit
 Selection
FX-303
 Manually Set
 Selection
FX-311
 Analog Output
 Selection
FX-11A
 Color Detection
 Selection
FZ-10

FX-301

SENSING CHARACTERISTICS (TYPICAL) The following sensing characteristics pertain to the red LED type. Please contact our office for the sensing characteristics pertaining corresponding to types other than the red LED or to types not mentioned here.

Sensing fields

**FD-WG4
FD-WSG4** Reflective type

FD-WV42 Reflective type

FD-P80 Reflective type

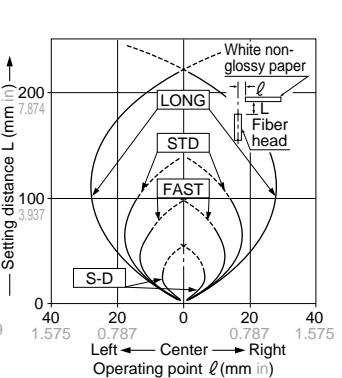
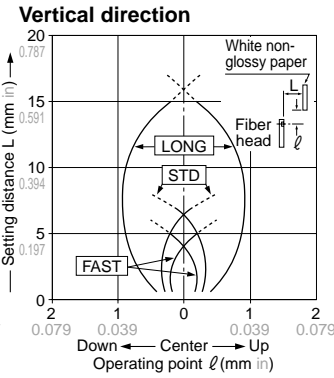
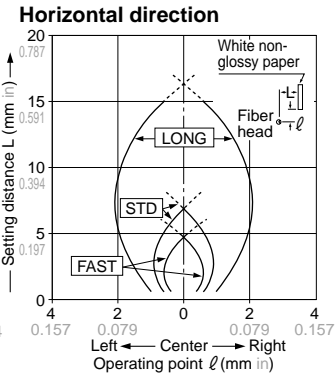
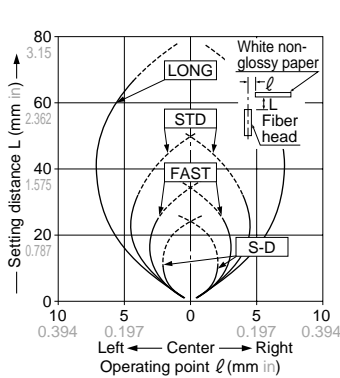

FD-P60 Reflective type

FD-P50 Reflective type

FD-P40 Reflective type

FD-P2 Reflective type

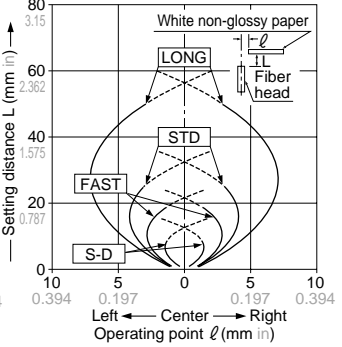
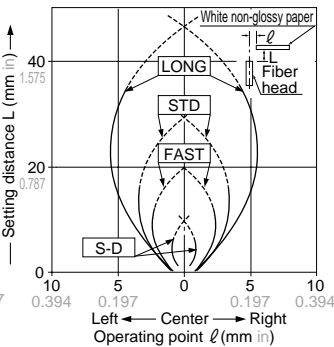
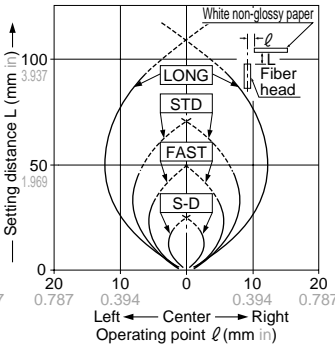
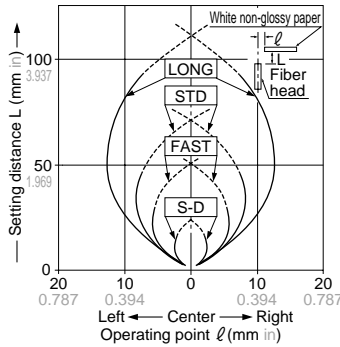

FD-A15 Reflective type

**FD-AFM2
FD-AFM2E** Reflective type

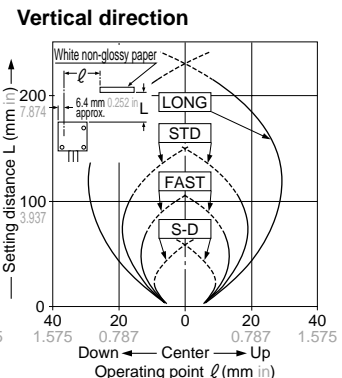
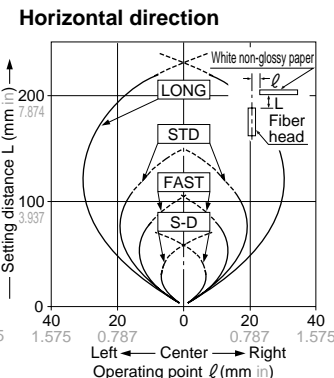
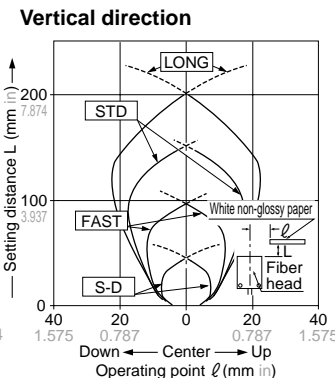
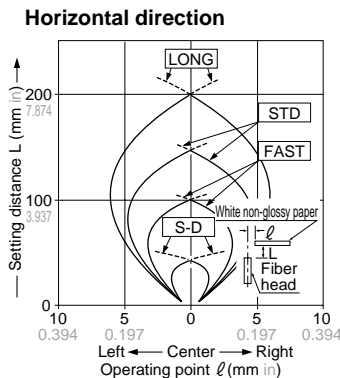

FD-G4 Reflective type

FD-G6 Reflective type

FD-EG1 Reflective type

FD-EG2 Reflective type

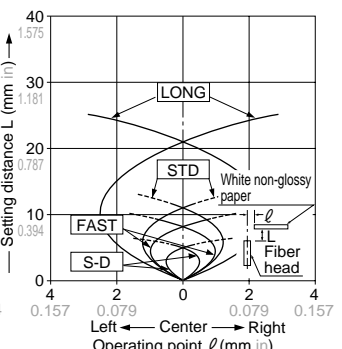
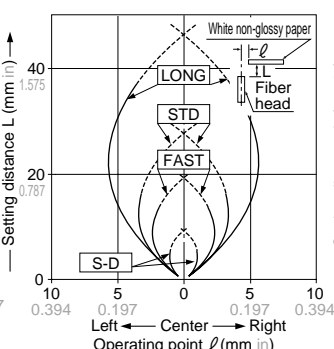
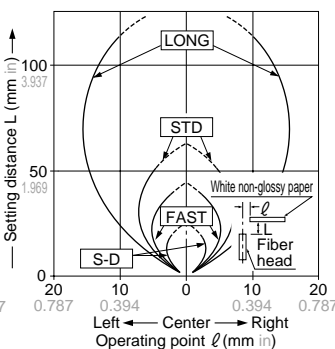
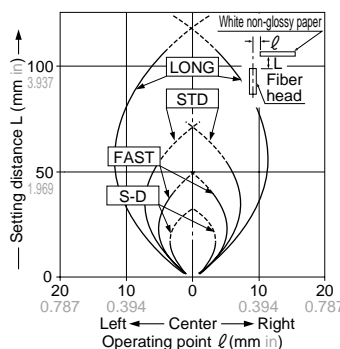

SENSING CHARACTERISTICS (TYPICAL)

The following sensing characteristics pertain to the red LED type. Please contact our office for the sensing characteristics pertaining corresponding to types other than the red LED or to types not mentioned here.

Sensing fields

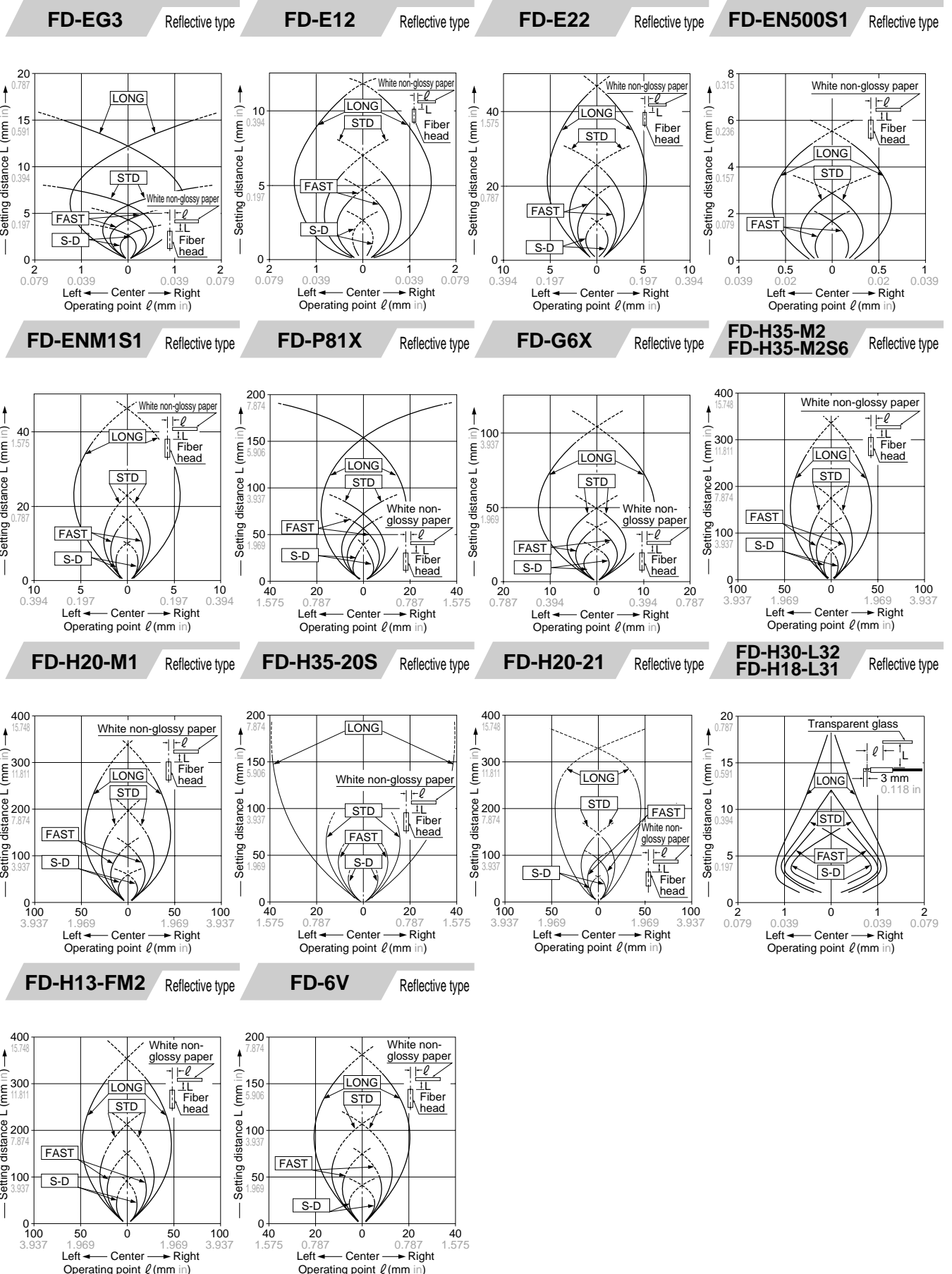

FIBER SENSORS
 Fiber Selection
 FX-301
 Digital Setting
 FX-302
 FX-303
 Bank Selection Unit
 FX-CH
 Manually Set
 FX-311
 FX-11A
 Color Detection
 FX-10

FX-301

PRECAUTIONS FOR PROPER USE

Refer to p.1135~ for general precautions, and to the 'PRO Mode Operation Guide' or 'SUNX fiber sensor home page' (<http://www.fiber-sensor.com>) for details pertaining to operating instructions for the amplifier.

Amplifier



This product is not a safety sensor. Its use is not intended or designed to protect life and prevent body injury or property damage from dangerous parts of machinery. It is a normal object detection sensor.

Mounting

How to mount the amplifier

- Fit the rear part of the amplifier on a 35 mm 1.378 in width DIN rail.
- Press down the front part of the mounting section of the amplifier on the 35 mm 1.378 in width DIN rail.

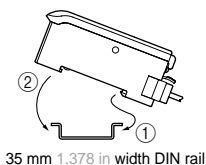

How to remove the amplifier

- Push the amplifier forward.
- Lift up the front part of the amplifier to remove it.

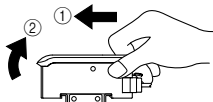

Note: Take care that if the front part is lifted without pushing the amplifier forward, the hook on the rear portion of the mounting section is likely to break.

How to connect the fiber cables

- Snap the fiber lock lever down.
- Insert fiber cables slowly into the inlets until they stop. (Note 1)
- Return the fiber lock lever to the original position, till it stops.

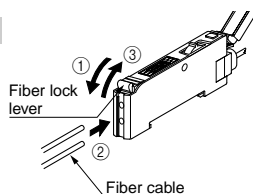

Notes: 1) In case the fiber cables are not inserted to a position where they stop, the sensing range reduces.
2) With the coaxial reflective type fiber, such as **FD-G4** or **FD-FM2**, insert the single-core fiber cable into the beam-emitting inlet and the multi-core fiber cable into the beam-receiving inlet. If they are inserted in reverse, the sensing accuracy will deteriorate.

Connection

- Make sure that the power supply is off while connecting or disconnecting the quick-connection cable.

Connection method

- Holding the connector of the quick-connection cable, align its projection with the groove at the top portion of the amplifier connector.
- Insert the connector till a click is felt.

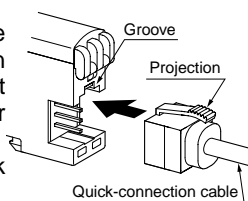

Disconnection method

- Pressing the projection at the top of the quick-connection cable connector, pull out the connector.

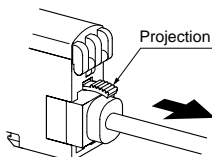

Note: Take care that if the connector is pulled out without pressing the projection, the projection may break. Do not use a quick-connection cable whose projection has broken. Further, do not pull by holding the cable, as this can cause a cable-break.

Part description

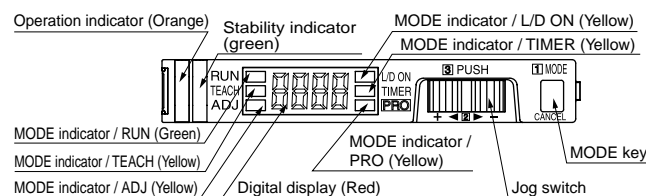

Cascading amplifiers

- Make sure that the power supply is off while cascading or removing the amplifier.
- Make sure to check the allowable ambient temperature, as it depends on the number of amplifiers connected in cascade.
- In case two, or more, amplifiers are connected in cascade, make sure to mount them on a DIN rail.
- When connecting in cascade, mount the amplifiers close to each other, fitting them between the optional end plates (**MS-DIN-E**) mounted at the two ends.
- When the amplifiers move on the DIN rail depending on the attaching condition, fitting them between the optional end plates (**MS-DIN-E**) mounted at the two ends.
- Up to maximum 15 amplifiers can be added (total 16 amplifiers connected in cascade.)
- When connecting more than two amplifiers in cascade, use the sub cable (**CN-71-C**) as the quick-connection cable for the second amplifier onwards.
- Between the **FX-301B(P)/G(P)/H(P)** and the **FX-301(P)**, the setting status copy function via communication signal cannot be used. If coupling these, please arrange identical models one at a time.

Cascading method

- Mount the amplifiers, one by one, on the 35 mm 1.378 in width DIN rail. (For details, refer to 'Mounting'.)
- Slide the sub units next to the main unit, and connect the quick-connection cables.
- Mount the optional end plates (**MS-DIN-E**) at both the ends to hold the amplifiers between their flat sides.
- Tighten the screws to fix the end plates (**MS-DIN-E**).

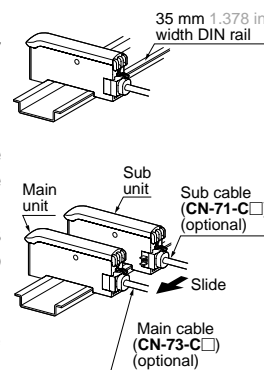

Dismantling

- Loosen the screws of the end plates (**MS-DIN-E**).
- Remove the end plates (**MS-DIN-E**).
- Slide the sub units and remove them one by one. (For details, refer to 'Mounting'.)

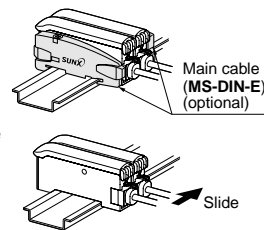

Operation procedure

- When the power supply is switched on, communication self-check is carried out and normal condition is displayed [MODE indicator / RUN (green) lights up and the digital display shows incident light intensity].
- When MODE key is pressed, the mode changes as per the diagram below.

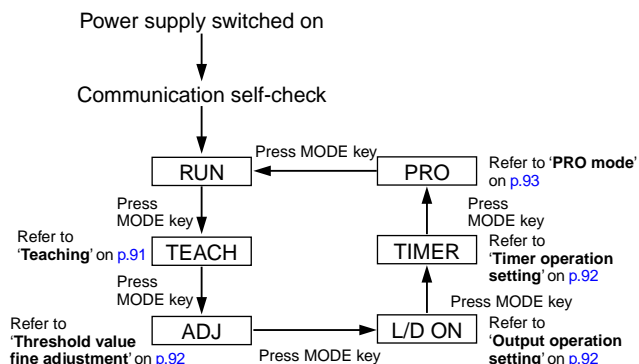

When jog switch is pressed, the setting is confirmed. When MODE key is pressed for 2 sec., or more, the sensor returns to the RUN mode. Cancellation is possible by pressing MODE key during setting.

PRECAUTIONS FOR PROPER USE

Refer to p.1135~ for general precautions, and to the 'PRO Mode Operation Guide' or 'SUNX fiber sensor home page' (<http://www.fiber-sensor.com>) for details pertaining to operating instructions for the amplifier.

Amplifier

Teaching

- The threshold values can be set by 2-level teaching, limit teaching or full-auto teaching, when the MODE indicator / TEACH (yellow) lights up.

In case of 2-level teaching

- This is the method of setting the threshold value by teaching two levels, corresponding to the object present and object absent conditions. Normally, setting is done by this method.

Step	Description	Display
①	Set the fiber within the sensing range. Press MODE key to light up MODE indicator / TEACH (yellow).	
②	Press jog switch in the object present condition. If the teaching is accepted, the read incident light intensity blinks in the digital display. Thru-beam type Reflective type	
③	MODE indicator / TEACH (yellow) blinks. Press jog switch in the object absent condition. Thru-beam type Reflective type	
④	If the teaching is accepted, the read incident light intensity blinks in the digital display and the threshold value is set at the mid-value between the incident light intensities in the object present and the object absent conditions. After this, the judgment on the stability of sensing is displayed. • In case stable sensing is possible: 'Good' is displayed. Stability indicator (green) blinks. • In case stable sensing is not possible: 'Bad' blinks. Stability indicator (green) is off.	
⑤	The threshold value is displayed.	
⑥	'....' blinks in the digital display.	
⑦	The incident light intensity appears in the digital display and the setting is complete.	

Note: Do not move or bend the fiber cable after the sensitivity setting. Detection may become unstable.

In case of full auto-teaching FX-301B(P)/G(P)/H(P) only

- Full auto-teaching is used when it is desired to set the threshold value without stopping the assembly line, with the object in the moving condition.

Step	Description	Display
①	Set the fiber within the sensing range. Press MODE key to light up MODE indicator / TEACH (yellow).	
②	Press the jog switch continuously for 0.5 sec. or more with the object moving on the assembly line. (The incident light intensity is displayed during sampling.)	
③	'Auto' is displayed on the digital display. Release the jog switch when the object has passed.	
④	If the teaching is accepted, the read incident light intensity blinks in the digital display and the threshold value is set at the mid-value between the incident light intensities in the object present and the object absent conditions. After this, the judgment on the stability of sensing is displayed. • In case stable sensing is possible: 'Good' is displayed. Stability indicator (green) blinks. • In case stable sensing is not possible: 'Bad' blinks. Stability indicator (green) is off.	
⑤	The threshold value is displayed.	
⑥	'....' blinks in the digital display.	
⑦	The incident light intensity appears in the digital display and the setting is complete.	

Notes: 1) The threshold value's shift amount can be selected in PRO mode. Refer to the 'SUNX fiber sensor home page' (<http://www.fiber-sensor.com>) for more details pertaining to setting instructions. (Increments of 5% between -45 and 45% for setting possible, 0% default.)
2) Do not move or bend the fiber cable after the sensitivity setting. Detection may become unstable.

In case of limit teaching

- This is the method of setting the threshold value by teaching only the object absent condition (stable incident light condition). This is used for detection in the presence of a background body or for detection of small objects.

Step	Description	Display
①	Set the fiber within the sensing range. Press MODE key to light up MODE indicator / TEACH (yellow).	
②	Press jog switch in the object absent condition. If the teaching is accepted, the read incident light intensity blinks in the display. Thru-beam type Reflective type	
③	MODE indicator / TEACH (yellow) blinks. Turn jog switch to the '+' side or '-' side.	
④	If jog switch is turned to the '+' side, '+' scrolls (twice) the display from right to left, and the threshold level is shifted to a value approx. 15% higher (lower sensitivity) than that set at ②. (Note 1) This is used in case of reflective type fibers. If jog switch is turned to the '-' side, '-' scrolls (twice) the display from left to right, and the threshold level is shifted to a value approx. 15% lower (higher sensitivity) than that set at ②. (Note 1) This is used in case of thru-beam type fibers.	
	<p>High Threshold value 100% 15% 15% 0 Low</p> <p>OFF ON ON OFF Turn to '+' side Turn to '-' side</p> <p>Threshold value Incident light intensity with object absent Threshold value</p>	
⑤	After this, the judgment on whether the setting shift amount can be shifted or not is displayed. • In case shifting is possible: 'Good' blinks. • In case shifting is not possible: 'Bad' blinks.	
⑥	The threshold value is displayed.	
⑦	'....' blinks in the digital display.	
⑧	The incident light intensity appears in the digital display and the setting is complete.	

Notes: 1) The approx. 15% amount of shift is the initial value. The amount of shift can be changed in the PRO mode from approx. 5 to 80% (5% step). Refer to the 'Fiber Sensor Guide Book' or 'SUNX fiber sensor home page' (<http://www.fiber-sensor.com>) for more details pertaining to setting instructions.
2) Do not move or bend the fiber cable after the sensitivity setting. Detection may become unstable.

Please refer to p.624 for setting of threshold value when used in combination with liquid level sensing fiber **FD-F8Y** and to p.618 for setting of threshold value when used in combination with pipe-mountable liquid level sensing fiber **FD-F4**, **FD-F9**.





FIBER SENSORS
Fiber Selection
Digital Setting
FX-301
FX-302
FX-303
Bank Selection Unit
FX-CH
Manually Set
FX-311
Analog Output
FX-11A
Color Detection
FZ-10

PRECAUTIONS FOR PROPER USE



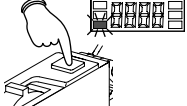
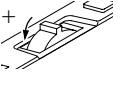
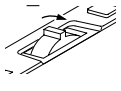

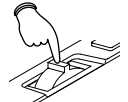

Refer to p.1135~ for general precautions, and to the 'PRO Mode Operation Guide' or 'SUNX fiber sensor home page' (<http://www.fiber-sensor.com>) for details pertaining to operating instructions for the amplifier.

Amplifier

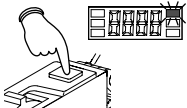
Threshold value fine adjustment

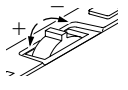
Step	Description	Display
①	Press MODE key to light up MODE indicator / ADJ (yellow). 	—
②	In case the threshold value is to be increased (sensitivity to be reduced), turn the jog switch to the '+' side to increase the threshold value slowly. If the jog switch is turned continuously to the '+' side, the threshold value increases rapidly.  In case the threshold value is to be decreased (sensitivity to be increased), turn the jog switch to the '-' side to decrease the threshold value slowly. If the jog switch is turned continuously to the '-' side, the threshold value decreases rapidly. 	 ↓  or  ↓ 
③	When jog switch is pressed, the threshold value is confirmed. 	—

Output operation setting

Step	Description	Display
①	Press MODE key to light up MODE indicator / L/D ON (yellow). 	 Displays present setting
②	If the jog switch is turn to the '+' or '-' direction, the output operation setting will change. 	Light state  ↑ Dark state 
③	When jog switch is pressed, the threshold value is confirmed. 	 Displays selected setting

Timer operation setting

- The setting for whether the timer is used or not can be done when MODE indicator / TIMER (yellow) lights up.
- 10 ms OFF-delay (initial value) timer is automatically set when the timer is set to be used.
- Further, an OFF-delay (initial value) which is useful when the response of the connected device is slow, etc., an ON-delay which is useful to detect only objects taking a long time to travel, and ONE SHOT, which is useful when the input specifications of the connected device require a signal of a fixed width, are possible with the **FX-301** series. Refer to the 'Fiber Sensor Guide Book' or 'SUNX fiber sensor home page' (<http://www.fiber-sensor.com>) for the setting method of the OFF-delay, ON-delay and ONE SHOT timer intervals.

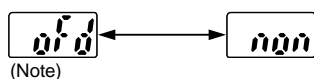

Note: The OFF-delay timer interval set in the PRO mode is displayed. Refer to the 'Fiber Sensor Guide Book' or 'SUNX fiber sensor home page' (<http://www.fiber-sensor.com>) for more details.

Key-lock function

- With the **FX-301B(P)/G(P)/H(P)**, if jog switch and MODE key are pressed for more than 3 sec. at the same time in 'RUN' mode condition, the key operations are locked, and only the threshold value confirmation function or the adjust function (valid only when the adjust lock function is canceled) is valid. To cancel the lock function, press both the keys for more than 3 sec. once again.

Wiring

- Make sure that the power supply is off while wiring.
- Verify that the supply voltage variation is within the rating.
- Take care that if a voltage exceeding the rated range is applied, or if an AC power supply is directly connected, the sensor may get burnt or damaged.
- If power is supplied from a commercial switching regulator, ensure that the frame ground (F.G.) terminal of the power supply is connected to an actual ground.
- In case noise generating equipment (switching regulator, inverter motor, etc.) is used in the vicinity of this product, connect the frame ground (F.G.) terminal of the equipment to an actual ground.
- Take care that short-circuit or wrong wiring of the load may burn or damage the sensor.
- Do not run the wires together with high-voltage lines or power lines or put them in the same raceway. This can cause malfunction due to induction.
- Ensure that an isolation transformer is utilized for the DC power supply. If an auto transformer is utilized, the main amplifier or power supply may be damaged.
- Make sure to use the optional quick-connection cable for the connection of the amplifier. Extension up to total 100 m 328.084 ft is possible with 0.3 mm², or more, cable. However, in order to reduce noise, make the wiring as short as possible.

Others

- Do not use during the initial transient time (0.5 sec. approx.) after the power supply is switched on.
- Take care that the sensor is not directly exposed to fluorescent light from a rapid-starter lamp or a high frequency lighting device, as it may affect the sensing performance.
- This sensor is suitable for indoor use only.
- Avoid dust, dirt, and steam.
- Take care that the product does not come in direct contact with water, oil, grease, or organic solvents, such as, thinner, etc.
- This sensor cannot be used in an environment containing inflammable or explosive gasses.
- Never disassemble or modify the sensor.

PRECAUTIONS FOR PROPER USE

Refer to p.1135~ for general precautions, and to the 'PRO Mode Operation Guide' or 'SUNX fiber sensor home page' (<http://www.fiber-sensor.com>) for details pertaining to operating instructions for the amplifier.

Amplifier

PRO mode

- Refer to the 'Fiber Sensor Guide Book' for more details pertaining to the PRO mode settings and procedures.



- The above can also be download from 'SUNX fiber sensor homepage' (<http://www.fiber-sensor.com>)
- PRO settings can be done when MODE indicator / PRO (yellow) lights up.

Table for PRO mode settings

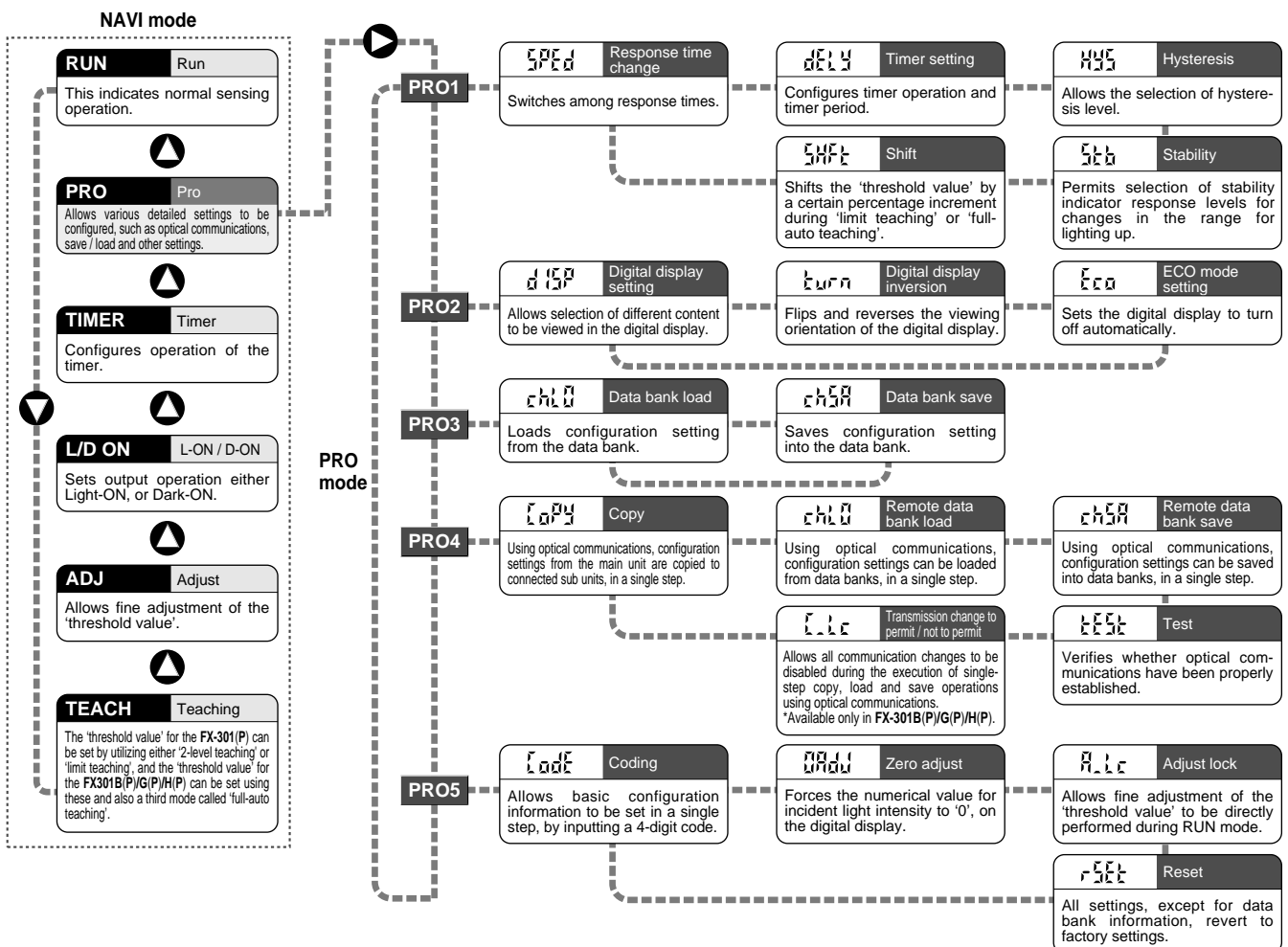

FX-301

PRECAUTIONS FOR PROPER USE

Refer to p.1135~ for general precautions.

Fiber

Mounting

- The tightening torque must not exceed the values given below.

Mounting with a nut (threaded head type)

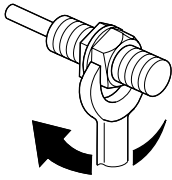

	Tightening torque
M3	0.39 N·m
M4	0.58 N·m (350 °C 662 °F heat-resistant fiber and FT-H20W-M□: 0.98 N·m, FD-H35-20S: 0.58 N·m)
M5 M6	0.98 N·m (350 °C 662 °F heat-resistant fiber: 1.96 N·m)
M14	1.47 N·m

Mounting with a set screw

Set screw (cup point)
M3 or less

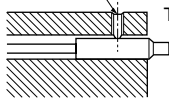

Tightening torque: 0.29 N·m or less
(FT-SFM2L: 0.19 N·m
FT-H20W-M□: 0.49 N·m)

- Fibers for which the tightening section has been specified should be fixed at ℓ mm from the tightening section tip. (However, for FT-K8, FT-KV8, FT-WKV8 and FT-V10 'ℓ' indicates the range over which tightening cannot be done.)

Set screw (cup point)
M3 or less

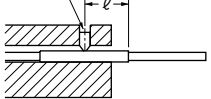

<FT-K8, FT-KV8, FT-WKV8, FT-V10>

Tightening prohibited range

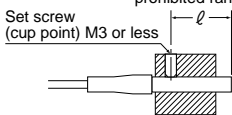

	ℓ (mm in)	Tightening torque
FT-PS1	3 0.118	0.1 N·m
FD-E12	4 0.157 (Note 1)	0.29 N·m
FT-V22 FT-41, FD-V41 FT-SFM2SV2	10 0.394	0.19 N·m
FD-EG1	10 0.394	0.29 N·m
FT-WV42 FD-WV42	15 0.591	0.29 N·m
FD-SFM2SV2	7 0.276	0.34 N·m
FT-KV8, FT-WKV8 FT-V10	13 0.512	0.3 N·m
FT-K8	12 0.472	

Notes 1): Excluding the sleeve.

2): When installing, make sure to use screws smaller than the fiber diameter.

Mounting array fiber

- Using M3 screws, the tightening torque should be 0.58 N·m or less.

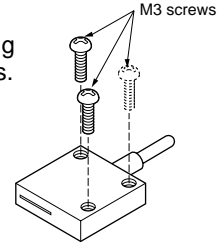

Mounting FD-L4

- Using M2.6 (length 12 mm 0.472 in) screws with washers (accessory), the tightening torque should be 0.3 N·m or less.

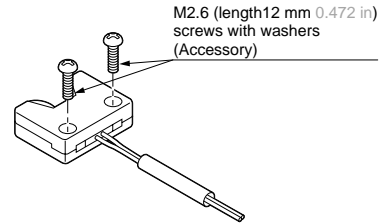

Mounting FD-WL41 / FD-L41 and FD-WL42 / FD-L42

- Using M3 countersunk head screws, the tightening torque should be 0.3 N·m or less.

<FD-WL41 / FD-L41>

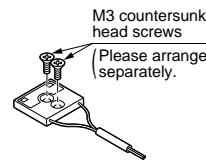

<FD-WL42 / FD-L42>



Mounting FD-L43

- Using M3 countersunk head screws, the tightening torque should be 0.3 N·m or less.

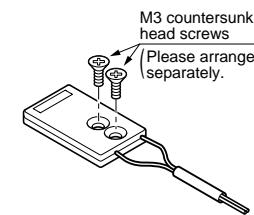

PRECAUTIONS FOR PROPER USE

Refer to p.1135~ for general precautions.

Fiber

Mounting FT-Z8□ and FT-WZ8□

- Mount the fiber head by using the enclosed set of screws. The tightening torque should be 0.15 N·m or less
- If the fiber head is mounted in places subject to vibrations or shocks, use a screw-locking adhesive, etc.
- Mount each fiber head as given below.

<FT-Z8 / FT-WZ8 (Front sensing type)>

In case of tapping the mounting section

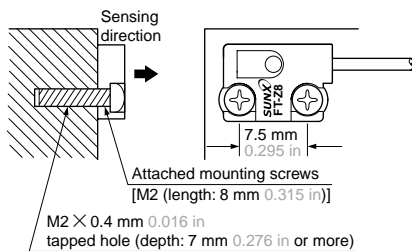

In case of using attached screw and nut

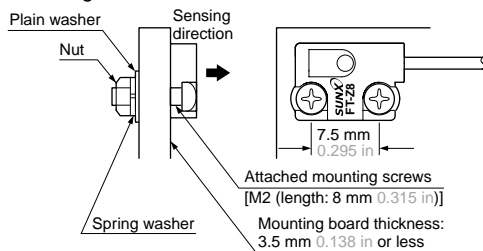

<FT-Z8E / FT-WZ8E (Side sensing type)>

In case of tapping the mounting section

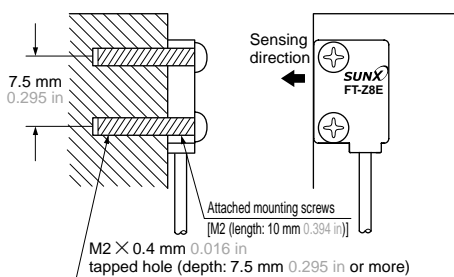

In case of using attached screw and nut

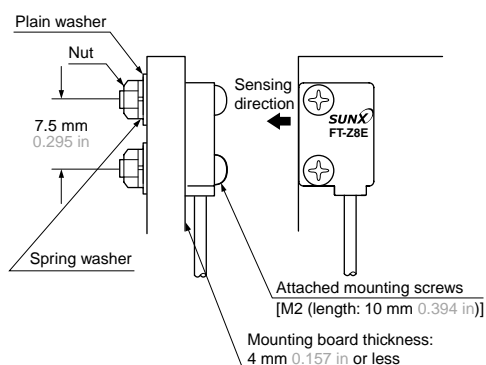

<FT-Z8H / FT-WZ8H (Top sensing type)>

In case of tapping the mounting section

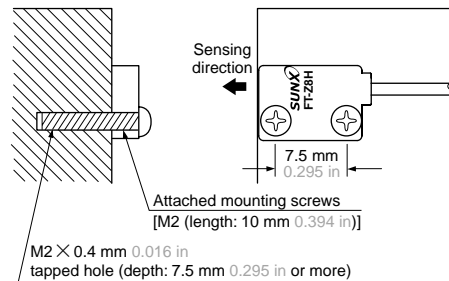

In case of using attached screw and nut

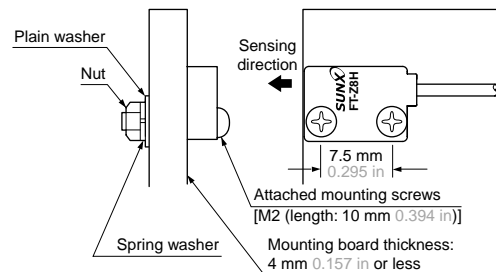

Mounting FT-Z802Y

- Using M3 pan head screws, the tightening torque should be 0.3 N·m or less.

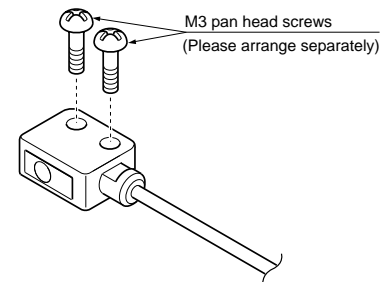

Mounting FD-WKZ1

<If not using the attached mounting brackets>

- Use M3 or less set screws (cup point), and affix the head within 15 mm (0.591 in) from the tip of the fiber head. Do not exceed a torque of 0.3 N·m when tightening.

<If using the attached mounting brackets>

- The head can be affixed even without using the set screws.
- If using the set screws, use M3 set screws (cup point) to affix and do not exceed a torque of 0.05 N·m when tightening.

Mounting FD-A15

- Using M3 screws, the tightening torque should be 0.3 N·m or less.

Mounting FD-H30-L32 / FD-H18-L31

- Using M3 screws, the tightening torque should be 3 N·m or less.

PRECAUTIONS FOR PROPER USE

Refer to p.1135~ for general precautions.

Fiber

Narrow beam type fiber mounting

- Take care that, since the aperture angle of this product is very narrow, the beam may not be received depending upon the setting. At the time of installation, determine a reference plane, as shown in the figure below, and taking sufficient care against beam misalignment or tilt, install the emitting and receiving fibers so that they are parallel.

<FT-K8>

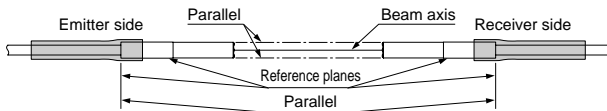

<FT-KV8 / FT-WKV8>

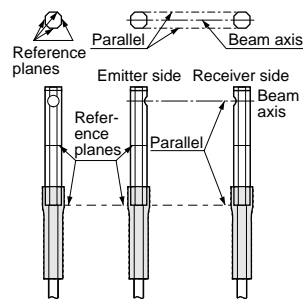

Thru-beam type wide beam fiber mounting

- Take care that, since the aperture angle of this product is very narrow, the beam may not be received depending upon the setting. At the time of installation, determine a reference plane, as shown in the figure below, and taking sufficient care against beam misalignment or tilt, install the beam-emitting and receiving fibers so that they are parallel.

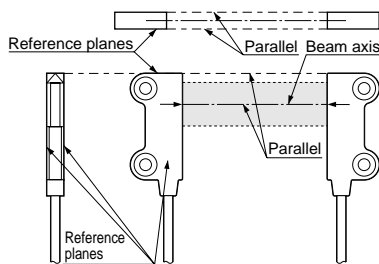

- Install the fiber using M3 countersunk head screws. The tightening torque should be 0.3 N·m or less.

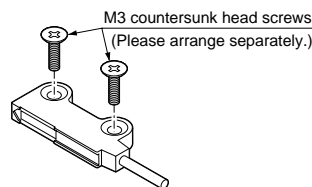

- Further, when using the fiber at places having intense vibrations, use a screw-locking adhesive, etc.
- If mineral oil or solvent containing mineral oil component adheres to the sensing surface, the lens may be deformed. Take sufficient care to handle them.

Method of fixing fiber cable

- If fixing the fiber cable in position, make sure that it is set in a manner as shown below, so that no load is applied on the fiber. (Excluding FT-H35-M2, FT-H35-M2S6, FD-H35-M2 and FD-H35-M2S6)

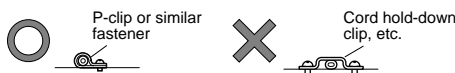

Connection with reflective coaxial type fiber

- With reflective coaxial type fiber, insert the center fiber cable (single-core) into the beam-emitting inlet and the outer fiber cable (multi-core) into the beam-receiving inlet.

FD-H35-M2 or FD-H20-M1 is marked 'P' on the beam-emitting fiber cable and 'D' on the beam-receiving fiber cable.
 FD-WG4, FD-WSG4 and FD-G4, FD-G6, FD-G6X are composed of beam-emitting and beam-receiving fiber cables that are different in diameter.
 FD-G500, FD-EG1, FD-EG2, FD-EG3, FD-E22, FD-H20-21 and FD-ENM1S1 are marked P on the beam-emitting fiber cable.

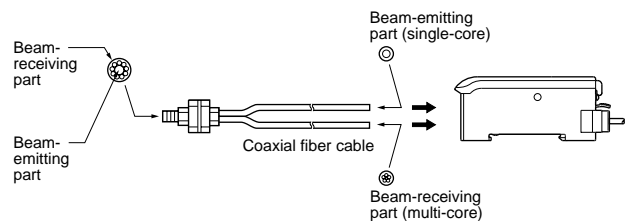

- Notes: 1) In case the fiber cables are not inserted to a position where they stop, the sensing range reduces.
 2) Before connecting fiber cables to the amplifier, mount the fiber attachments on their ends.

Fiber cable bending radius

- If the fiber cable is bent at a smaller bending radius than allowable bending radius, the sensing range decreases due to beam attenuation.

For a allowable bending radius of 25 mm (0.984 in)

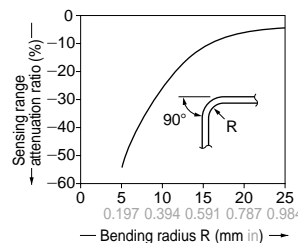

Note: Please note that the 350 °C 662 °F heat-resistant fibers, vacuum-resistant and chemical-resistant fibers cannot bend less than the allowable bending radius.

How to bend sleeve

- The bending radius must be R10 mm R0.394 in or more. Please bend gradually using the fiber bender (FB-1) or a round bar of φ20 mm φ0.787 in or more.

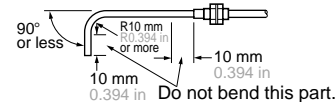

- Note: Do not bend the sleeve of side-view type, narrow beam type, narrow-view type and ultra-small diameter type fiber.

Use of heat-resistant type fiber

- Use by keeping 150 mm 5.906 in, or more, of the heat-resistant fiber cable part at normal temperature.

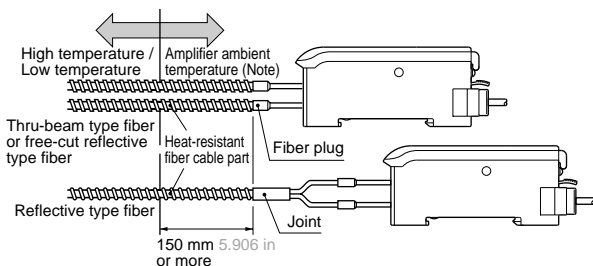

- Protect the amplifier from heat radiation or hot air.
- With the 350 °C 662 °F heat-resistant type fiber, the surface of the fiber head or the spiral may be discolored by heat. However, this does not affect its performance.

PRECAUTIONS FOR PROPER USE

Refer to p.1135~ for general precautions.

Fiber

Fiber attachments (FX-AT□)

Product outline

• When the beam-emitting and beam-receiving fiber cables are inserted into the fiber sensor amplifier (FX-301/302/303/311 series etc.), the enclosed fiber attachment (FX-AT2/AT3/AT4/AT5/AT6) facilitates insertion of the fiber cables and reduces the possibility of incorrect fiber cable insertion.

Cautions

• Take care that FX-AT2, FX-AT3, FX-AT4, FX-AT5 and FX-AT6 cannot be used with fiber sensor amplifiers having a pitch, between the beam-emitting and the beam-receiving fiber cables, other than 7 mm 0.276 in. In case of fiber sensor amplifiers having a pitch other than 7 mm 0.276 in, please use attachments FX-AT10 or FX-AT13. (accessory)

Component description

<FX-AT2>

Attachment for fixed-length fiber: orange



<FX-AT3>

Attachment for $\phi 2.2$ mm $\phi 0.087$ in fiber: clear orange



<FX-AT4>

Attachment for $\phi 1$ mm $\phi 0.039$ in fiber: black



<FX-AT5>

Attachment for $\phi 1.3$ mm $\phi 0.051$ in fiber: gray



<FX-AT6>

Attachment for $\phi 1$ mm / $\phi 1.3$ mm $\phi 0.039$ in / $\phi 0.051$ in mixed fiber
(for $\phi 1$ mm $\phi 0.039$ in fiber: black,
for $\phi 1.3$ mm $\phi 0.051$ in fiber: gray)



<FX-AT10>

Attachment for $\phi 1$ mm $\phi 0.039$ in fiber: black

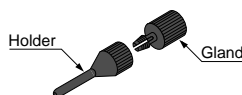

This is enclosed by FX-AT4.

<FX-AT13>

Attachment for $\phi 1.3$ mm $\phi 0.051$ in fiber: gray

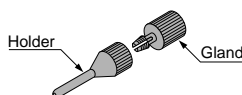

This is enclosed by FX-AT5.

Mounting

<FX-AT2>

- Mount the plug part of the fiber cables in FX-AT2, as shown in the figure below. (The resin plug has a groove to hold it in place.)
- Connect the fiber cables, in condition ①, to the fiber sensor amplifier.

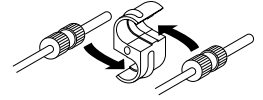

<FX-AT3>

- Confirm that the fiber lock button of FX-AT3 is in unlock side.
- Insert the fiber cables one by one, in condition ①.
- After inserting, press down the fiber lock button. The fiber cables are fixed at the desired position. (In order to unlock the fiber cables, press the fiber lock button towards unlock direction from the opposite side.)
- Insert the fiber cables into the holes for $\phi 2.2$ mm $\phi 0.087$ in fiber cables of the fiber cutter (FX-CT2) from the direction shown in the figure right.
- Cut both fiber cables simultaneously. (At this time, place the attachment without any gap against the fiber cutter. The fiber cables will be cut at a position approx. 10.5 mm 0.413 in from the tip of the fiber cable.)
- After cutting, connect the fiber cables to the fiber sensor amplifier immediately.

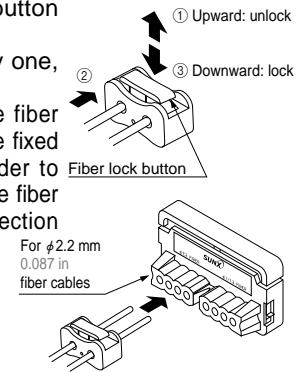

<FX-AT4, FX-AT5, FX-AT6>

- Mount the holders on the gland lightly.
Notes: 1) If both long holders and short holders are enclosed with the fiber, use the short holders.
2) In case of FX-AT6, match the colors of the holders and the gland. The black color is for $\phi 1.0$ mm $\phi 0.039$ in fiber cable and the gray color is for $\phi 1.3$ mm $\phi 0.051$ in fiber cable.
- Insert the fiber cables into the holders, in condition ①.
- Tighten the holders to fix the fiber cables at the desired length.
- Insert the fiber cables, in condition ③, into the holes for $\phi 1.0$ mm $\phi 0.039$ in or $\phi 1.3$ mm $\phi 0.051$ in fiber cables of the fiber cutter (FX-CT2) from direction shown in the figure right.
- Cut both fiber cables simultaneously. (At this time, insert the attachment to a position at which it stops. The fiber cables will be cut at a position approx. 0.5 mm 0.020 in from the holder.)
- After cutting, insert the fiber cables to the fiber sensor amplifier immediately.

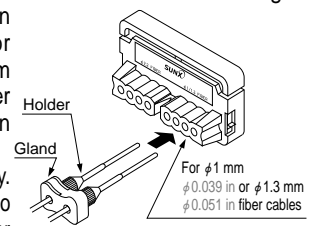

<FX-AT10, FX-AT13>

- Thread the fiber cable through the gland and holder separately, and screw the gland into the holder clockwise.
- Insert the fiber cables one by one into the holes for $\phi 1.0$ mm $\phi 0.039$ in or $\phi 1.3$ mm $\phi 0.051$ in fiber cable of the fiber cutter (FX-CT2) from the direction shown in the figure right. (At this time, insert the attachment to a position at which it stops. The fibers will be cut at a position approx. 0.5 mm 0.020 in from the holder.)

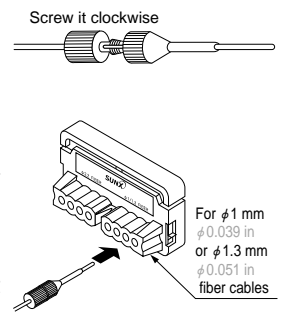

Fiber Selection

FX-301

Digital Setting
FX-302

FX-303

Bank Selection Unit
FX-CH

Manually Set
FX-311

Analog Output
FX-11A

Color Detection
FZ-10

PRECAUTIONS FOR PROPER USE

Refer to p.1135~ for general precautions.

Fiber

Fiber cutter (FX-CT2)

• To cut the fiber cables, insert them from the direction shown below.

(Fiber cable insertion direction)

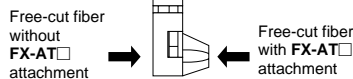

How to use fiber cutter (FX-CT2)

- Slide part (A) of the fiber cutter fully upward till it stops.
- Insert the fiber cables, mounted in the attachment, till they stop.
(Take care that there are separate fiber insertion cable holes for $\phi 2.2$ mm $\phi 0.087$ in and $\phi 1.0$ mm $\phi 0.039$ in or $\phi 1.3$ mm $\phi 0.051$ in fiber cables.)
- Slide part (A) of the fiber cutter down to cut the fibers.

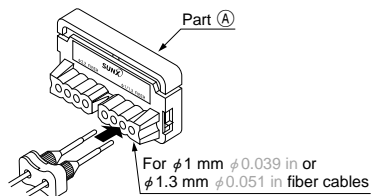

- Notes:
- The fiber cables should be cut in one stroke.
 - Once a fiber cable is cut off at a hole, do not use the hole again. If used, it degrades the cut surface quality and the detectability may deteriorate.
 - The blade cannot be replaced. Please purchase an additional fiber cutter, if required.
 - Note that the sensing range may be reduced by up to 20 % depending on the cut condition. Hence, decide the setting distance by taking sufficient margin.

Seal type slit mask for FT-WA30/A30, FT-WA8/A8

• Two types of slit masks are enclosed. (one type for FT-A30 and FT-WA30) Apply the enclosed slit mask when detecting small objects or as measures not to saturate the emitted light amount for short-range sensing. However, the sensing range is reduced when the slit mask is mounted. As the slit mask is seal type, stick it by aligning the projection of the slit mask with the upper portion of the fiber head, as shown in the figure below.

Slit masks

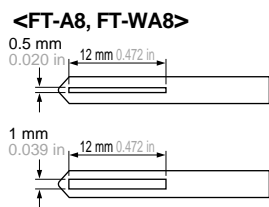

Mounting

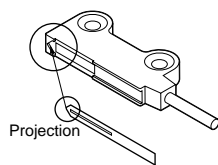

Sensing range when mounting slit mask [with FX-301(P)]

- FT-WA30/A30:** 2,500 mm 98.425 in (LONG) / 1,000 mm 39.370 in (STD) / 600 mm 23.622 in (FAST) / 200 mm 7.874 in (S-D)
- FT-WA8/A8:** 400 mm 15.748 in (LONG) / 200 mm 7.874 in (STD) / 140 mm 5.512 in (FAST) / 70 mm 2.756 in (S-D) (0.5 × 12 mm 0.020 × 0.472 in slit mask)
- FT-WA8/A8:** 800 mm 31.496 in (LONG) / 400 mm 15.748 in (STD) / 280 mm 11.024 in (FAST) / 140 mm 5.512 in (S-D) (1 × 12 mm 0.039 × 0.472 in slit mask)

Vacuum type fiber

Configuration

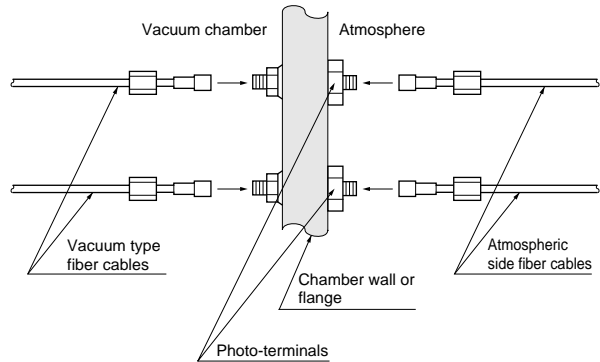

Leakage: 1.33×10^{-10} Pa·m³/sec. [He] or less

Mounting

- Make two holes on the vacuum tank wall (chamber wall or flange).

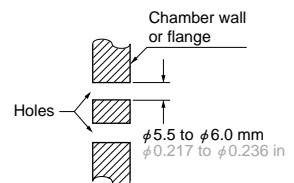

Note: The hole diameter must be from $\phi 5.5$ to $\phi 6.0$ mm $\phi 0.217$ to $\phi 0.236$ in.

- Mount the **FV-BR1** photo-terminal on the vacuum tank wall.

Notes:

- The attached O-ring must be mounted.
- The O-ring must be used at the atmospheric side.
- The tightening torque should be 0.58 N·m or less.

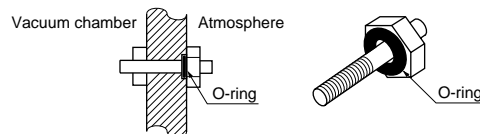

- Mount the **FT-J6** atmospheric side fibers on the atmospheric side of the **FV-BR1** photo-terminals.

Notes:

- The fixing nuts must be tightened securely. If not, the sensing range may decrease.
- The tightening torque should be 0.58 N·m or less.



- Mount the vacuum type fibers on the vacuum side of the **FV-BR1** photo-terminals.

Notes:

- The fixings rings of the vacuum type fibers must be tightened securely. If not, the sensing range may decrease.
- The tightening torque should be 0.58 N·m or less.

- Fix the fiber head of the vacuum type fiber.

Note: The maximum tightening torque should be as given below.

	Tightening torque
M2.6	0.29 N·m
M4 M6	0.58 N·m

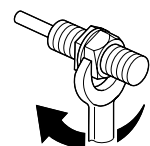

PRECAUTIONS FOR PROPER USE

Refer to [p.1135](#)~ for general precautions.

Fiber

FT-L8Y/V8Y chemical-resistant type fiber

- Do not use it in the following chemicals:
Dissolved alkali metals (Natrium, Potassium or Lithium),
Fluorine gas (F₂), ClF₃, OF₂ (including gaseous state).
- The beam axis mark is indicated on the side-view fiber.
Perform the beam alignment with the beam axis marks, on
the receiver and the emitter, facing each other.

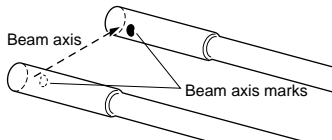

Mounting

- Use a commercial Fluorine resin joint to mount the fiber.
- The bending radius of the protective jacket should be R30 mm 1.181 in or more. It will be damaged under the value.
- The bending radius of the bear fiber should be R25 mm R0.984 in or more. The sensing range will be shortened under the value.
- Do not subject the fiber under tension.
- Although the chemical-resistant type fiber is rated for use up to +115 °C +239 °F, place 100 mm 3.937 in or more of the fiber in the normal temperature area to protect the amplifier.

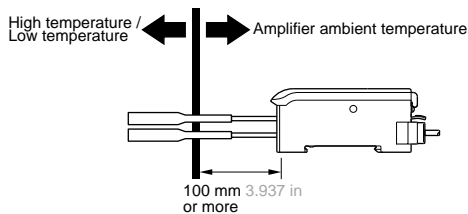
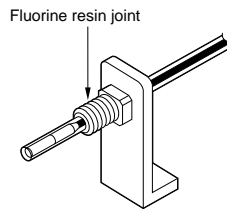

FD-F8Y liquid level sensing fiber

Mounting

- Use a commercially available fluorine resin joint, etc., to install **FD-F8Y**.

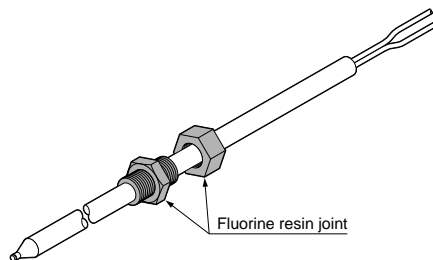

Cautions

- Take care that unclear liquid may not be sensed stably.
- Take care that the tube may stretch by maximum 2 % of the total length if it is used at a high temperature.
- Do not scratch the fiber jacket while cutting the fluorine resin tube.

Fiber Selection

FX-301

Digital Setting
FX-302

FX-303

Bank Selection Unit
FX-CH

Manually Set
FX-311

Analog Output
FX-11A

Color Detection
FZ-10

FX-301

PRECAUTIONS FOR PROPER USE

Refer to p.1135~ for general precautions.

Fiber

FD-F4□ and FD-F9□ liquid level sensing fiber

Mounting

- Mount the fiber head on a pipe with the attached tying bands and anti-slip tubes as shown in the figure below. Make sure that the release lever is retracted (position as in the fig.) before mounting. Fasten two tying bands, as shown, and cut off the excess portions.

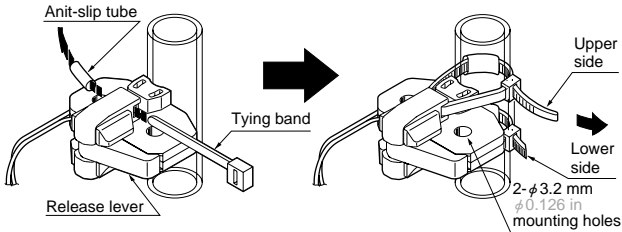

- If other tying bands are to be used, the dimension A shown in the figure below should be 2.5 mm 0.098 in or less.

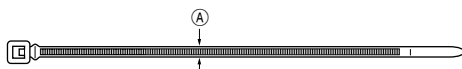

- In case of mounting using the two mounting holes, use M3 screws, plain washers, and spring washers. The tightening torque should be 0.5 N·m or less. (Please arrange the M3 screws, plain washers, and spring washers separately.)
- In case of mounting on the pipe with tying bands, the fiber position can be easily adjusted.

Adjustment

- Unlock the release lever (in the direction of the arrow).

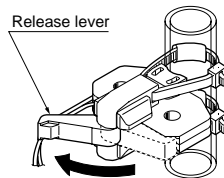

- Press the movable center holders forward to loosen the tying bands and adjust the position.

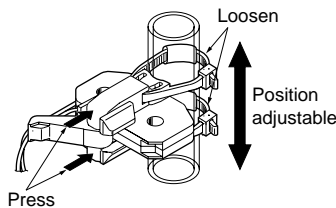

- Lock the release lever to its original place.

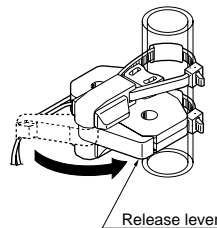

Notes: 1) Whenever the mounting position is changed, adjust the sensitivity again.
 2) The lever mechanism must be used only to adjust the position, and not for tightening the tying bands. If tying bands are tightened while the lever is open, and then the lever is locked, the fiber may be damaged.

Cautions

- Liquid in a pipe which is not transparent cannot be sensed correctly.
- Unclear or viscous liquid may not be sensed.
- Fit the fiber head to the pipe securely, otherwise the operation may be erroneous.
- Take care that no dew condenses on the pipe's sensing surface or the pipe's inside wall and no bubble attaches on the pipe's inside wall, since it can affect the operation.
- Neither the FD-F4□ or the FD-F9□ is waterproof or chemical-resistant. Installation should be avoided at any place where it could come in direct contact with water or chemicals.
- Do not apply excessive tensile force to the fiber cable.

Cautions for FX-MR2 zoom lens usage

- The spot diameter and the sensing range are adjustable by the screw-in depth as follows.

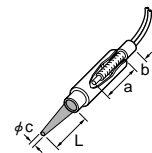
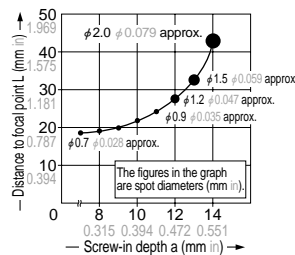

a: Screw-in depth
 b: 25 - a
 L: Distance to focal point
 φc: Spot diameter

- After FX-MR2 is set on the fiber head at the desired depth, tighten the attached nut securely.

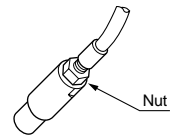

- To mount FX-MR2 with a set screw, use a M3 set screw (cup point). The tightening torque should be 0.29 N·m or less.

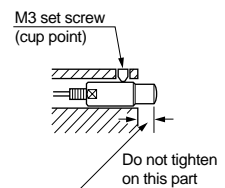

Caution for FX-MR3, FX-MR6 finest spot lens usage

- Screw FX-MR3, FX-MR6 on the fiber head until the fiber is fully inserted. The tightening torque should be 0.29 N·m or less.

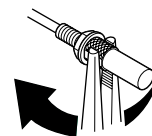

PRECAUTIONS FOR PROPER USE

Refer to p.1135~ for general precautions.

Fiber

Cautions for FX-MR5 side-view zoom lens usage

- The spot diameter and the sensing range are adjustable by the screw-in depth as follows.

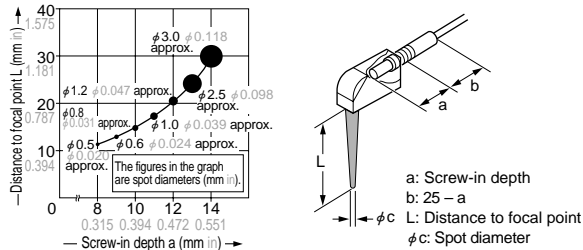

- After **FX-MR5** is set on the fiber head at the desired depth, tighten the attached nut **NT-FX-MR5** securely.

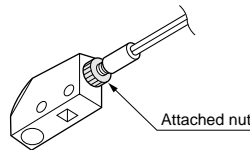

- The tightening torque should be 0.5 N·m or less when tightening **FX-MR5** with a screw.

Fitting protective tube

- The threaded head free-cut fiber can be fitted with a protective tube.

Fitting

- Insert the fiber cable into the protective tube from the sleeve side.



- Turn the fiber head to screw it on the inner thread of the sleeve.



Mounting

- The maximum tightening torque should be as given below.

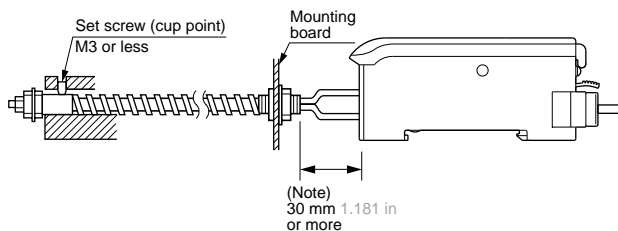

<Sleeve part>

Tightening torque:
0.58 N·m or less

<Threaded part>

Tightening torque:
0.58 N·m or less

Note: The fiber cable must be longer than the protective tube by 30 mm 1.181 in or more to connect it to the amplifier. Make sure to measure the length required before cutting.

Others

- Do not use the fiber at places having intense vibrations, as this can cause malfunction.
- Keep the fiber head surface intact. If it is scratched or spoiled, the detectability will deteriorate.
- Do not expose the fiber cable to any organic solvents. (Excluding chemical-resistant type fiber)
- Do not use the fiber head in places where it may come in direct contact with water. A water drop on the fiber head deteriorates the sensing.
- Ensure that any strong extraneous light is not incident on the receiving face of the fiber head.
- Do not apply excessive tensile force to the fiber cable.
- Take care that the sensor is not directly exposed to fluorescent light from a rapid-starter lamp or a high frequency lighting device, as it may affect the sensing performance.
- Since the sensing portion of the wide beam or narrow beam fiber is concave shaped, take care that dust or dirt does not collect on it. In case it does collect, wipe it with a dry soft cloth.

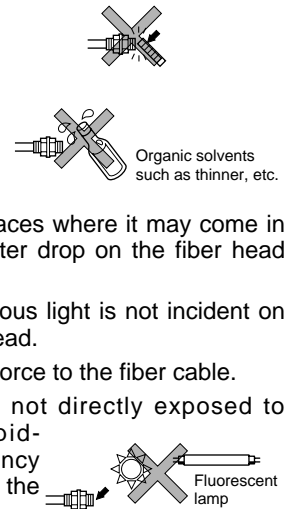

Fiber Selection

FX-301

Digital Setting
FX-302

FX-303

Bank Selection Unit
FX-CH

Manually Set
FX-311

Analog Output
FX-11A

Color Detection
FZ-10

FX-301

DIMENSIONS (Unit: mm in) The CAD data in the dimensions can be downloaded from the SUNX fiber sensor website: <http://www.fiber-sensor.com/>

FX-301 **FX-301P** **Amplifier**

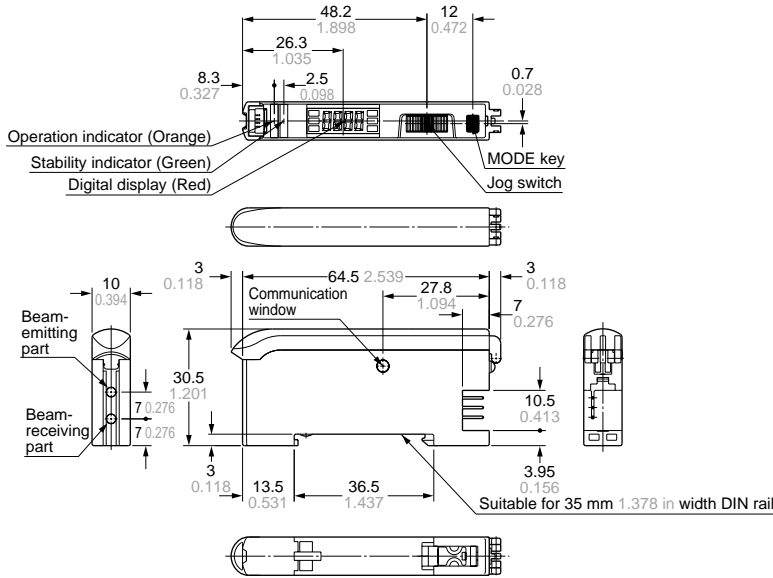

CN-73-C1 CN-73-C2 CN-73-C5 **Main cable (Optional)**

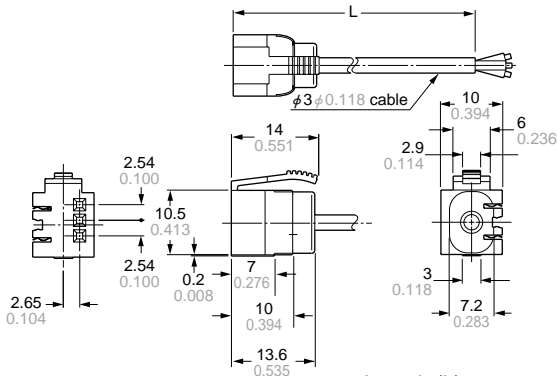

• Length (L)

Model No.	Length (mm in)
CN-73-C1	1,000 39.370
CN-73-C2	2,000 78.740
CN-73-C5	5,000 196.850

CN-71-C1 CN-71-C2 CN-71-C5 **Sub cable (Optional)**

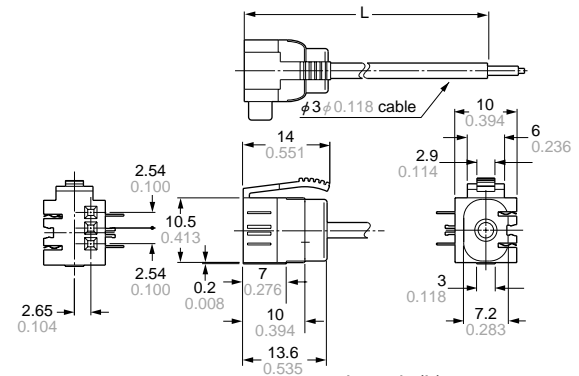

• Length (L)

Model No.	Length (mm in)
CN-71-C1	1,000 39.370
CN-71-C2	2,000 78.740
CN-71-C5	5,000 196.850

MS-DIN-2 **Amplifier mounting bracket (Optional)**

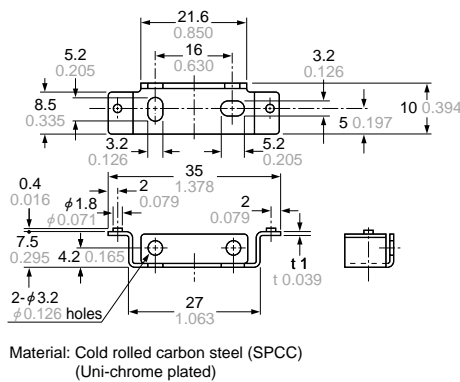

MS-DIN-E **End plate (Optional)**

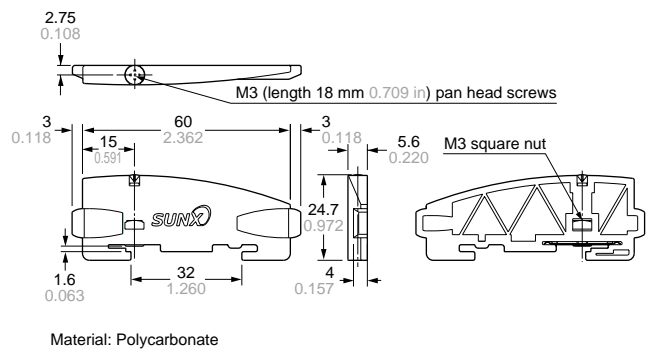

DIMENSIONS (Unit: mm in) The CAD data in the dimensions can be downloaded from the SUNX fiber sensor website: <http://www.fiber-sensor.com/>

Thru-beam type fibers

FT-FM10L ✂ Free-cut **With FX-AT3**

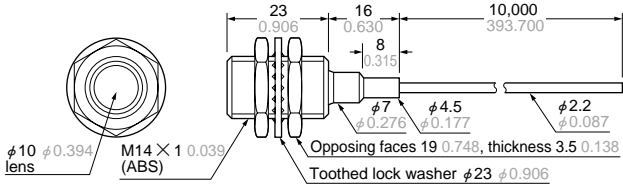

FT-SFM2L ✂ Free-cut **With FX-AT3**

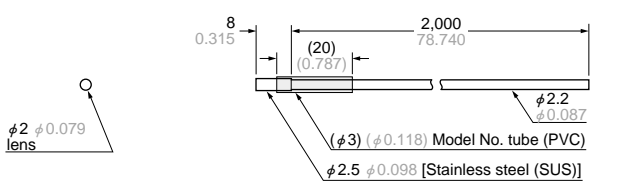

FT-B8 ✂ Free-cut **With FX-AT3**

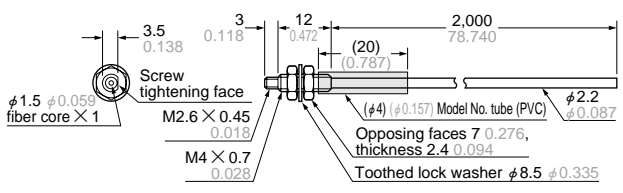

FT-NB8 ✂ Free-cut

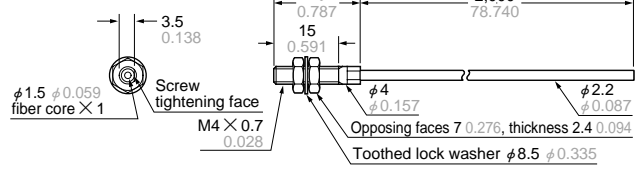

FT-FM2 ✂ Free-cut **With FX-AT3**

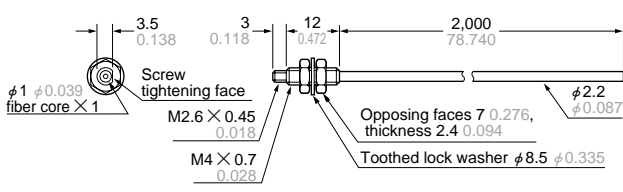

FT-FM2S ✂ Free-cut **With FX-AT3**

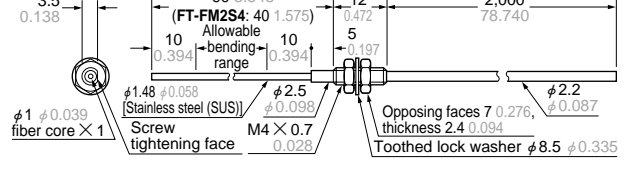

FT-T80 ✂ Free-cut **With FX-AT5**

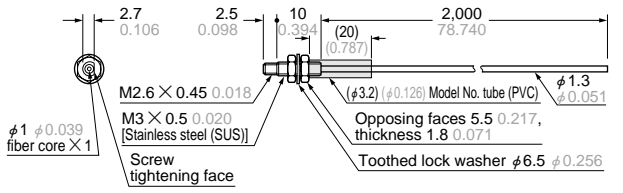

FT-SFM2 ✂ Free-cut **With FX-AT3**

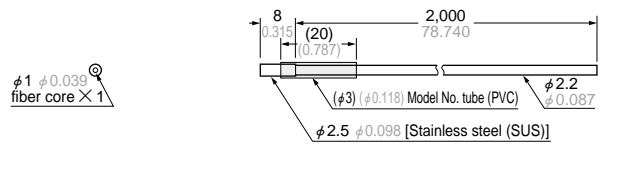

FT-N8 ✂ Free-cut

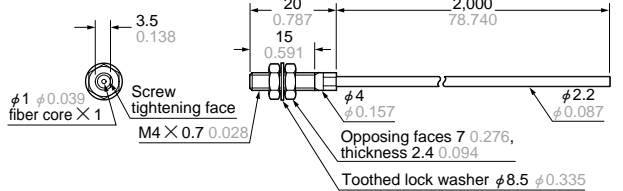

FT-NFM2 ✂ Free-cut **With FX-AT4**

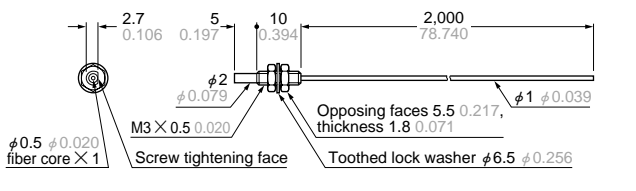

FT-NFM2S ✂ Free-cut **With FX-AT4**

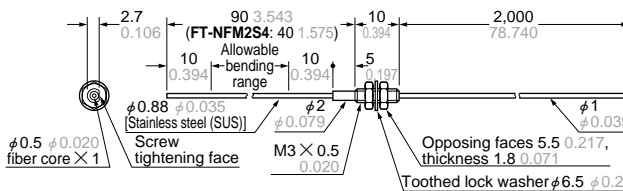

FT-SNFM2 ✂ Free-cut **With FX-AT4**

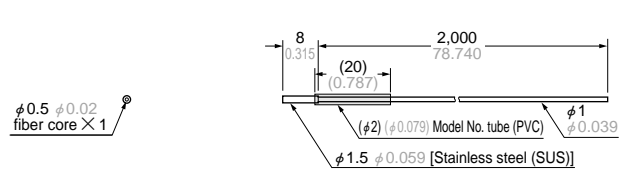

FIBER SENSORS
 Fiber Selection
FX-301
 Digital Setting
 FX-302
 FX-303
 Bank Selection Unit
 FX-CH
 Manually Set
 FX-311
 Analog Output
 FX-11A
 FZ-10

FX-301

DIMENSIONS (Unit: mm in) The CAD data in the dimensions can be downloaded from the SUNX fiber sensor website: <http://www.fiber-sensor.com/>

Thru-beam type fibers

FT-R80

Free-cut

With FX-AT3

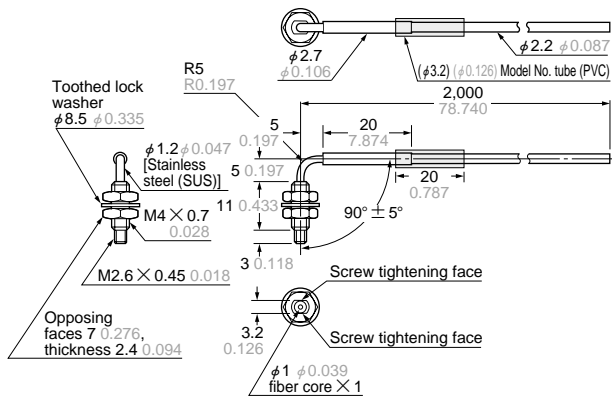

FT-V10

Free-cut

With FX-AT3

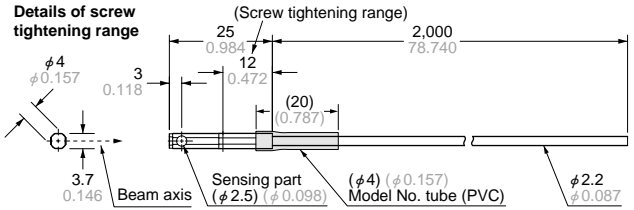

FT-SFM2SV2

Free-cut

With FX-AT3

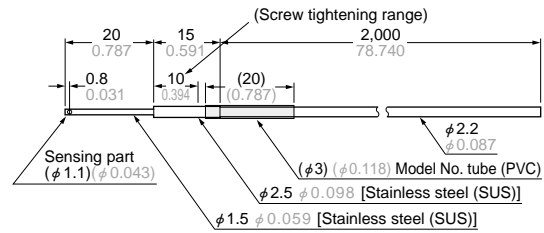

FT-V22

With FX-AT2

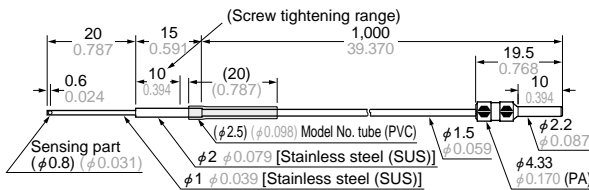

FT-V41

Free-cut

With FX-AT4

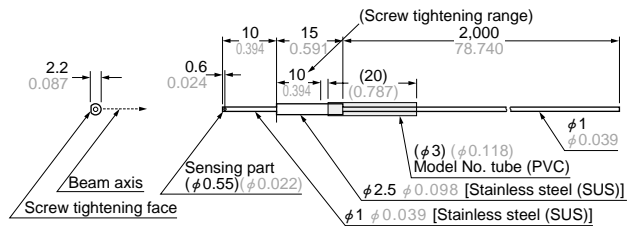

FT-WA30

Free-cut

With FX-AT3

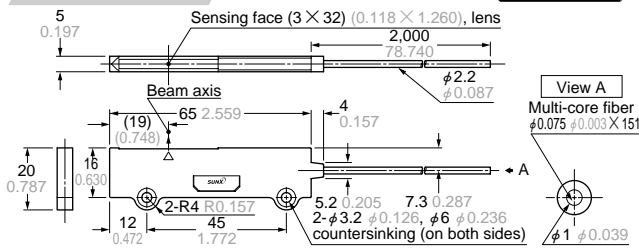

FT-WA8

Free-cut

With FX-AT3

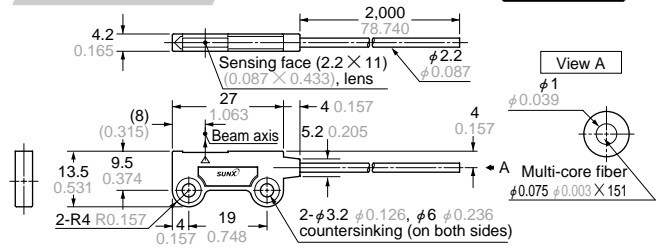

FT-WZ8H

Free-cut

With FX-AT5

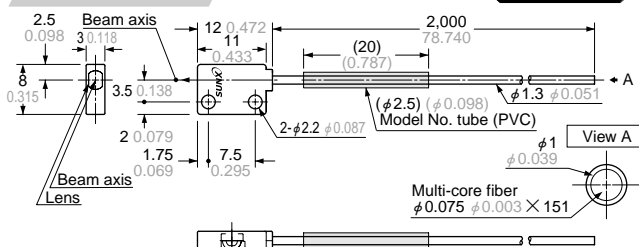

FT-WZ8E

Free-cut

With FX-AT5

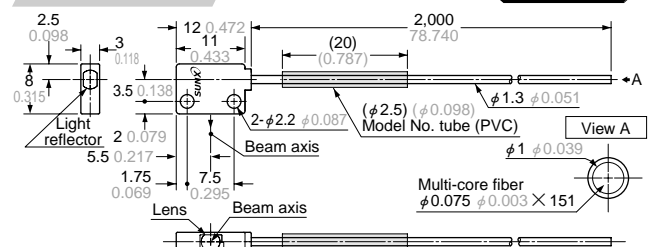

FT-WZ8

Free-cut

With FX-AT5

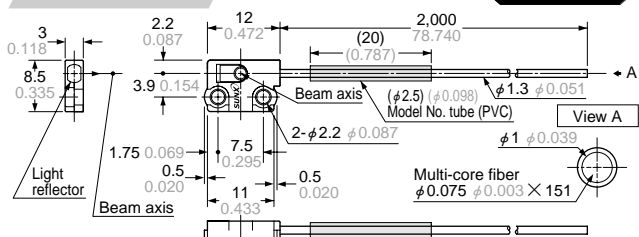

FT-WK8

Free-cut

With FX-AT3

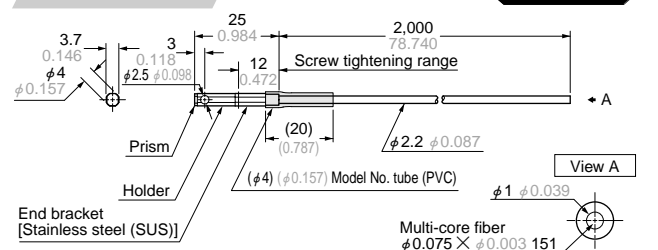

Note: The emitter and receiver are symmetric.

DIMENSIONS (Unit: mm in) The CAD data in the dimensions can be downloaded from the SUNX fiber sensor website: <http://www.fiber-sensor.com/>

Thru-beam type fibers

FT-WS8L Free-cut **With FX-AT3**

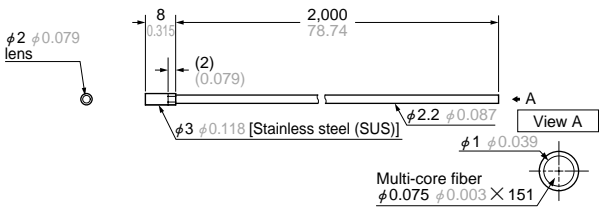

FT-W8 Free-cut **With FX-AT3**

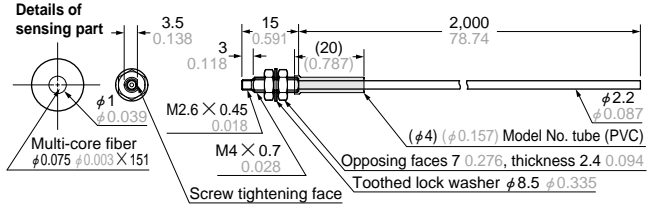

FT-WS3 Free-cut **With FX-AT3**

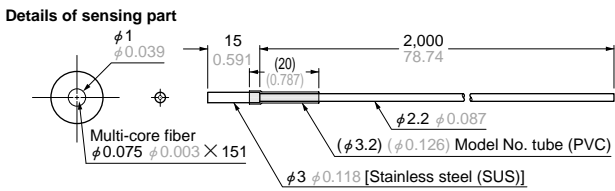

FT-WS8 Free-cut **With FX-AT3**

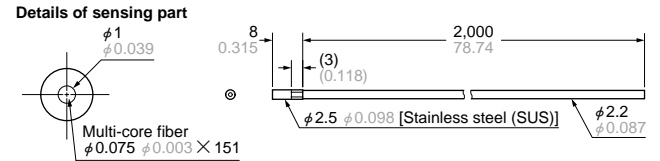

FT-W4 Free-cut **With FX-AT3**

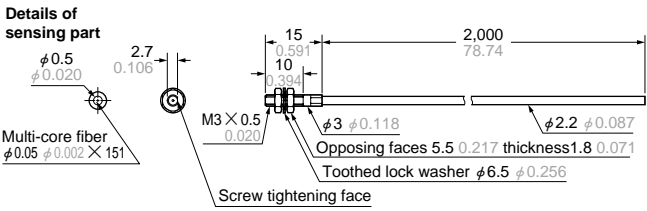

FT-WS4 Free-cut **With FX-AT4**

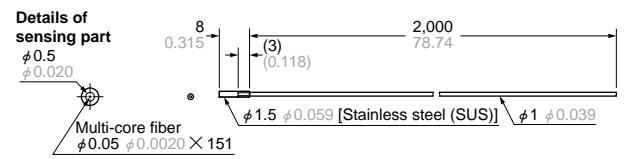

FT-WV42 Free-cut **With FX-AT4**

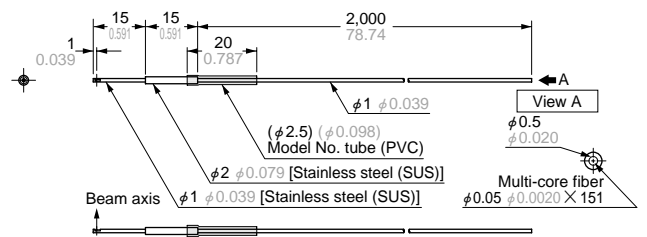

FT-Z8H Free-cut **With FX-AT5**

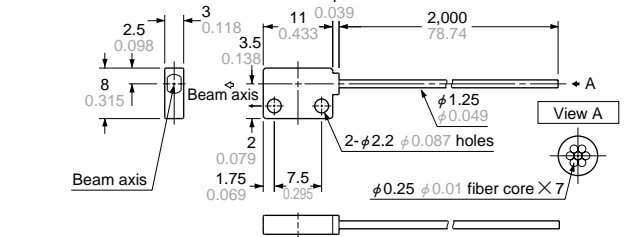

FT-Z8E Free-cut **With FX-AT5**

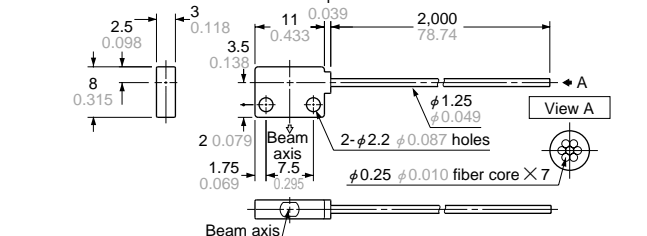

FT-Z8 Free-cut **With FX-AT5**

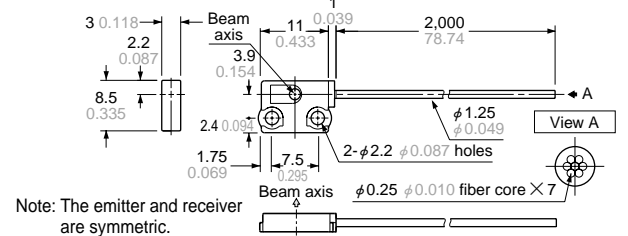

Note: The emitter and receiver are symmetric.

FT-P80 Free-cut

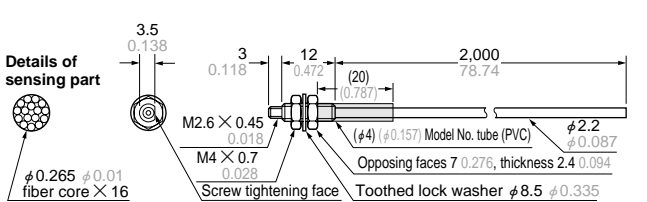

FT-P60 Free-cut **With FX-AT5**

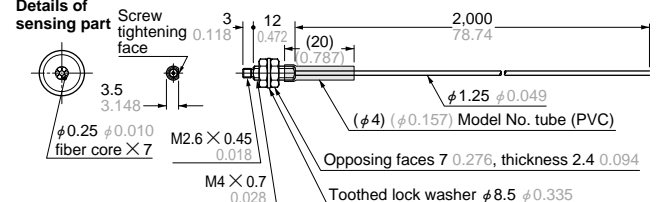

FIBER SENSORS
 Fiber Selection
FX-301
 Digital Setting
 FX-302
 Bank Selection Unit
 FX-303
 FX-CH
 Manually Set
 FX-311
 Analog Output
 FX-11A
 Color Detection
 FZ-10

FX-301

DIMENSIONS (Unit: mm in) The CAD data in the dimensions can be downloaded from the SUNX fiber sensor website: <http://www.fiber-sensor.com/>

Thru-beam type fibers 

FT-P40

Free-cut

With FX-AT4

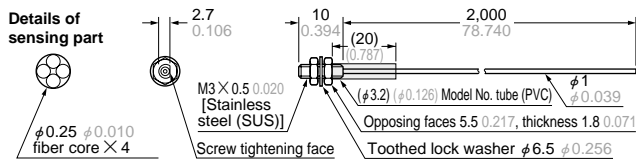

FT-P2

With FX-AT2

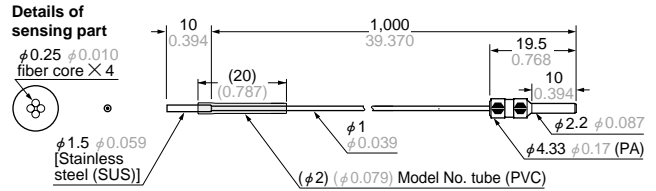

FT-PS1

With FX-AT2

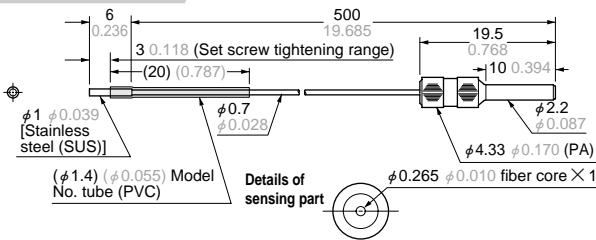

FT-A30

Free-cut

With FX-AT3

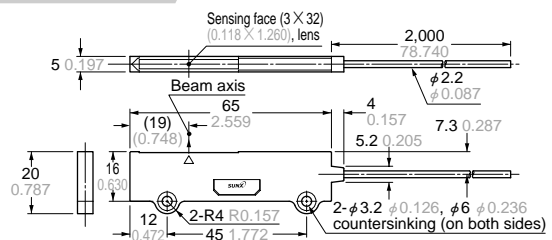

FT-A8

Free-cut

With FX-AT3

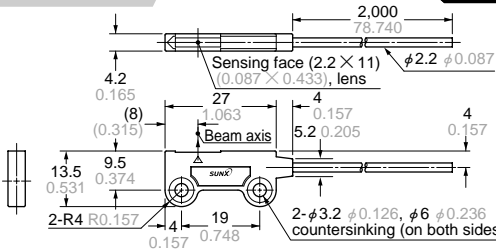

FT-AFM2

Free-cut

With FX-AT3

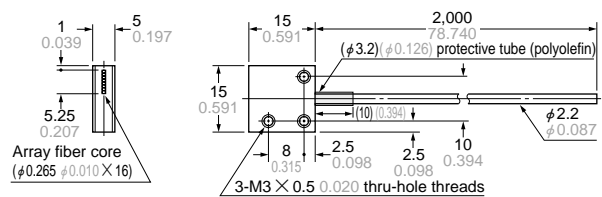

FT-AFM2E

Free-cut

With FX-AT3

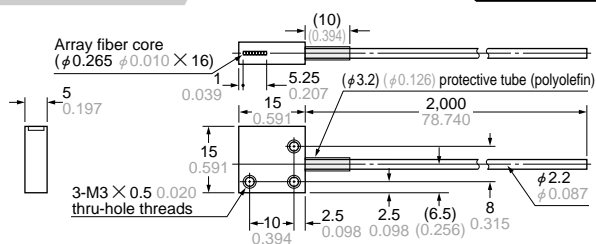

FT-K8

Free-cut

With FX-AT3

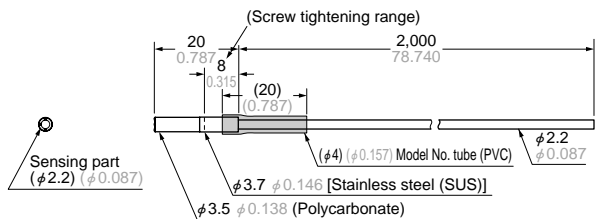

FT-KV8

Free-cut

With FX-AT3

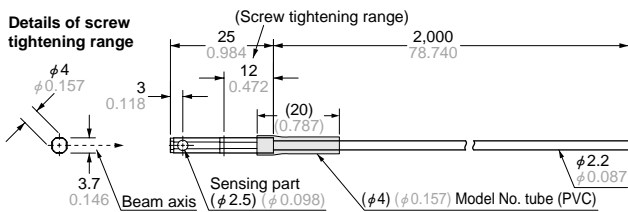

FT-KV1

Free-cut

With FX-AT4

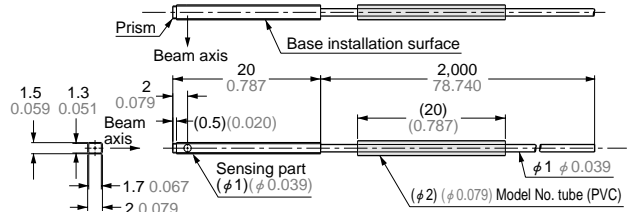

FT-E12

With FX-AT2

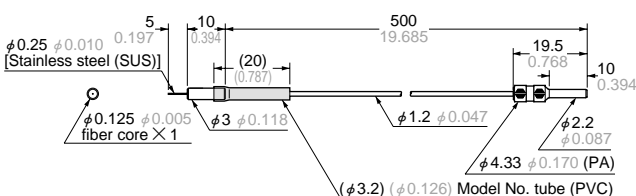

FT-E22

With FX-AT2

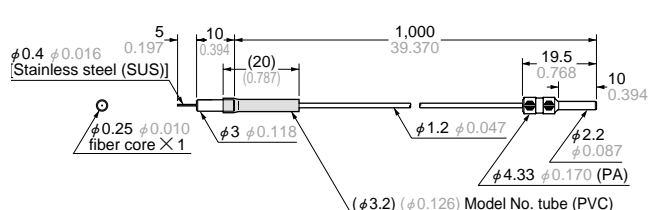

DIMENSIONS (Unit: mm in)

The CAD data in the dimensions can be downloaded from the SUNX fiber sensor website: <http://www.fiber-sensor.com/>

Thru-beam type fibers

FT-P81X

With FX-AT2

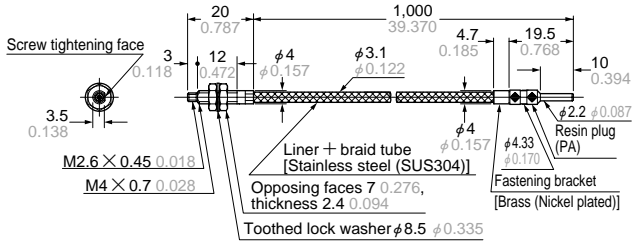

Details of sensing part



FT-H35-M2

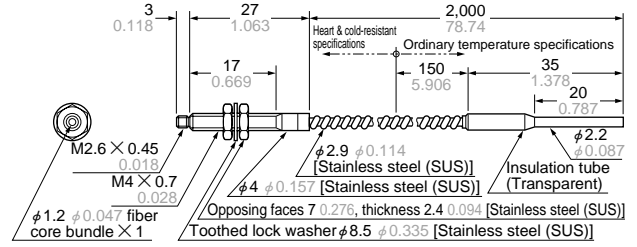

FT-H35-M2S6

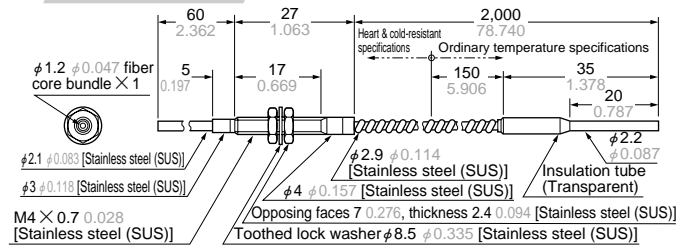

FT-H20W-M1 FT-H20W-M2

With FX-AT2

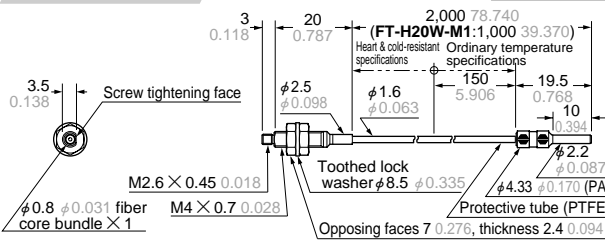

FT-H20-M1

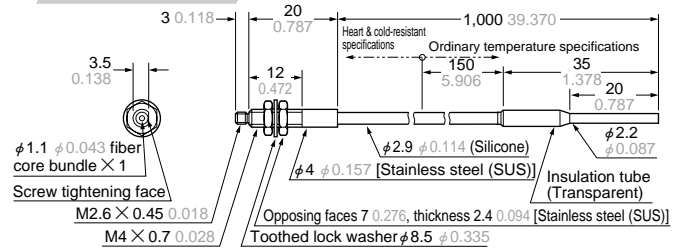

FT-H13-FM2

Free-cut

With FX-AT3

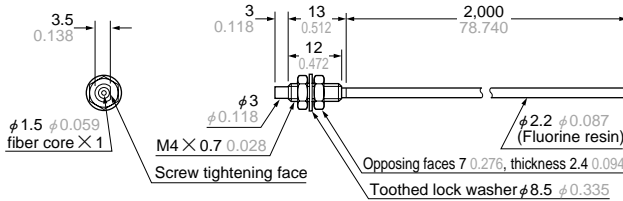

FT-Z802Y

Free-cut

With FX-AT3

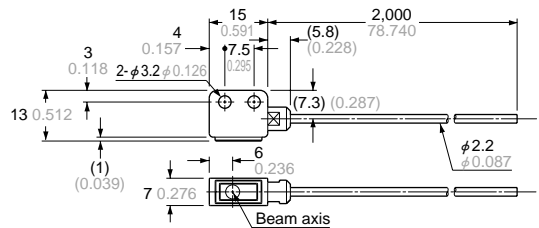

FT-L8Y

Free-cut

With FX-AT3

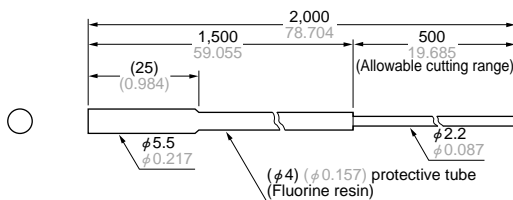

FT-V8Y

Free-cut

With FX-AT3

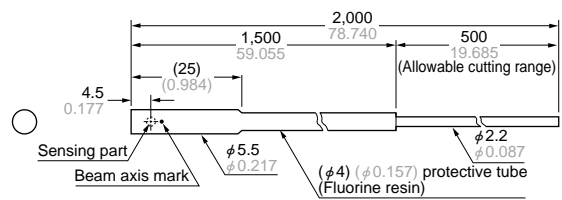

FT-6V

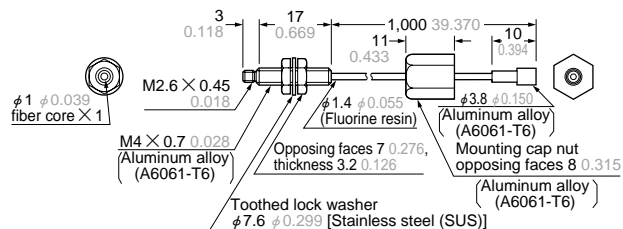

FT-60V

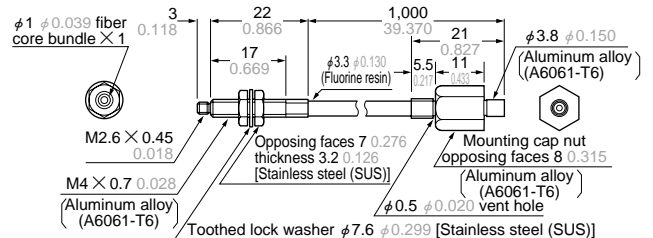

FX-301

DIMENSIONS (Unit: mm in)

The CAD data in the dimensions can be downloaded from the SUNX fiber sensor website: <http://www.fiber-sensor.com/>

Reflective type fibers



FD-B8

Free-cut

With FX-AT3

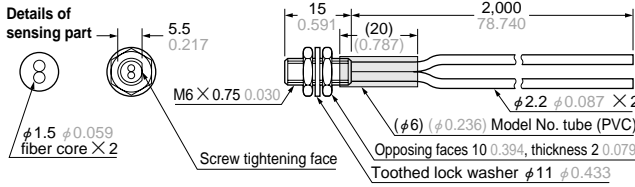

FD-FM2

Free-cut

With FX-AT3

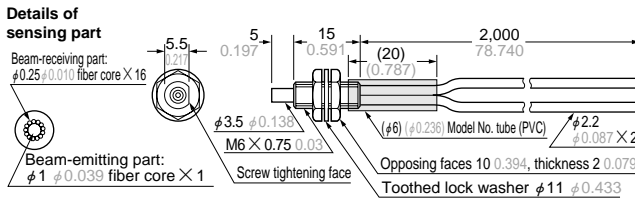

FD-T80

Free-cut

With FX-AT5

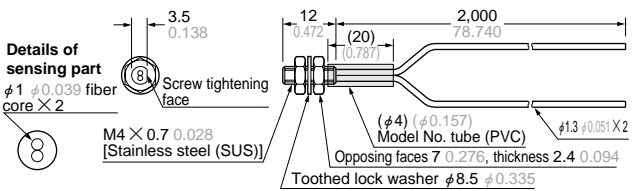

FD-S80

Free-cut

With FX-AT5

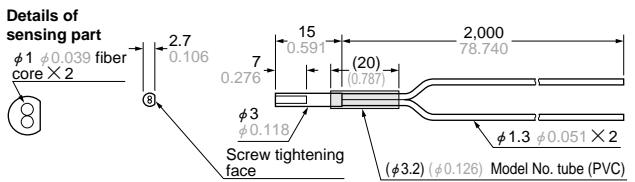

FD-N4

Free-cut

With FX-AT10

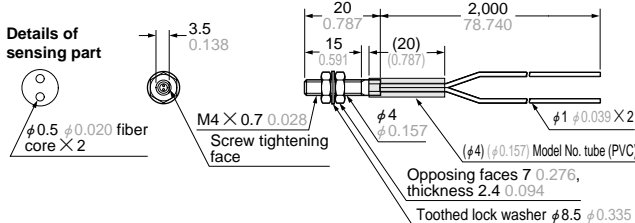

FD-NFM2S FD-NFM2S4

Free-cut

With FX-AT4

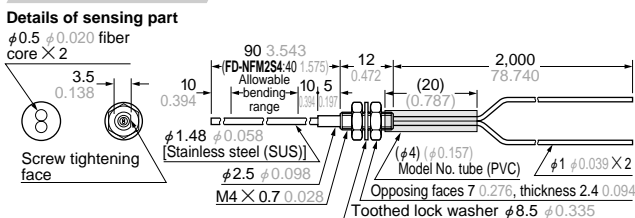

FD-5

With FX-AT2

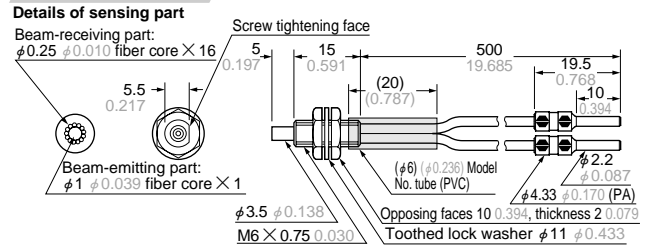

FD-FM2S FD-FM2S4

Free-cut

With FX-AT3

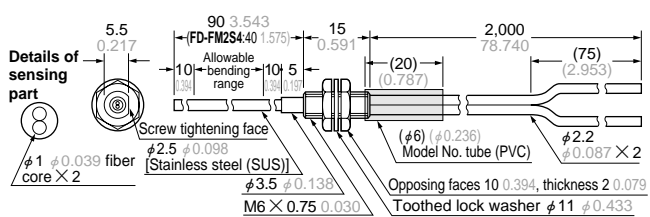

FD-T40

Free-cut

With FX-AT4

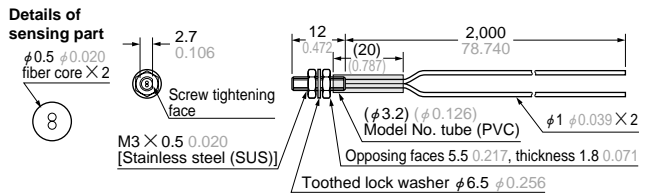

FD-N8

Free-cut

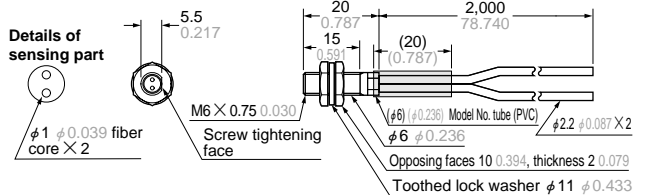

FD-NFM2

Free-cut

With FX-AT4

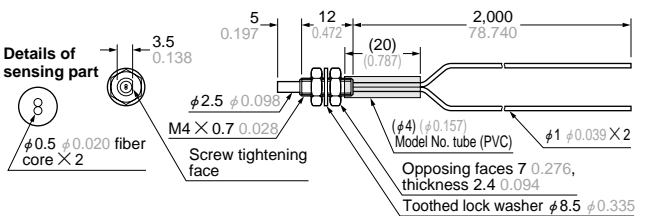

FD-SNFM2

Free-cut

With FX-AT4

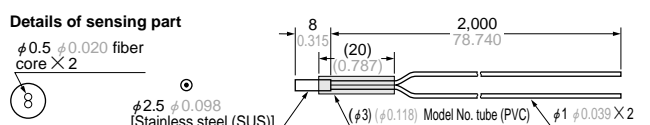

DIMENSIONS (Unit: mm in)

The CAD data in the dimensions can be downloaded from the SUNX fiber sensor website: <http://www.fiber-sensor.com/>

Reflective type fibers



FD-R80

Free-cut

With FX-AT3

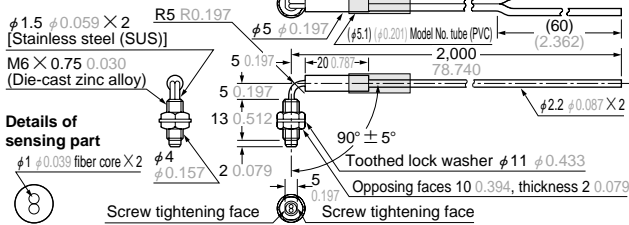

FD-SFM2SV2

Free-cut

With FX-AT3

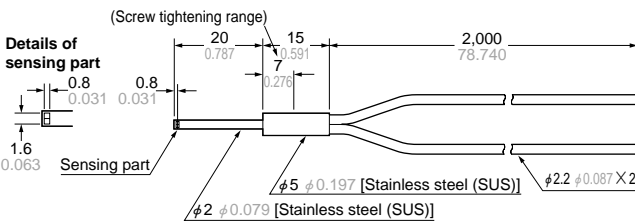

FD-W8

Free-cut

With FX-AT3

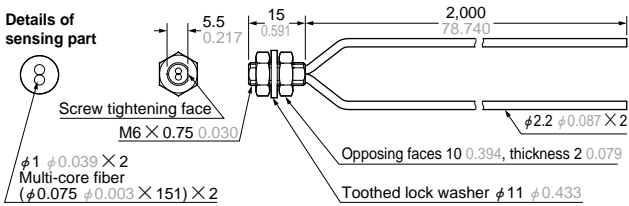

FD-WT8

Free-cut

With FX-AT5

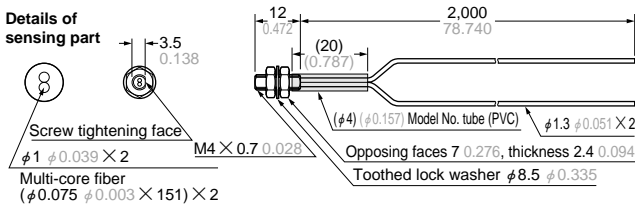

FD-WT4

Free-cut

With FX-AT4

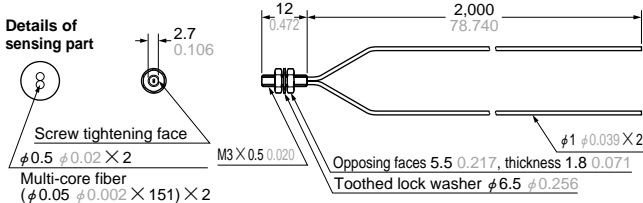

FD-WSG4

Free-cut

With FX-AT6

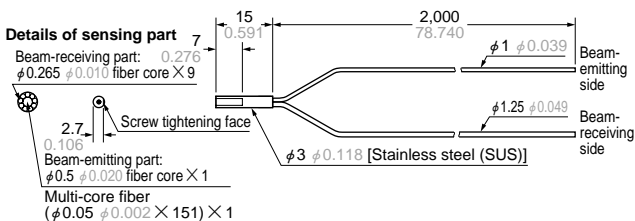

FD-V41

Free-cut

With FX-AT4

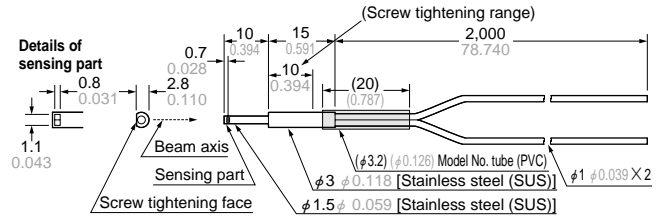

FD-WKZ1

Free-cut

With FX-AT3

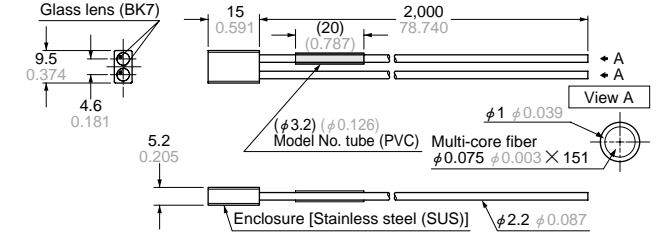

FD-W44

Free-cut

With FX-AT4

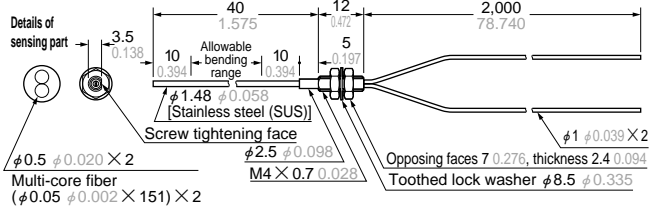

FD-WS8

Free-cut

With FX-AT5

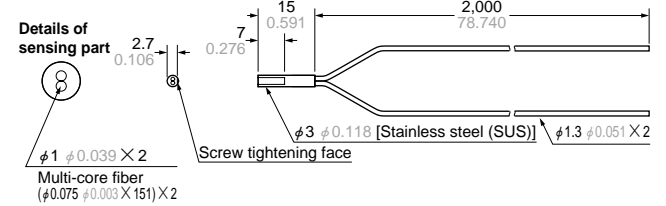

FD-WG4

Free-cut

With FX-AT6

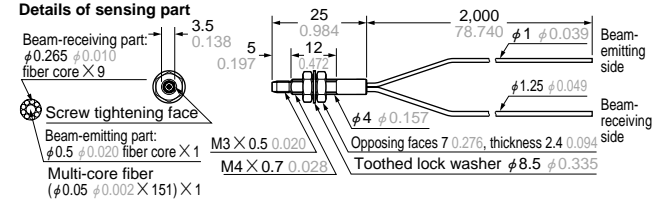

FD-WL41

Free-cut

With FX-AT4

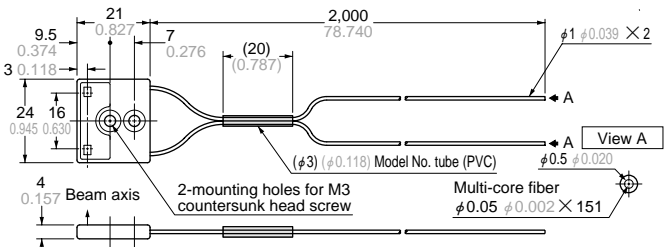

FX-301

DIMENSIONS (Unit: mm in) The CAD data in the dimensions can be downloaded from the SUNX fiber sensor website: <http://www.fiber-sensor.com/>

Reflective type fibers

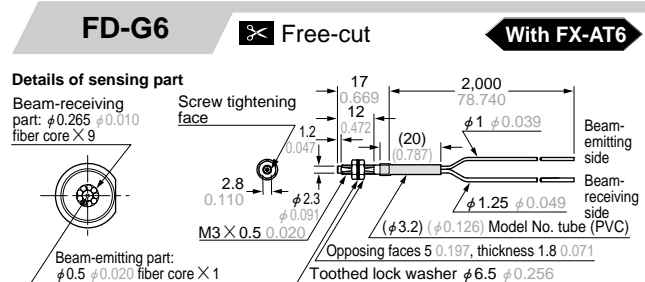
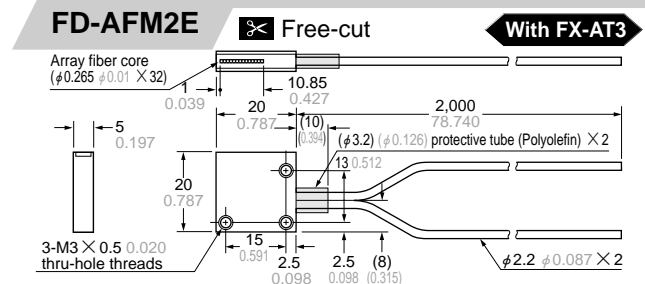
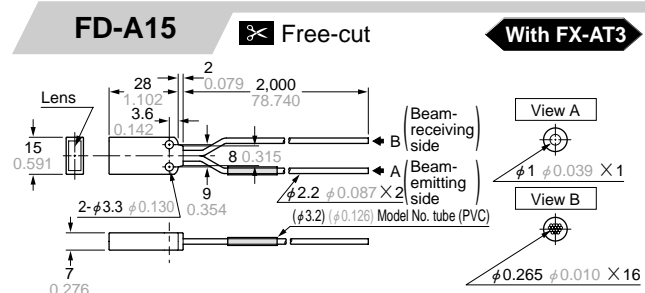
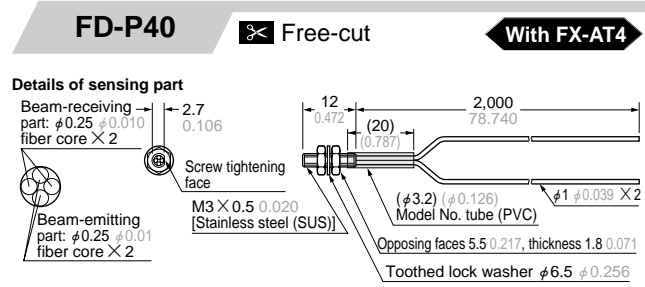
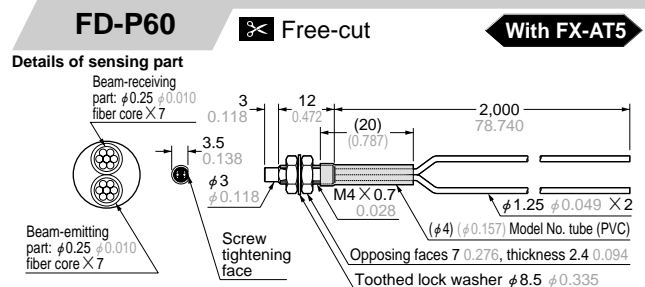
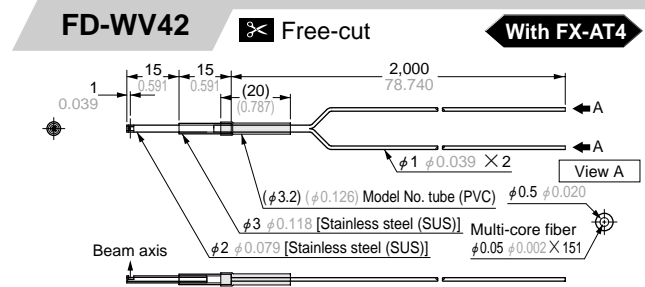
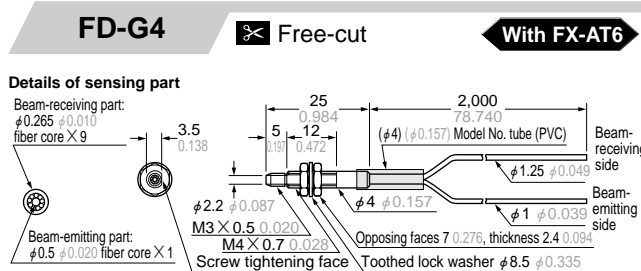
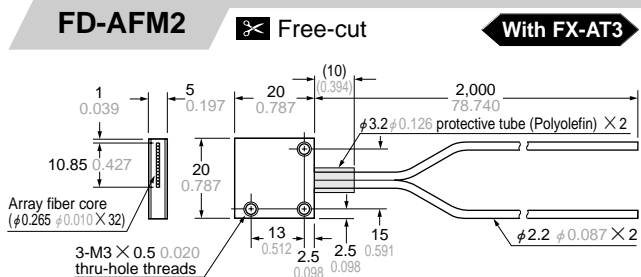
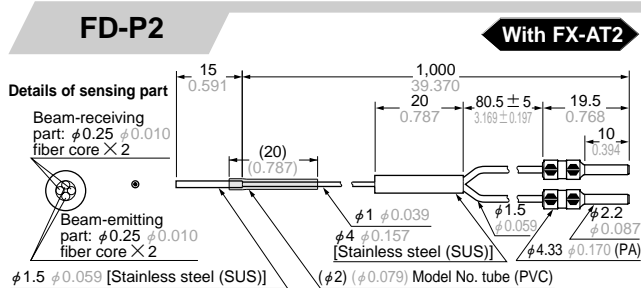
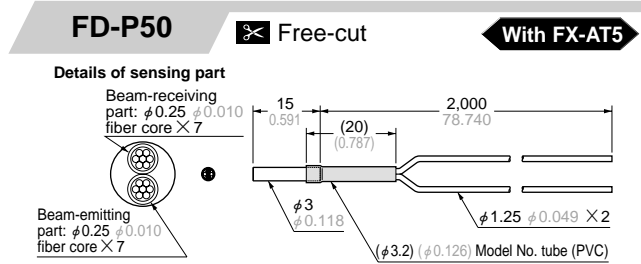
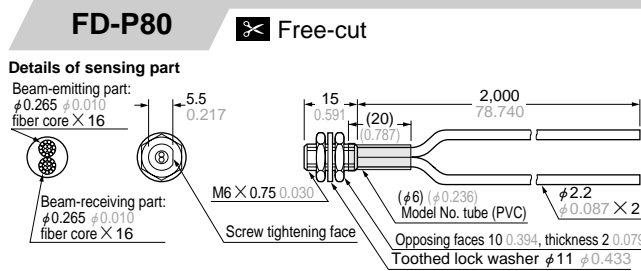
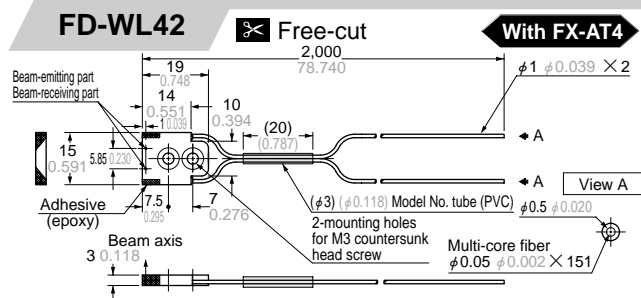

DIMENSIONS (Unit: mm in) The CAD data in the dimensions can be downloaded from the SUNX fiber sensor website: <http://www.fiber-sensor.com/>

Reflective type fibers

FD-EG1

With FX-AT2

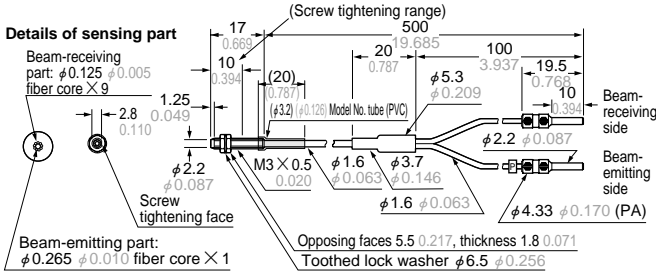

FD-EG2

With FX-AT2

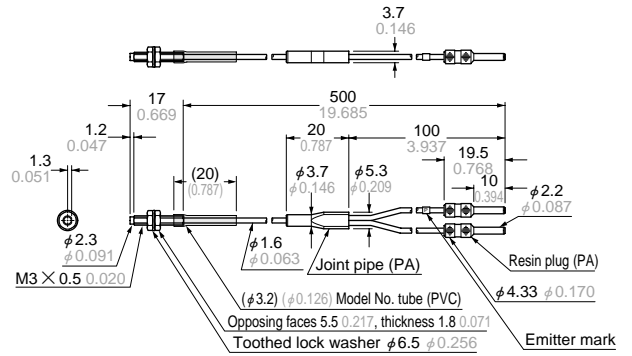

FD-E12

With FX-AT2

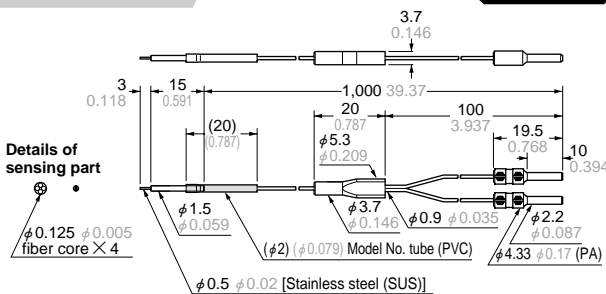

Details of sensing part

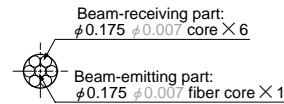

FD-E22

With FX-AT2

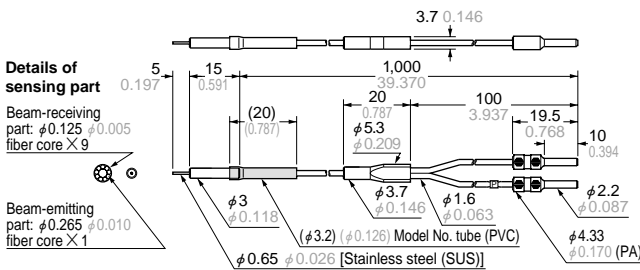

FD-EG3

With FX-AT2

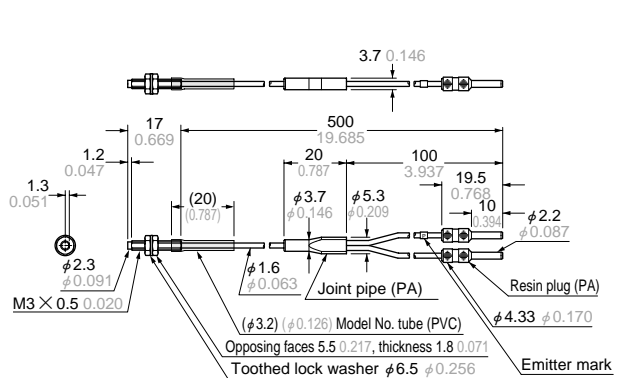

Details of sensing part

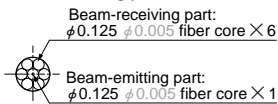

FD-EN500S1

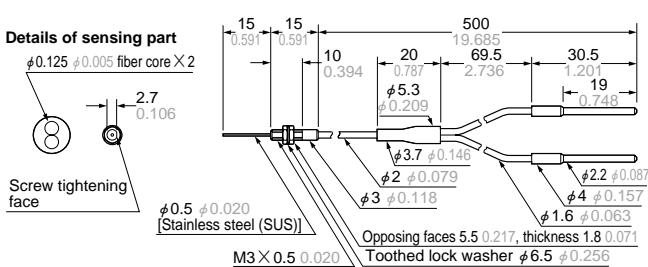

FD-ENM1S1

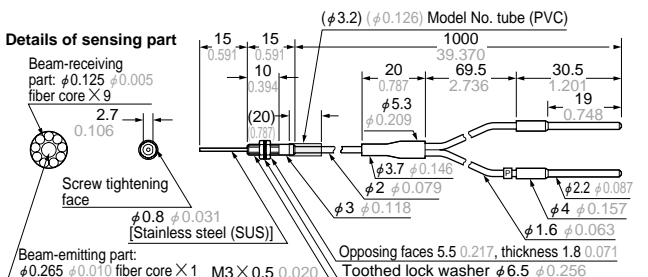

FD-L43

Free-cut

With FX-AT5

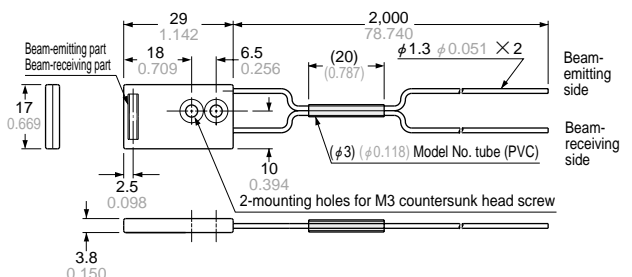

FX-301

DIMENSIONS (Unit: mm in) The CAD data in the dimensions can be downloaded from the SUNX fiber sensor website: <http://www.fiber-sensor.com/>

Reflective type fibers 

FD-L41

✂ Free-cut

With FX-AT4

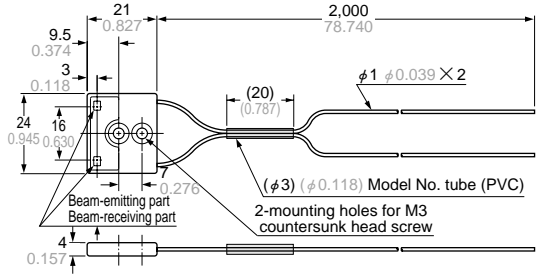

FD-L42

✂ Free-cut

With FX-AT4

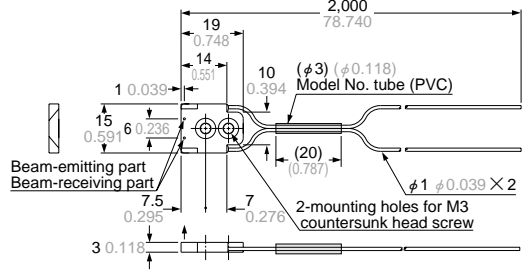

FD-L4

✂ Free-cut

With FX-AT4

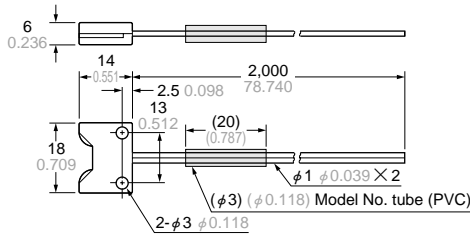

**FD-F41 FD-F91
FD-F4 FD-F9**

✂ Free-cut

With FX-AT4

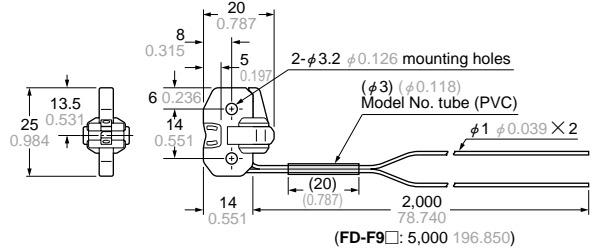

FD-F8Y

✂ Free-cut

With FX-AT3

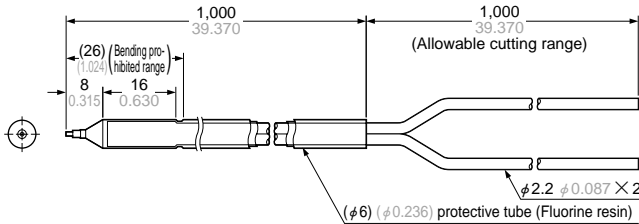

FD-P81X

With FX-AT2

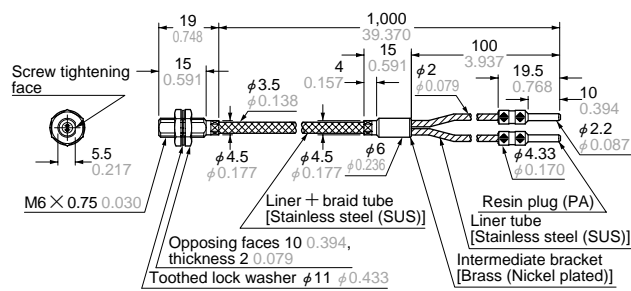

Details of sensing part

Beam-emitting part: $\phi 0.25 \phi 0.010$ fiber core $\times 9$
Beam-receiving part: $\phi 0.25 \phi 0.010$ fiber core $\times 9$

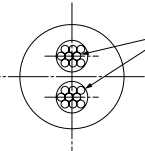

FD-G6X

✂ Free-cut

With FX-AT6

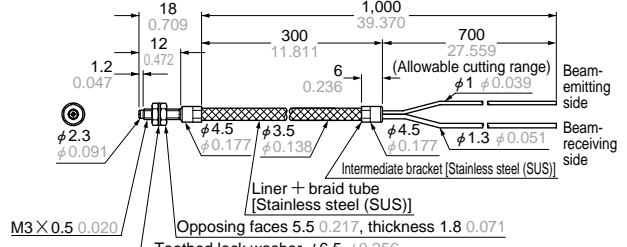

Details of sensing part

Beam-receiving part: $\phi 0.25 \phi 0.010$ fiber core $\times 9$

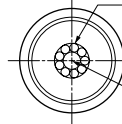

Beam-emitting part: $\phi 0.5 \phi 0.020$ fiber core $\times 1$

DIMENSIONS (Unit: mm in)

The CAD data in the dimensions can be downloaded from the SUNX fiber sensor website: <http://www.fiber-sensor.com/>

Reflective type fibers

FD-H35-M2

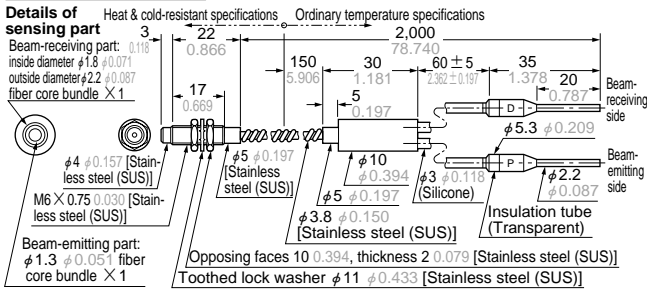

FD-H35-M2S6

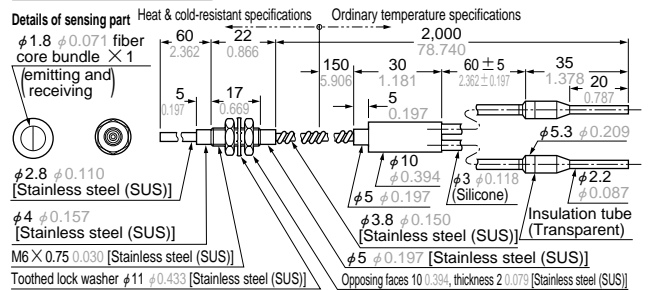

FD-H20-M1

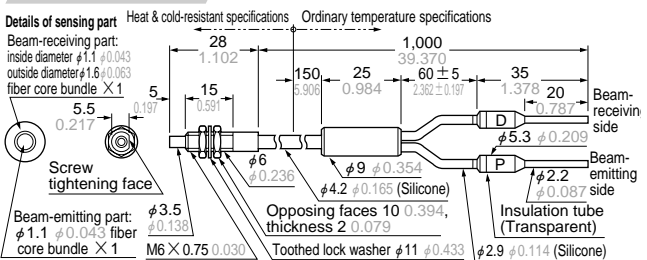

FD-H30-L32

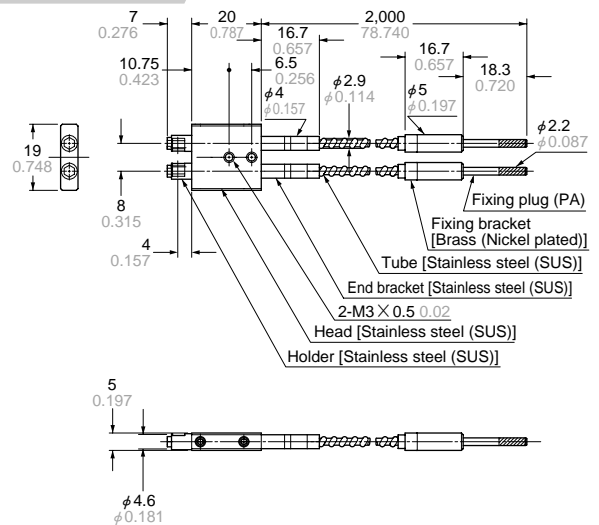

FD-H20-21

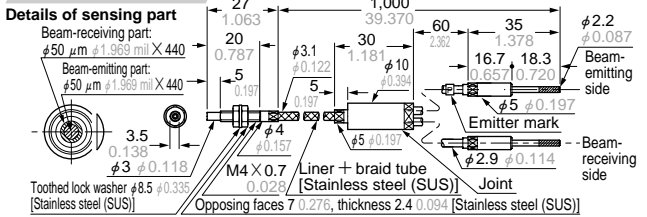

FD-H18-L31

Free-cut

With FX-AT3

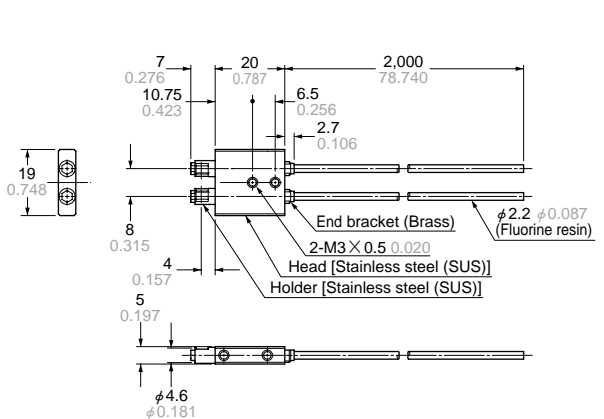

FD-H35-20S

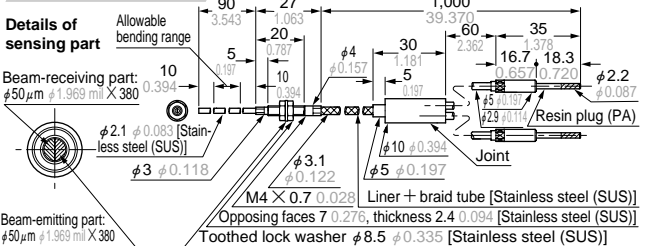

FD-H13-FM2

Free-cut

With FX-AT3

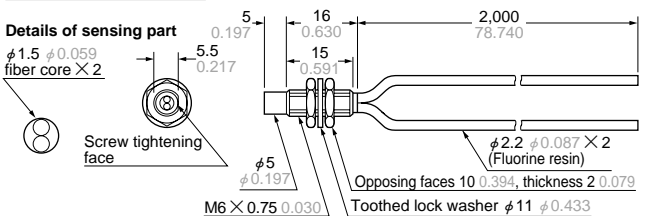

FD-6V

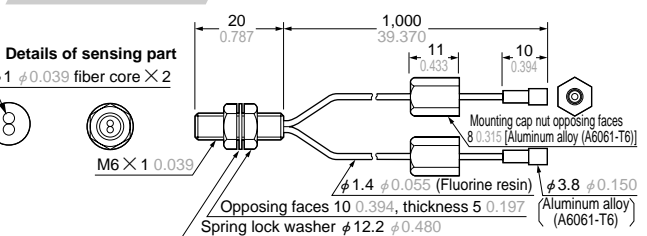

FX-LE1

Expansion lens (Optional)

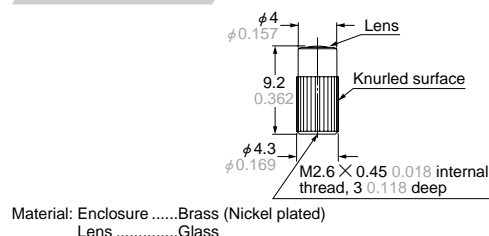

FX-301

DIMENSIONS (Unit: mm in) The CAD data in the dimensions can be downloaded from the SUNX fiber sensor website: <http://www.fiber-sensor.com/>

FX-LE2 Super-expansion lens (Optional)

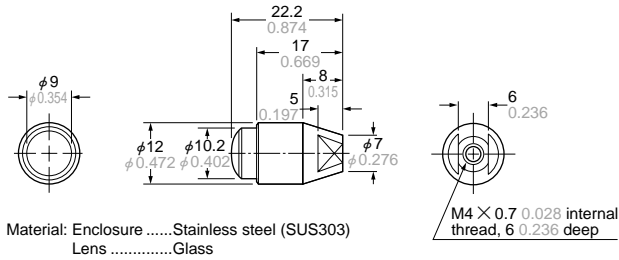

FX-SV1 Side-view lens (Optional)

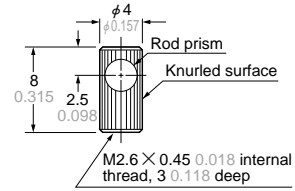

FV-LE1 Expansion lens (For vacuum type fiber · Optional)

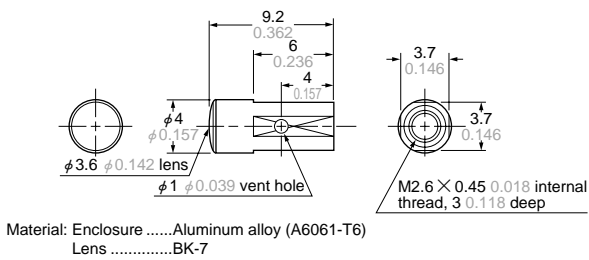

FV-BR1 Photo-terminal (For vacuum type fiber · Optional)

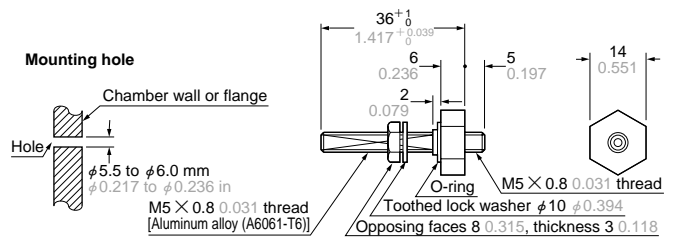

FT-J6 Fiber at atmospheric side (For vacuum type fiber · Optional)

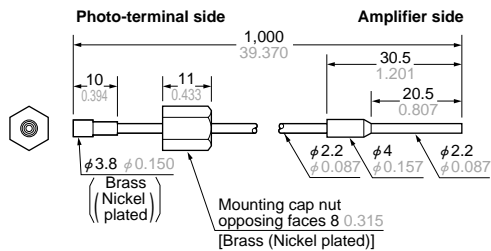

FX-MR1 Pinpoint spot lens (Optional)

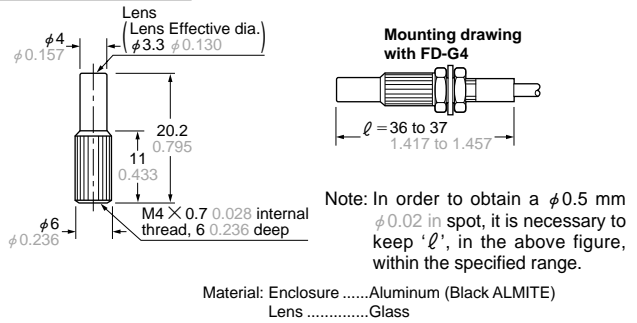

FX-MR2 Zoom lens (Optional)

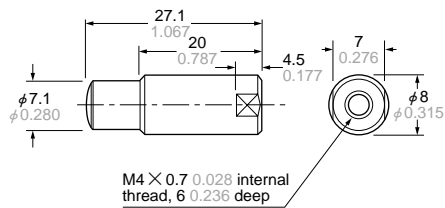

FX-MR3 Finest spot lens (Optional)

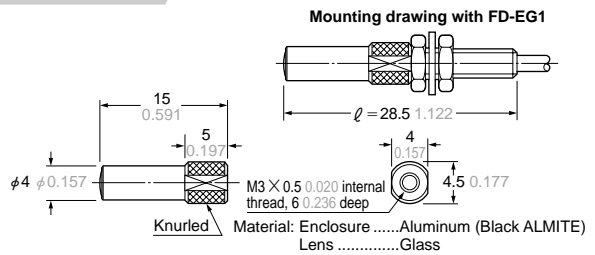

Notes: 1) In order to obtain a $\phi 0.3$ mm $\phi 0.012$ in spot, it is necessary for ' ℓ ', in the above figure, to be 28.5 mm 1.122 in.
2) When inserting the fiber, insert it fully till it stops.

FX-MR5 Zoom lens (Optional)

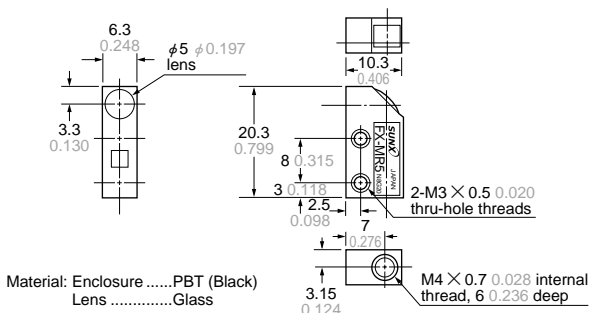

NT-FX-MR5 (exclusive nut) is attached.

FX-MR6 Finest spot lens (Optional)

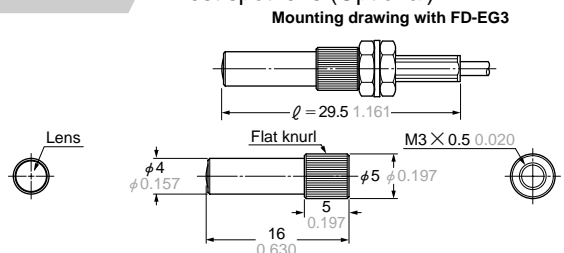

Notes: 1) In order to obtain a $\phi 0.1$ mm $\phi 0.004$ in spot, it is necessary for ' ℓ ', in the above figure, to be 29.5 mm 1.161 in.
2) When inserting the fiber, insert it fully till it stops.

DIMENSIONS (Unit: mm in) The CAD data in the dimensions can be downloaded from the SUNX fiber sensor website: <http://www.fiber-sensor.com/>

MS-EX-3 Mounting bracket for FX-MR2 (Accessory for FX-MR2)

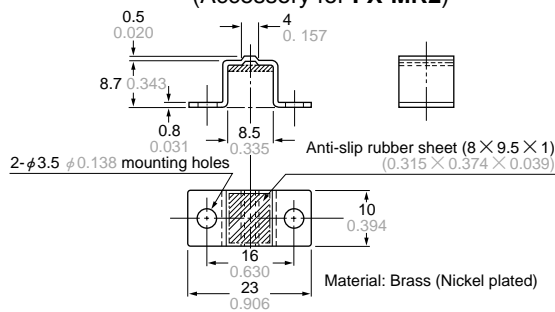

Mounting bracket for FD-WKZ1 (Accessory for FD-WKZ1)

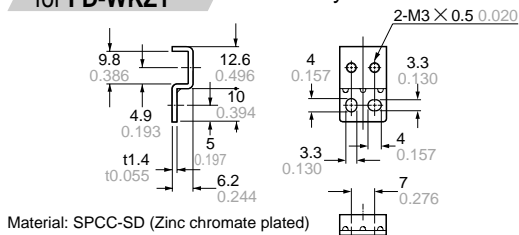

FB-1 Fiber bender (Optional)

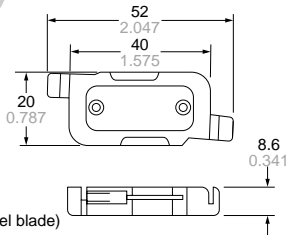

FX-CT2 Fiber cutter (Accessory for free-cut type fiber)

FX-CT2 is not attached with the FT-NB8/N8/P80 or the FD-N8/N4/P80

A conventional FX-CT1 fiber cutter is attached with the FT-P80 and the FD-P80.

Material: ABS

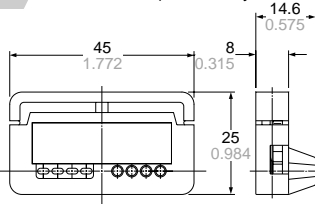

FX-AT3 Attachment for φ2.2 mm φ0.087 in fiber (Accessory)

FX-AT3 is not attached with the FT-NB8/N8/P80, FD-N8/P80

Material: Polycarbonate

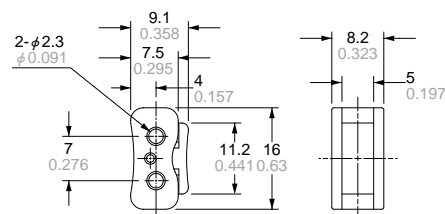

FX-AT5 Attachment for φ1.3 mm φ0.051 in fiber (Accessory for φ1.3 mm φ0.051 in fiber)

Materials: Holder.....PA (Nylon66)
GroundPOM

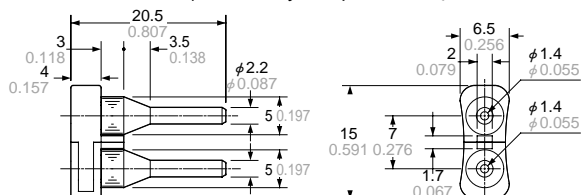

FTP-□ FDP-□ Protective tube (Optional)

FTP-□, FDP-N□

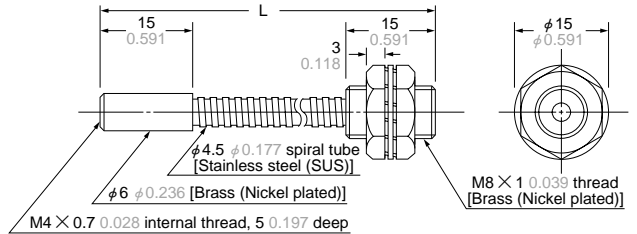

FTP-N□

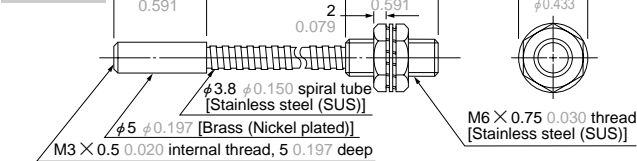

FDP-N□

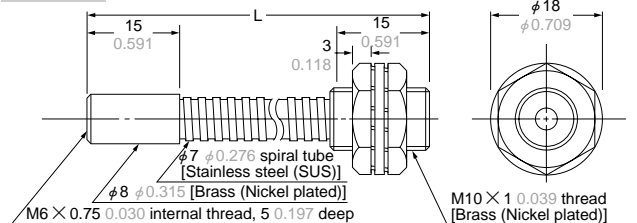

Model No.	Length L (mm in)
FTP-500, FTP-N500, FDP-N500, FDP-500	500 +10 19.685 + 0.394 0
FTP-1000, FTP-N1000, FDP-N1000, FDP-1000	1,000 +10 39.37 + 0.394 0
FTP-1500, FTP-N1500, FDP-N1500, FDP-1500	1,500 +10 59.055 + 0.394 0

FX-AT2 Attachment for fixed-length fiber (Accessory for fixed-length fiber)

Material: POM

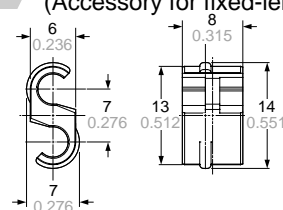

FX-AT4 Attachment for φ1 mm φ0.039 in fiber (Accessory for φ1 mm φ0.039 in fiber)

FX-AT4 is not attached with the FD-N4

Materials: Holder.....PA (Nylon66)
GroundPOM

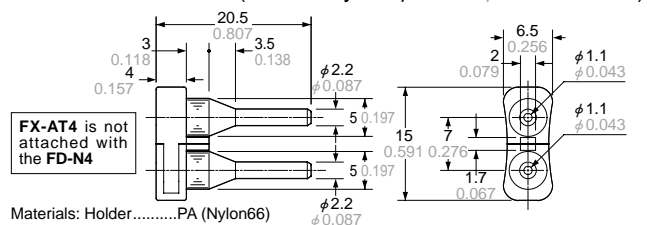

FX-AT6 Attachment for φ1 mm / φ1.3 mm φ0.039 in / φ0.051 in mixed fiber (Accessory for φ1 mm / φ1.3 mm φ0.039 in / φ0.051 in fiber)

Materials: Holder.....PA (Nylon66)
GroundPOM

