

# DP4 SERIES

**New**

## Compact Size Digital Pressure Sensor



**New shape makes it most suitable for panel mounting**

\* Passed the UL 991 Environment Test



\* UL 61010C-1 compatible, Passed the UL 991 Environment Test based on SEMI S2-0200.  
[Category applicable for semiconductor manufacturing: TWW2, Process Equipment]  
[Applicable standards: UL 61010C-1]  
[Additional test / evaluation standards as per intended use: UL991, SEMI S2-0200]

### Light-weight, compact design

A compact form specifically designed for mounting on an equipment panel. It only uses half the space of our conventional product and provides the lightest weight in the industry of just 30 g (cables excluded).

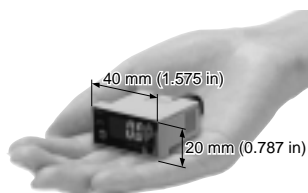

### Can be mounted closely

Even when you use more than one sensor at the same time, you can mount them close together in one hole to save both space and man-hours.

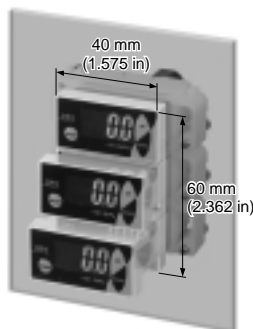

### Bright, easy to view two-color digital display

The digital display is a large, easy-to-view, and two-color digital display. It is also functions as an output indicator as it changes from green to red color when the output turns ON, enabling you confirm the output status at a glance.

Output OFF (Green)



Output ON (Red)



### Usable with a panel thickness of 1 to 6 mm 0.039 to 0.236 in

Since the panel thickness can be from 1 to 6 mm 0.039 to 0.236 in, the sensor can even be mounted on thick, resin-made panels.

### Two types of sensor mounting brackets available

The **MS-DP-3** bracket, enabling vertical mounting, and the **MS-DP-4**, enabling horizontal mounting, are available as options. One-touch mounting of the sensor mounting brackets is possible with the panel mounting bracket included with the sensor.

• MS-DP-3

• MS-DP-4

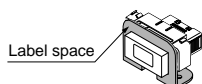

### Supplied with a simple-to-mount panel mounting bracket

A panel mounting bracket **MS-DP-1** is enclosed to enable simple mounting of the sensor onto the panel surface, thus contributing to the total cost reduction.

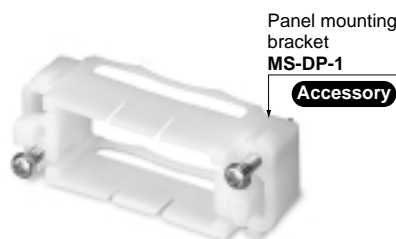

※The panel mounting bracket **MS-DP-5** (optional) enabling the sensors to be attached to each other laterally is available.

### Snap-fit connector is used for cable connection

The cable has a snap-fit connector for easy mounting and removal. The connector can be easily assembled by yourself.

Further, the connection by connector eliminates waste and is eco-friendly.

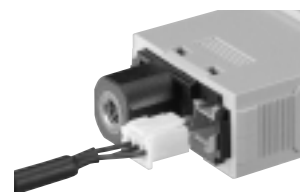

※Connector attached cable **CN-63-C2** (2 m 6.562 ft cable length) and **CN-63-C5** (5 m 16.404 ft cable length) are also available.

## APPLICATIONS

### Checking IC absorption

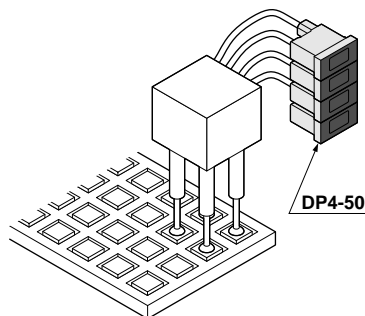

### Checking degree of vacuum for vacuum molding

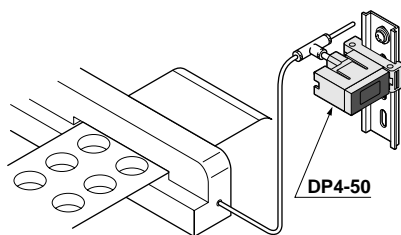

### Checking reference pressure of device

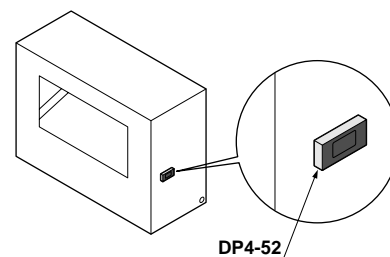

## Can be mounted on a DIN rail

The sensor can be mounted even on a 35 mm 1.378 in width DIN rail by using the optional DIN rail mounting bracket (**MS-DP-2**). It can be mounted in a narrow space inside of your device.



Mountable from four different directions

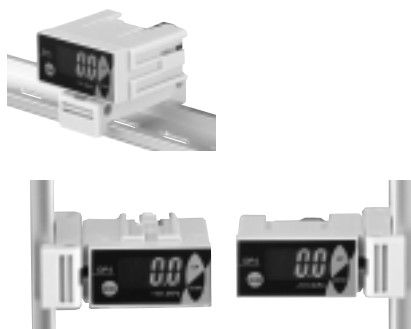

## High speed response of 2 ms or less

The sensor has a high speed response of 2 ms or less.

In addition, the sensor has a chattering prevention function. This allows change-over of the response time so that fluctuation of the reference pressure generated during operation of the large-diameter cylinder and the ejector is not detected as an abnormal pressure.

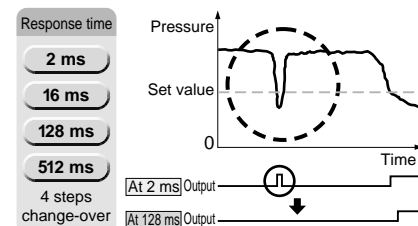

## Change-over to analog bar display possible

The pressure changes can be indicated as a bar display. The analog bar color reflects the changes in the output. (The detected pressure value is displayed in steps of 14 % F.S. approx.)

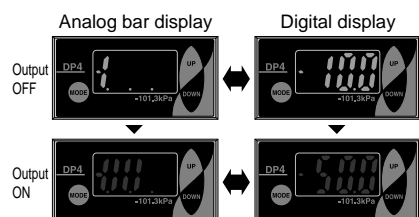

## ± 100 kPa compound pressure type available

To serve a broad range of pressure needs, we offer ± 100.0 kPa, compound pressure type, in addition to the 0 to 101.3 kPa and 0 to 1.000 MPa types.

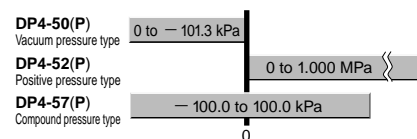

## Selection from six pressure units

The pressure unit can be selected from six different systems to suit your requirement. (The selectable pressure units differ with the sensor type. When the pressure unit is changed, the measured pressure value and the set values are automatically converted.)

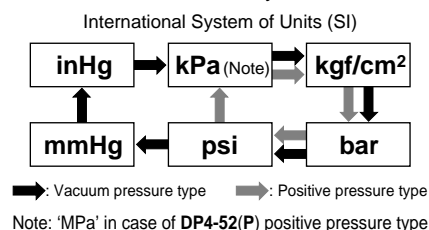

## Incorporated with the memory bank function

You can store two patterns of set values. Hence, the setup can be changed by a single touch.

## Flexible control with four output modes

### 1 Hysteresis mode

The hysteresis of the output can be set, as desired, with the set values.

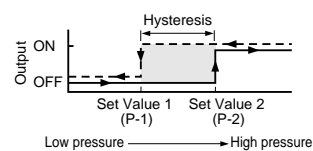

Note: The above figure is for the case when the output operation is set to NO (normally open).

### 2 Window comparator mode

The output can be turned ON or OFF by a pressure within the set range.

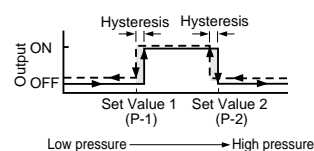

Note: The above figure is for the case when the output operation is set to NO (normally open).

### 3 Automatic sensitivity setting mode

Using actual objects, if the pressure values for OK objects and NG objects are input, then the sensor automatically set to the optimum pressure value (mid-value).

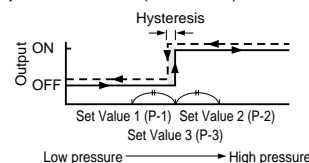

Note: The above figure is for the case when the output operation is set to NO (normally open).

### 4 Forced output mode

The output is forcibly maintained in the OFF state in the sensing mode, irrespective of the set values.

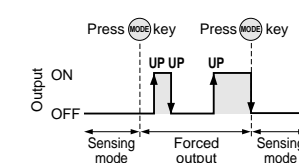

Note: The above figure is for the case when the output operation is set to NO (normally open).

## ORDER GUIDE

Type	Appearance	Rated pressure range (Note)	Model No.	Pressure port	Output
Vacuum pressure -101 kPa type		0 to -101.3 kPa	DP4-50	M5 female thread	NPN open-collector transistor
			DP4-50P		PNP open-collector transistor
Positive pressure 1 MPa type		0 to 1.000 MPa	DP4-52		NPN open-collector transistor
			DP4-52P		PNP open-collector transistor
Compound pressure ±100 kPa type		-100.0 to 100.0 kPa	DP4-57		NPN open-collector transistor
			DP4-57P		PNP open-collector transistor

Note: The rated pressure range indicates the range for full product performance.

### Accessory

- MS-DP-1 (Panel mounting bracket)

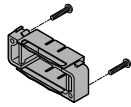

## OPTIONS

Designation	Model No.	Description	
Connector	<b>CN-63</b>	Set of 10 housings and 30 connector pins	
Connector attached cable	<b>CN-63-C2</b>	Length: 2 m 6.562 ft	0.2 mm <sup>2</sup> 3-core cabtyre cable with connector Cable outer diameter: $\phi$ 3.8 mm $\phi$ 0.150 in
	<b>CN-63-C5</b>	Length: 5 m 16.404 ft	
DIN rail mounting bracket	<b>MS-DP-2</b>	For installation to 35 mm 1.378 in width DIN rail	
Sensor mounting bracket	<b>MS-DP-3</b>	Vertical mounting bracket	
	<b>MS-DP-4</b>	Horizontal mounting bracket	
Horizontal multiple panel mounting bracket	<b>MS-DP-5</b>	Enables the sensors to be attached to each other laterally and mounted on the panel.	

### Connector • CN-63

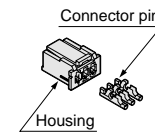

### Connector attached cable • CN-63-C2 • CN-63-C5

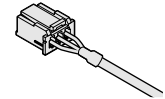

### DIN rail mounting bracket • MS-DP-2

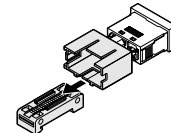

### Horizontal multiple panel mounting bracket

- MS-DP-5

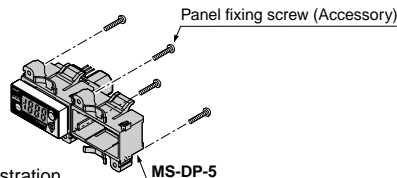

※ The above illustration shows two units connected in sequence.

### Sensor mounting bracket

- MS-DP-3

- MS-DP-4

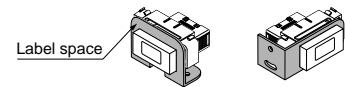

Designed with a 9 mm 0.354 in label space to enable the labeling of the sensors with a label printer (9 mm 0.354 in width) for sensor number and application data.

## SPECIFICATIONS

Item	Type Model No.	Vacuum pressure		Positive pressure		Compound pressure	
		- 101 kPa type		1 MPa type		± 100 kPa type	
		NPN output <b>DP4-50</b>	PNP output <b>DP4-50P</b>	NPN output <b>DP4-52</b>	PNP output <b>DP4-52P</b>	NPN output <b>DP4-57</b>	PNP output <b>DP4-57P</b>
Type of pressure		Gauge pressure					
Rated pressure range		0 to - 101.3 kPa		0 to 1.000 MPa		- 100.0 to 100.0 kPa	
Set pressure range		5.1 to - 101.3 kPa { 0.052 to - 1.033 kgf/cm <sup>2</sup> , 0.051 to - 1.013 bar 0.74 to - 14.70 psi, 38 to - 760 mmHg 1.5 to - 29.9 inHg }		- 0.050 to 1.050 MPa { - 0.51 to 10.71 kgf/cm <sup>2</sup> - 0.50 to 10.50 bar - 7.2 to 152.2 psi }		- 101.3 to 105.0 kPa { - 1.033 to 1.071 kgf/cm <sup>2</sup> - 1.013 to 1.050 bar - 14.68 to 15.22 psi }	
Pressure withstandability		490 kPa		1.470 MPa		490 kPa	
Applicable fluid		Non-corrosive gas					
Hysteresis		1 digit (however, variable in hysteresis mode)					
Repeatability		Within ± 0.2 % F.S. ± 1 digit (within ± 3 digits)				Within ± 0.2 % F.S. ± 2 digits (within ± 6 digits)	
Supply voltage		12 to 24 V DC $\pm \frac{10}{15}$ % Ripple P-P 10 % or less					
Current consumption		40 mA or less					
Output		<NPN output type> NPN open-collector transistor • Maximum sink current: 100 mA • Applied voltage: 30 V DC or less (between output and 0 V) • Residual voltage: 1 V or less (at 100 mA sink current) 0.4 V or less (at 16 mA sink current)			<PNP output type> PNP open-collector transistor • Maximum source current: 100 mA • Applied voltage: Same as supply voltage (between output and +V) • Residual voltage: 2 V or less (at 100 mA source current)		
	Utilization category	DC-12 or DC-13					
	Output operation	NO / NC (selectable by key operation)					
	Output modes	Equipped with 4 types of modes: Hysteresis mode, window comparator mode, automatic sensitivity setting mode, forced output mode (selectable by key operation)					
	Short-circuit protection	Incorporated					
Response time		2 ms, 16 ms, 128 ms, 512 ms or less (selectable by key operation)					
Display		3 1/2 digit LCD display (with red and green backlight) (Sampling rate: 256 ms, 512 ms, 1,024 ms selectable by key operation)					
	Displayable pressure range	5.1 to - 101.3 kPa { 0.052 to - 1.033 kgf/cm <sup>2</sup> , 0.051 to - 1.013 bar 0.74 to - 14.70 psi, 38 to - 760 mmHg 1.5 to - 29.9 inHg }		- 0.050 to 1.050 MPa { - 0.51 to 10.71 kgf/cm <sup>2</sup> - 0.50 to 10.50 bar - 7.2 to 152.2 psi }		- 101.3 to 105.0 kPa { - 1.033 to 1.071 kgf/cm <sup>2</sup> - 1.013 to 1.050 bar - 14.68 to 15.22 psi }	
Analog bar display		Bar display in steps of 14 % F.S. approx.					
Operation display		LCD segment is red when the output is ON, and green when the output is OFF					
Environmental resistance	Pollution degree	3 (Industrial environment)					
	Protection	IP40 (IEC)					
	Ambient temperature	0 to + 50 °C + 32 to + 122 °F (No dew condensation), Storage: - 10 to + 60 °C + 14 to + 140 °F					
	Ambient humidity	35 to 85 % RH, Storage: 35 to 85 % RH					
	EMC	EN 50081-2, EN 50082-2, EN 61000-6-2					
	Voltage withstandability	1,000 V AC for one min. between all supply terminals connected together and enclosure					
	Insulation resistance	50 MΩ, or more, with 500 V DC megger between all supply terminals connected together and enclosure					
	Vibration resistance	10 to 150 Hz frequency, 0.75 mm 0.030 in amplitude, or 5 G in X, Y and Z directions for two hours each					
Shock resistance	100 m/s <sup>2</sup> acceleration (10 G approx.) in X, Y and Z directions for three times each						
Temperature characteristics		Over ambient temperature range + 10 to + 40 °C + 50 to + 104 °F: within ± 2 % F.S. of detected pressure at + 25 °C + 77 °F Over ambient temperature range 0 to + 50 °C + 32 to + 122 °F: within ± 5 % F.S. of detected pressure at + 25 °C + 77 °F					
Pressure port		M5 female thread					
Material		Front case: ABS, LCD display: PET, Rear case: PBT [M5 threaded part: Brass (nickel plated)]					
Connecting method		Connector					
Suitable cable	Conductor cross-section area (Note)	0.16 to 0.32 mm <sup>2</sup> (AWG#25 to 22)					
	Lead wire diameter	φ 1.2 to φ 1.8 mm φ 0.047 to φ 0.071 in					
	Wire material	Tin plated, soft, twisted copper wire					
Cable extension		Extension up to total 100 m 328.084 ft (less than 10 m 32.808 ft when conforming to CE marking) is possible with 0.3 mm <sup>2</sup> , or more, cable					
Weight		30 g approx.					
Accessories		Panel mounting bracket (MS-DP-1): 1 set, Pressure unit label: 1 pc. Connector: 1 set (Housing: 1 pc., Connector pin: 3 pcs.)					

Note: If the wiring is longer than 5 m 16.404 ft, use a cable with a diameter of 0.3 mm<sup>2</sup> or more.

Head-separated  
DP5/DPH

DP4

Digital Display  
DP2

DP3

DP-M

LED Bar Display  
PE

## I/O CIRCUIT AND WIRING DIAGRAMS

### NPN output type

#### I/O circuit diagram

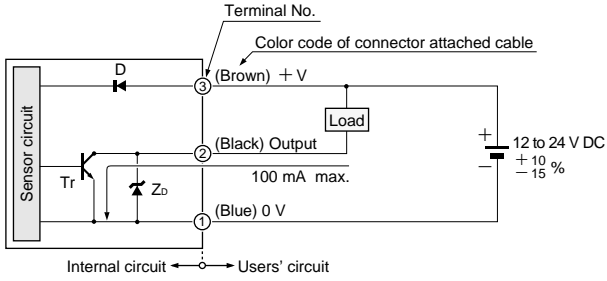

#### Pin position

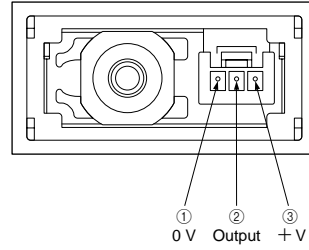

Symbols ... D : Reverse supply polarity protection diode  
 Zb : Surge absorption zener diode  
 Tr : NPN output transistor

### PNP output type

#### I/O circuit diagram

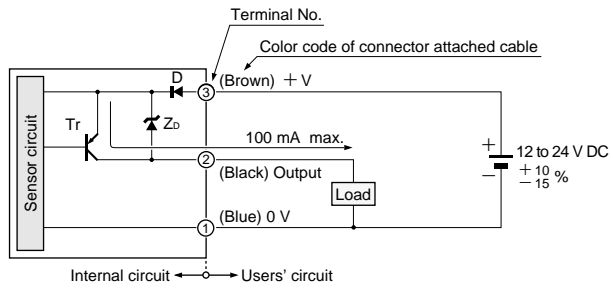

#### Pin position

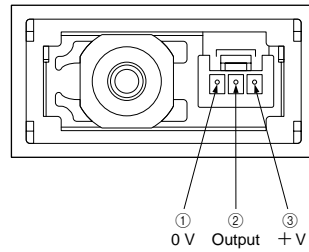

Symbols ... D : Reverse supply polarity protection diode  
 Zb : Surge absorption zener diode  
 Tr : PNP output transistor

## PRECAUTIONS FOR PROPER USE



- This product is not a safety sensor. Its use is not intended or designed to protect life and prevent body injury or property damage from dangerous parts of machinery. It is a normal pressure detection sensor.
- The **DP4** series is designed for use with non-corrosive gas. It cannot be used with liquid or corrosive gas.

### Operation

- If setting is impossible even with pressing the MODE key, verify whether the key-protect function is enabled. Please note that pressing down on the MODE key for an extended moment will enable the key-protect function as soon as the key is released.
- If using the window comparator mode, set the pressure value so that there is a difference of 3 digits, or more, between Set Value 1 (P-1) and Set Value 2 (P-2). No output will be possible with a 0 to 2 digit difference.

### Functional description

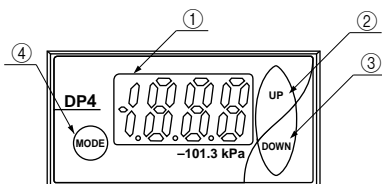

	Description	Function
①	3 1/2 digit LCD display (with red and green) backlight	<ul style="list-style-type: none"> <li>• Displays measured pressure, settings, error messages and key-protect status.</li> <li>• Red display when output is ON.</li> <li>• Green display when output is OFF.</li> </ul>
②	Increment key (UP)	<ul style="list-style-type: none"> <li>• In the initial setting mode and supplementary setting mode, pressing the key changes the setting item.</li> <li>• In the pressure value setting mode, pressing the key changes the set value.</li> <li>• In the sensing mode, pressing the key continuously for 4 sec., or more, displays the peak hold value.</li> </ul>
③	Decrement key (DOWN)	<ul style="list-style-type: none"> <li>• In the initial setting mode and supplementary setting mode, pressing the key changes the set conditions.</li> <li>• In the pressure value setting mode, pressing the key changes the set value.</li> <li>• In the sensing mode, pressing the key continuously for 4 sec., or more, displays the bottom hold value.</li> </ul>
④	Mode selection key (MODE)	<ul style="list-style-type: none"> <li>• In the pressure setting mode, pressing the key changes the setting item. In addition, if pressed for 4 sec., or more, in Set Value 1 (P-1) or Set Value 4 (P-4) setting mode, the setting mode will change to either Set Value 4 (P-4) or Set Value 1 (P-1) setting mode.</li> <li>• In the sensing mode, pressing the key continuously for 4 sec., or more, can set / cancel the key-protect.</li> <li>• In the sensing mode, pressing both Increment key and Mode selection key simultaneously changes the mode to the initial setting mode. Whereas, pressing both Decrement key and Mode selection key simultaneously changes the mode to the supplementary setting mode.</li> </ul>

In the sensing mode, if both keys are simultaneously pressed continuously, zero-point adjustment is done.

### Conditions in use for CE conformity

- The **DP4** series is a CE conformity product complying with EMC Directive. The harmonized standard with regard to immunity that applies to this product is EN 61000-6-2 (Note) and the following condition must be met to conform to that standard.

#### Condition

- The sensor should be connected less than 10 m 32.808 ft from the power supply.

Note: The EN 50082-2 that previously applied to the products for conforming to EMC Directive was replaced by EN 61000-6-2 starting April 1st, 2002.

### Error messages

- When an error occurs, take the following corrective action.

Error message	Cause	Corrective action
	Overcurrent due to short-circuit.	Switch off the power supply and check the load.
	Pressure is being applied during zero-point adjustment.	Applied pressure at the pressure port should be brought to atmospheric pressure and zero-point adjustment should be done again.
	Positive pressure and compound pressure types Applied pressure exceeds the upper limit of displayable pressure range.	Applied pressure should be brought within the rated pressure range.
	Vacuum pressure type Applied pressure exceeds the lower limit (reverse pressure) of displayable pressure range.	
	Positive pressure and compound pressure types Applied pressure exceeds the lower limit (reverse pressure) of displayable pressure range.	
	Vacuum pressure type Applied pressure exceeds the upper limit of displayable pressure range.	

### Wiring

- Make sure that the power supply is off while wiring.
- Verify that the supply voltage variation is within the rating.
- If power is supplied from a commercial switching regulator, ensure that the frame ground (F.G.) terminal of the power supply is connected to an actual ground.
- In case noise generating equipment (switching regulator, inverter motor, etc.) is used in the vicinity of this sensor, connect the frame ground (F.G.) terminal of the equipment to an actual ground.
- If the used power supply generates a surge, connect a surge absorber to the power supply to absorb the surge.
- Do not run the wires together with high-voltage lines or power lines or put them in the same raceway. This can cause malfunction due to induction.
- In order to reduce noise, make the wiring as short as possible.

### Others

- Use within the rated pressure range.
- Do not apply pressure exceeding the pressure withstandability value. The diaphragm will get damaged and correct operation shall not be maintained.
- Do not use during the initial transient time (3 sec. approx.) after the power supply is switched on.
- Avoid dust, dirt, and steam.
- Take care that the sensor does not come in direct contact with water, oil, grease, or organic solvents, such as, thinner, etc.
- Do not insert wires, etc., into the pressure port. The diaphragm will get damaged and correct operation shall not be maintained.
- Do not operate the keys with pointed or sharp objects.

# DP4

## PRECAUTIONS FOR PROPER USE

### Setting

- If key-protect has been set, make sure to release key-protect before operating the keys.  
(Please refer to 'Key-protect function' on p.787 for the procedure.)
- Set Value 1 (P-1) and Set Value 2 (P-2) can be made common for all the output modes.
- The setting of Set Value 2 (P-2) with respect to Set Value 1 (P-1) can only be towards the high pressure side in case of the positive pressure type sensor and only towards the high vacuum side in case of the vacuum pressure type sensor.
- The conditions which are set are stored in an EEPROM. Kindly note that the EEPROM has a life span and its guaranteed life is 100,000 write operation cycles.

### Setting procedure

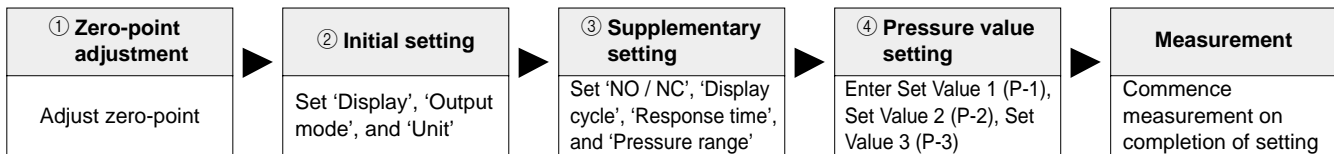

#### ① Zero-point adjustment

- The displayed pressure when the pressure port is left open is adjusted to zero.
- The sensor will automatically enter the sensing mode when power is supplied.
- Let the pressure port be at atmospheric pressure (i.e., no applied pressure condition), and press, simultaneously, the UP and DOWN keys continuously.
- **0000** is displayed and, when the fingers are released, zero-point adjustment is completed and the sensor returns to the sensing mode.

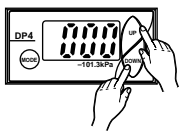

#### ② Initial setting

- Pressure 'Unit', 'Display', and 'Output mode' of the outputs are set.
- In the sensing mode, press **MODE** key while pressing UP key.
- Initial setting is displayed.
- If sensor is being used for the first time, **PHH** is displayed.
- The settable digit blinks.
- The settable digit changes when UP key is pressed and the setting is changed when DOWN key is pressed.

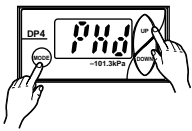

#### ③ Supplementary setting

- 'NO / NC', 'Display cycle', 'Response time' and 'Pressure range' are set.
- In the sensing mode, press both DOWN key and **MODE** key simultaneously.
- The setting item and the setting condition are displayed alternately.
- The setting item changes when UP key is pressed.
- The set condition of each item changes when DOWN key is pressed.

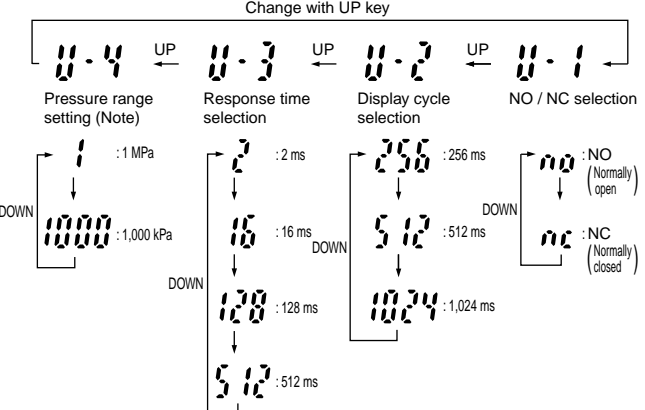
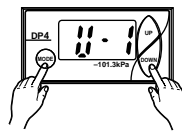

Note: Displayable only for positive pressure type DP4-52(P).

#### ④ Pressure value setting

- Sets output to Set Value 1 to 3 (P-1 to P-3).
- Press the **MODE** key in sensing mode.
- The mode changes in the order Set Value 1 (P-1) setting mode, Set Value 2 (P-2) setting mode and Set Value 3 (P-3) setting mode each time the **MODE** key is pressed.

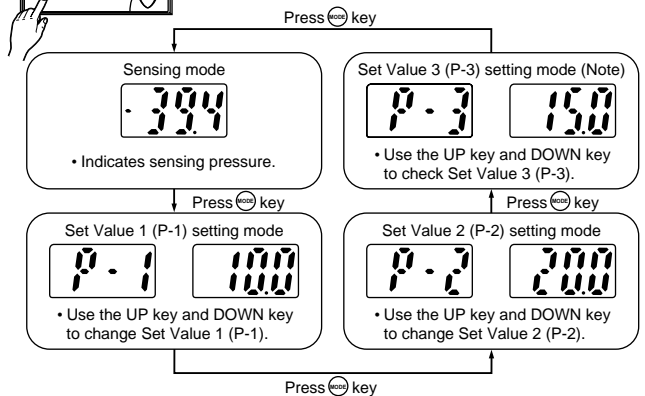
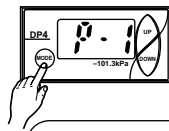

Note: Set Value 3 is only displayed when automatic sensitivity setting mode has been set. Furthermore, if Set Value 3 is between Set Value 1 and Set Value 2, the UP key and DOWN key can be used to correct it.

## PRECAUTIONS FOR PROPER USE

### Forced output mode

- In the initial setting mode, if the output mode is set to the forced output mode ( ), the output is forcibly maintained at OFF level in the sensing mode, irrespective of Set Value 1 to 3 (P-1 to P-3).

Further, if the keys are operated as per the procedure given below, the output can be forcibly switched either ON or OFF without applying pressure at the pressure port. This is convenient for an operation check of the comparative output or for an inspection before commencing work.

( The diagram below appears when the **DP4-50(P)** has been used to set the display to 'Digital display' ( ). )

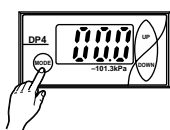

- In the sensing mode, press key to change to the forced output mode.
- Whenever UP key is pressed, the output state switches to either ON and OFF alternately.
- Press key to return to the sensing mode.

- Output is kept off at the point where the mode is changed from another output mode to forced output control mode ( ).
- Even if output has been set to stay on during forced output control mode, it will be forcibly changed to off at the point where the mode changes back to sensing mode.

### Memory bank function

- The memory bank function is a function which allows two types of output to be stored: Set Values 1 to 3 (P-1 to P-3) and Set Values 4 to 6 (P-4 to P-6).

This make it possible to change set values quickly.

- If the key is pressed in a sensing mode other than forced output mode, the mode will change to pressure value setting mode.

- After releasing the mode select key, press the key again continuously until is displayed (4 sec. or more).

- Make the setting for Set Values 4 to 6 (P-4 to P-6). Set Values 4 to 6 (P-4 to P-6) correspond to Set Values 1 to 3 (P-1 to P-3) respectively. Refer to ④ **Pressure value setting** on p.786 for details on making each setting.

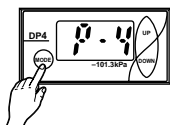

### Peak hold & bottom hold functions

- Peak hold and bottom hold functions enable the display of the peak value (maximum pressure value) and the bottom value (minimum pressure value) of the varying measured pressure.

These functions are convenient for finding the pressure variation range or for determining the reference for pressure settings.

- Please note that the peak value and the bottom value data is erased when it is no longer displayed.

#### Peak hold display

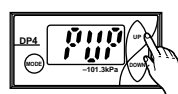

↑  
Displayed alternately

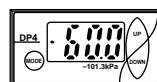

- In the sensing mode, keep UP key pressed until is displayed. (4 sec. or more)
- When the finger is released after is displayed, the peak value and are displayed alternately.
- Press UP key to return to the sensing mode.

( If the applied pressure exceed the display pressure range, an error display ( ) will alternate with the display. When this occur, return the applied pressure to the rated pressure range.  
• The illustration on the left shows the vacuum pressure type. )

#### Bottom hold display

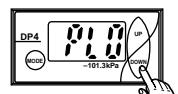

↑  
Displayed alternately

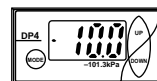

- In the sensing mode, keep DOWN key pressed until is displayed. (4 sec. or more)
- When the finger is released after is displayed, the bottom value and are displayed alternately.
- Press DOWN key to return to the sensing mode.

( If the applied pressure exceed the display pressure range, an error display ( ) will alternate with the display. When this occur, return the applied pressure to the rated pressure range.  
• The illustration on the left shows the vacuum pressure type. )

### Key-protect function

- Key-protect is a function which prevents any unintentional change in the conditions which have been entered in each setting mode by making the sensor not to respond to the key operations.

#### Setting of key-protect

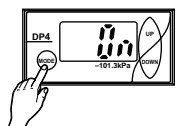

- In the sensing mode, press key continuously for 4 sec. or more, and release it immediately when is displayed.

( Key-protect is set and the sensor returns to the sensing mode. )

- Since the key-protect information is stored in an EEPROM, it is not erased even if the power supply is switched off.
- Please take care to remember if the key-protect function has been set.

#### Release of key-protect

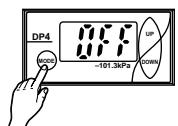

- In the sensing mode, press key continuously for 4 sec. or more, and release it immediately when is displayed.

( Key-protect is released and the sensor returns to the sensing mode. )

- When the keys are to be operated, make sure that key-protect is released.



# DP4

## PRECAUTIONS FOR PROPER USE

### Piping

- When connecting a commercial M5 coupling to the pressure port, hold the flat sides of the pressure port with a 13 mm 0.512 in spanner and make sure that the tightening torque is 1N·m or less. If excessive tightening torque is applied, the commercial fitting may break.

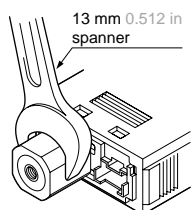

### Mounting

- Install the enclosed panel mounting bracket (**MS-DP-1**) as shown in the figure below. The tightening torque should be 0.15 N·m or less. Further, tighten both the right and the left screw gradually and equally, so that the panel mounting bracket does not tilt.

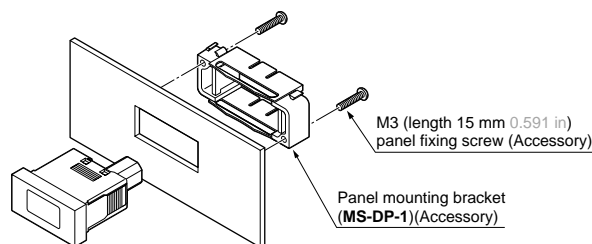

**DIMENSIONS (Unit: mm in)** The CAD data in the dimensions can be downloaded from the SUNX website: <http://www.sunx.co.jp/>

### DP4-5 □ Sensor

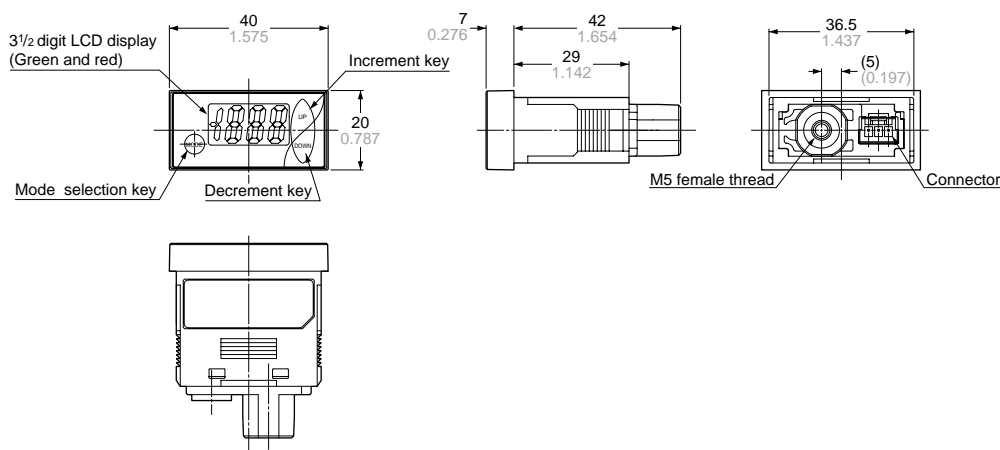

### MS-DP-2 DIN rail mounting bracket (Optional)

#### Assembly dimensions

##### <Horizontal mounting>

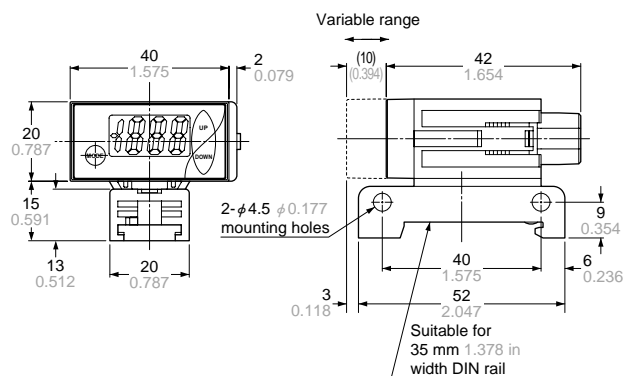

##### <Vertical mounting>

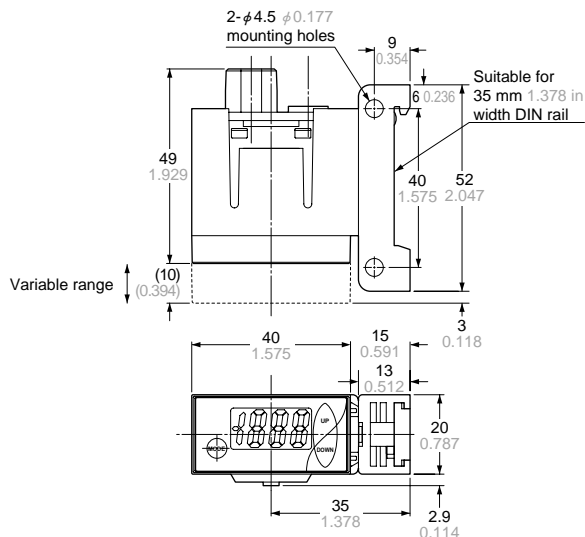

**DIMENSIONS (Unit: mm in)** The CAD data in the dimensions can be downloaded from the SUNX website: <http://www.sunx.co.jp/>

## MS-DP-1 Panel mounting bracket (Accessory)

### Assembly dimensions

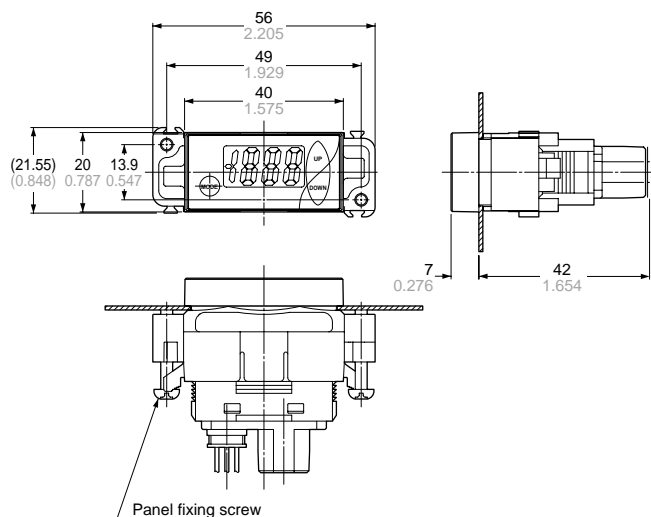

Material: POM

Two M3 (length 15 mm 0.591 in) screws for fitting are attached

### Panel cut-out dimensions

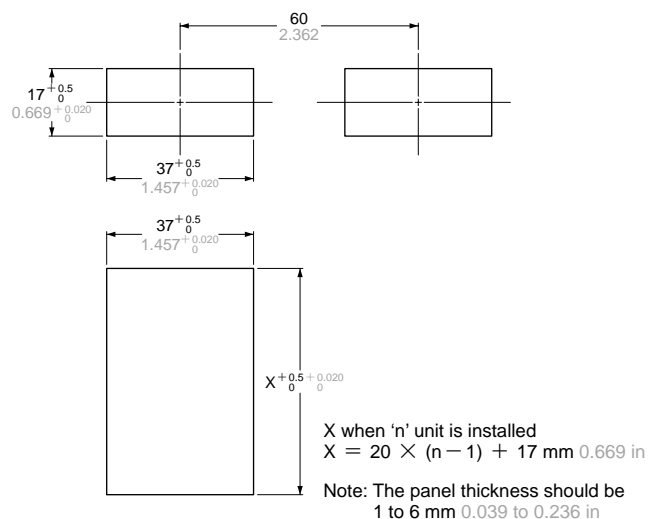

## MS-DP-5 Horizontal multiple panel mounting bracket (Optional)

### Assembly dimensions

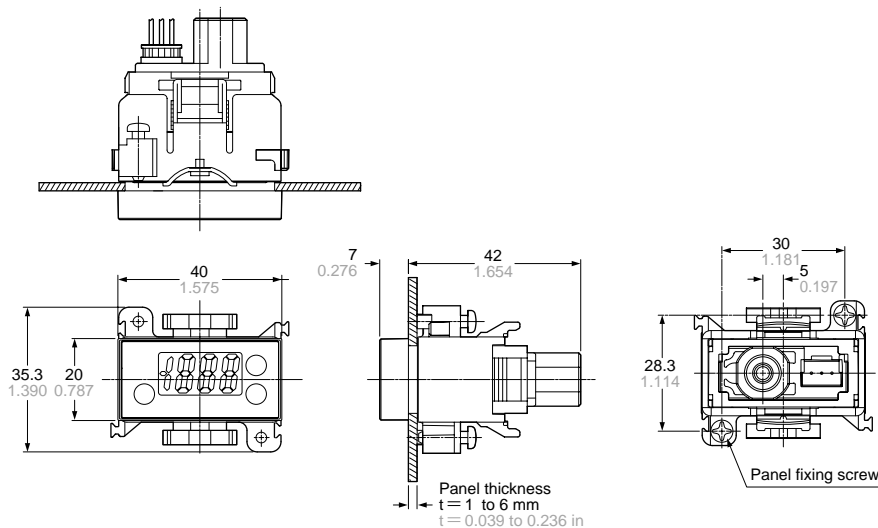

### Panel cut-out dimensions

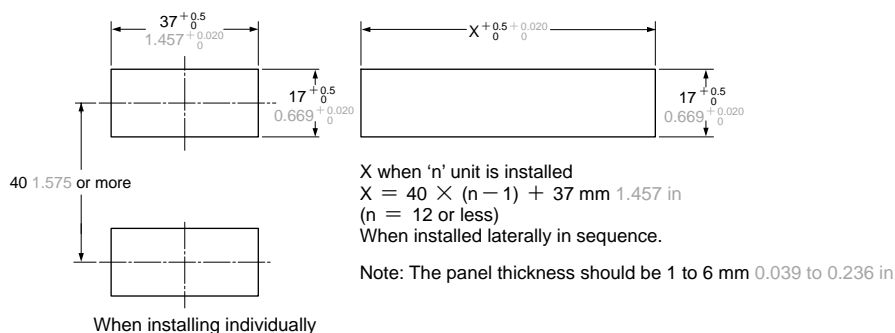

**DIMENSIONS (Unit: mm in)** The CAD data in the dimensions can be downloaded from the SUNX website: <http://www.sunx.co.jp/>

## MS-DP-3 Sensor mounting bracket (Optional)

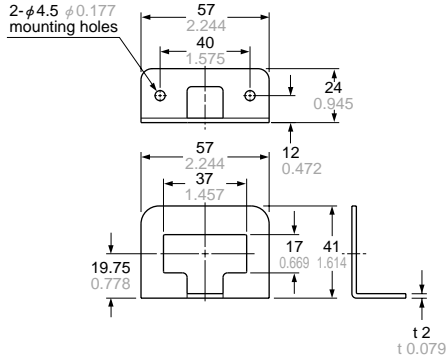

Material: Cold rolled carbon steel (SPCC)(nickel plated)

Note: Use with the panel mounting bracket (MS-DP-1) included with the sensor.

## MS-DP-4 Sensor mounting bracket (Optional)

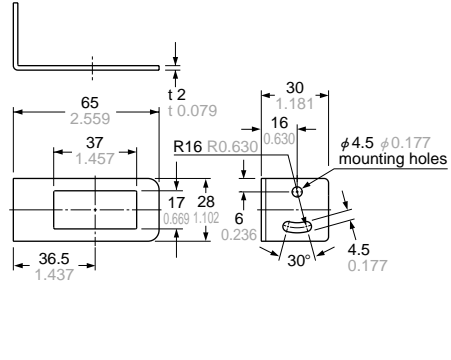

Material: Cold rolled carbon steel (SPCC)(nickel plated)

Note: Use with the panel mounting bracket (MS-DP-1) included with the sensor.

## CN-63 Connector (Optional)

### <Housing>

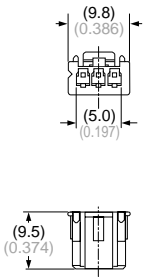

### <Connector bracket>

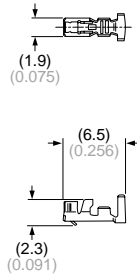

Mating connector  
 Connector pin: BXA-001T-P0.6 manufactured by JST Mfg. Co., Ltd.  
 Housing: XAP-03V-1 manufactured by JST Mfg. Co., Ltd.  
 Crimping tool  
 YC-690R manufactured by JST Mfg. Co., Ltd.

## CN-63-C2 CN-63-C5 Connector attached cable (Optional)

